



Surgical Instruments

www.mohsangroup.com



Mohsan Surgical Industries

Butt Lodge, Daska Road, Haji Pura

Sialkot 51310 - Pakistan

Tel: +92 524 601559

e-mail: info@mohsangroup.com

web: www.mohsangroup.com

INTRODUCTION

In 1972 Mohsan Surgical was established with the sole aim to export high Quality surgical, dental, beauty Instruments. Under the banner of Mohsan Surgical our products were advertised throughout the world by the help of catalogues, brochures and personal visits to different countries across the world. These efforts bore fruit and we managed to establish our credibility and began exporting quality instruments globally.

We achieved tremendous success by virtue of constant dedicated efforts, devotion to duty and maintenance of quality control. This quality management system was properly implemented and is being successfully executed at all production stages. This QMS enables us to control and prevent unforeseen circumstances at every stage of production and export.

Keeping in view the universal quality standards, we are fortunate to obtain cGMP certificate (Basic requirement of FDA for export to the United States of America) and also achieved the landmark certification of ISO-9001: 2000. Regular frequent COC audits are carried out by experienced auditors.

Its been almost 40 Years of dedicated service which has earned trust and reputation to us in this field. And as being a manufacturer we have ability, knowledge, infrastructure and compliance to design & manufacture instruments as per the needs and requirements of our respective buyers/clients. The customer satisfaction is what we always strive for as we believe the customer is a King in this capital society.

MISSION STATEMENT

"To become a Global Company by providing our valuable customers the best quality products and prompt services through product innovation, development and acquisition of technology. The satisfaction of our customers and employees is a major part of our mission."



Contents

01	Diagnostics Diagnose Diagnósticos	001 - 006
02	Scalpels Skalpelle Escalpelos	007 - 016
03	Scissors Schere Tijeras	017 - 066
04	Artery Forceps Arterienklemme Pinzas Arteriales	067 - 109
05	Forceps Pinzetten Pinzas	011 - 148
06	Ophthalmology Ophthamologie Oftalmología	149 - 190
07	Suture Naht Sutura	191 - 223
08	Cotton Swab Forceps Tupfer - und Kornzangen Pinzas para Topones y Curaciones	225 - 237

Contents

09	Retractors Wundhaken und - Sperrer Separadores	239 - 297
10	Otology Otologie Otología	299 - 321
11	Rhinology Rhinologie Rinología	323 - 346
12	Mouth and Tongue Mund und Zunge Boca y lengua	347 - 374
13	Gynecology Gynäkologie Ginecología	375 - 407
14	Obstetrics Geburtshilfe Obstetricia	409 - 415
15	Probes Sonden Sondas	417 - 419
16	Cardiovascular Herz - und Gefabchirurgie Cirugia Cardiovascular	421 - 472

Contents

17	Anaesthesia Narkose Anestesia	473 - 477
18	Bone Surgery Knochenchirurgie Cirugía ósea	479 - 507
19	Dressing Verband, Gips Vendajes	509 - 515
20	Intestines, Stomach, Rectum Darm, Magen, Masdarm Intestinos, Estómago, Recto	517 - 523
21	Neurosurgery and Laminectomy Neurochirurgie und Laminektomie Neurocirugía y Laminectomía	525 - 549
22	Dermatology - Hygiene Dermatologie - Hygiene Dermatología - Hygiene	551 - 556
23	Sterilization Sterilisation Esterilización	557 - 564



01

Diagnostics
Diagnose
Diagnósticos



BERLINER
01-010-20
20 cm



TAYLOR
01-012-20
20 cm



TRAUBE
01-014-17
17 cm

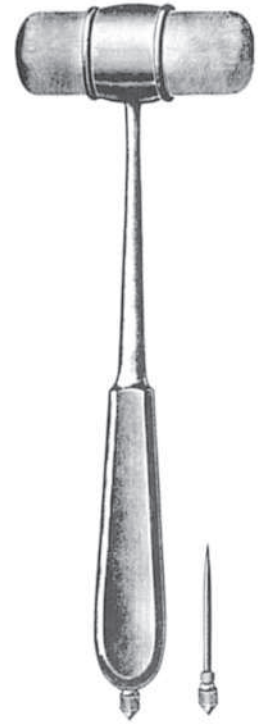

DEJERINE
01-016-21
21 cm



DEJERINE
01-018-20
20 cm

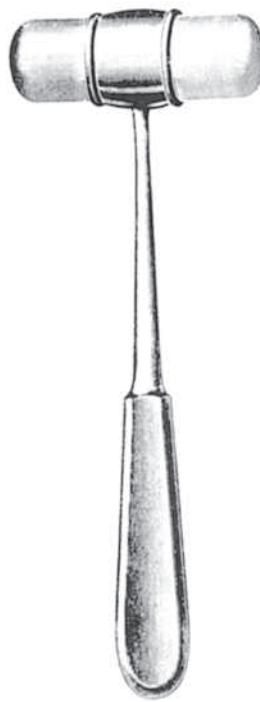

DEJERINE
01-020-20
20 cm



TROEMNER
01-022-25
25 cm

Aluminium



PINARD
 01-024-15
 15 cm



PINARD
 01-026-14
 14 cm

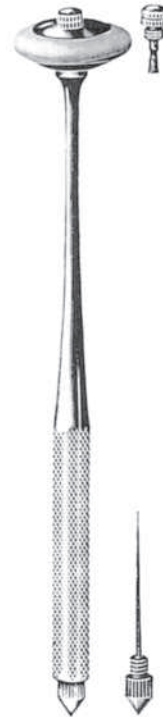

RABINER
 01-028-23
 23 cm



EPSTEIN
 01-030-18
 18 cm



BABINSKI
 01-032-22
 22 cm



BABINSKI
 01-034-22
 22 cm



BUCK
 01-036-18
 18 cm



01-038-15
OTOSCOPE SET



01-040-00

UNIVERSAL DIAGNOSTIC SET FOR ENT & EYE



02

Scalpels
Skalpelle
Escalpelos



02.0010.16
16 cm



02-012-07
no. 7



02-014-07
no. 7k



02-016-03
no. 3L



02-018-03
no. 3LA

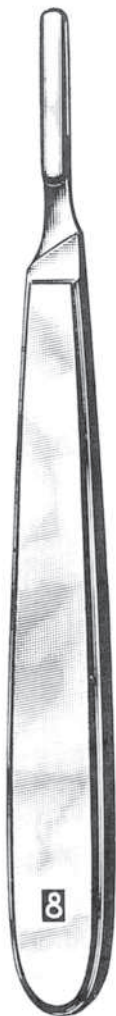
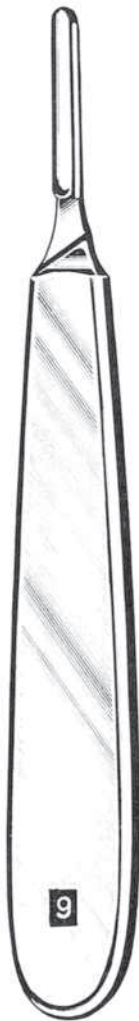

02-020-22
22.5 cm

02-022-08
no. 802-024-09
no. 902-026-03
no. 302-028-04
no. 4



02-030-22
22.5 cm



02-032-04
no. 4L



02-034-04
no. 4LA



CATLIN
 02-036-23 23 cm
 cutting length: 11 cm



COLLIN
 02-038-27 27 cm
 cutting length: 15 cm

02-041-36 36 cm
 cutting length: 22 cm



CATLIN
 02-041-16
 cutting length: 16 cm

02-042-22
 cutting length: 22 cm



02-044-26 26 cm
 cutting length: 13 cm

02-045-29 29 cm
 cutting length: 16 cm

02-046-32 32 cm
 cutting length: 19 cm

02-047-35 35 cm
 cutting length: 22 cm



02-050-18
Fig-1



02-051-18
Fig-2

LANGENBECK
 02-050-18 - 02-051-18
 18 cm

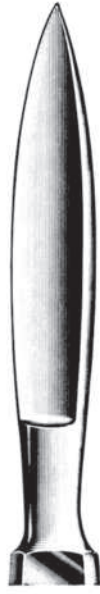

02-053-16
Fig-1

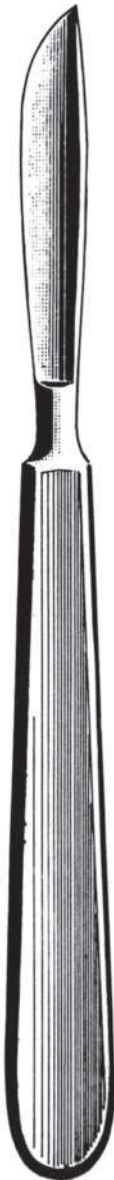

COLLIN
 02-053-16 - 02-058-16
 16 cm



02-054-16
Fig-2



02-056-16
Fig-4



02-055-16
Fig-3



41-057-16
Fig-5



02-058-16
Fig-6



LISTON
 02-060-24 24 cm
 cutting length: 10.5 cm



02-062-14
 Fig-1



02-063-14
 Fig-2



02-064-14
 Fig-3



02-065-14
 Fig-4



BERGMANN
 02-062-14 - 02-065-14
 14 cm



02-067-13
 Fig-1



02-068-13
 Fig-2



02-069-13
 Fig-3



02-070-13
 Fig-4



02-071-13
 Fig-5



02-067-13 - 02-071-13
 13.5 cm



DIEFFENBACH
02-073-16 - 02-081-16
16 cm



02-073-16
Fig-1



02-074-16
Fig-2



02-075-16
Fig-3



02-076-16
Fig-4



02-077-16
Fig-5



02-078-16
Fig-6



02-079-16
Fig-7



02-080-16
Fig-8



02-081-16
Fig-9



ADAMS
 02-083-14 - 02-084-14
 14 cm



02-083-14
 Fig-1



02-084-14
 Fig-2



ADAMS
 02-086-15 - 02-089-15
 15 cm



02-086-15
 Fig-1



02-087-15
 Fig-2



02-088-15
 Fig-3



02-089-15
 Fig-4



02-091-13 - 02-098-13
 13 cm



02-091-13
 Fig-1



02-092-13
 Fig-2



02-093-13
 Fig-3



02-094-13
 Fig-4



02-095-13
 Fig-5



02-096-13
 Fig-6



02-097-13
 Fig-7



02-098-13
 Fig-8



03

Scissors
Schere
Tijeras



- 03-010-10 10.5 cm
- 03-011-11 11 cm
- 03-012-13 13 cm
- 03-013-14 14.5cm
- 03-014-15 15 cm
- 03-015-16 16.5 cm
- 03-016-17 17.5 cm
- 03-017-18 18.5 cm

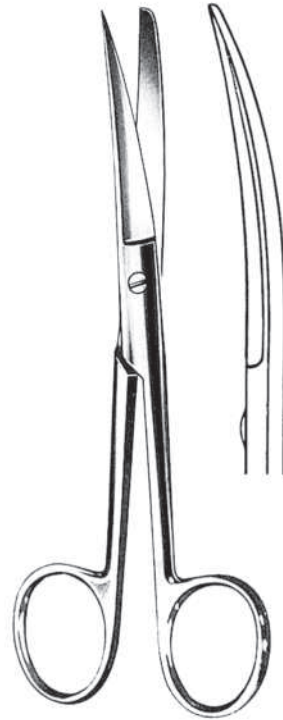

- 03-019-10 10.5 cm
- 03-020-11 11.5 cm
- 03-021-13 13 cm
- 03-022-14 14.5cm
- 03-023-15 15 cm
- 03-024-16 16.5 cm
- 03-025-17 17.5 cm
- 03-026-18 18.5 cm



- 03-028-13 13 cm
- 03-029-14 14.5 cm

Delicate Model

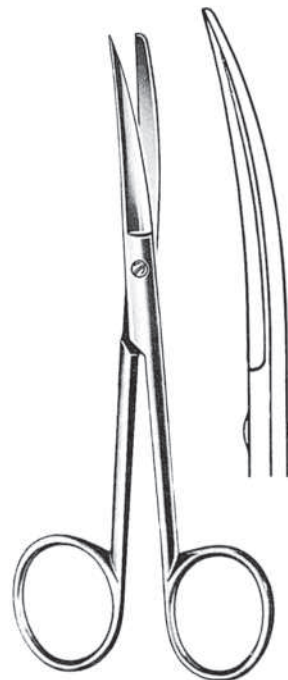

- 03-031-13 13 cm
- 03-032-14 14.5 cm



- 03-034-10 10.5 cm
- 03-035-11 11 cm
- 03-036-13 13 cm
- 03-037-14 14.5cm
- 03-038-15 15 cm
- 03-039-16 16.5 cm
- 03-040-18 18.5 cm



- 03-059-10 10.5 cm
- 03-060-11 11 cm
- 03-061-13 13 cm
- 03-052-14 14.5cm
- 03-063-15 15 cm
- 03-064-16 16.5 cm
- 03-065-17 17.5 cm
- 03-066-18 18.5 cm



- 03-050-10 10.5 cm
- 03-051-11 11 cm
- 03-052-13 13 cm
- 03-053-14 14.5cm
- 03-054-15 15 cm
- 03-055-16 16.5 cm
- 03-056-17 17.5 cm
- 03-057-18 18.5 cm



- 03-042-10 10.5 cm
- 03-043-11 11 cm
- 03-044-13 13 cm
- 03-045-14 14.5cm
- 03-046-15 15 cm
- 03-047-16 16.5 cm
- 03-048-18 18.5 cm

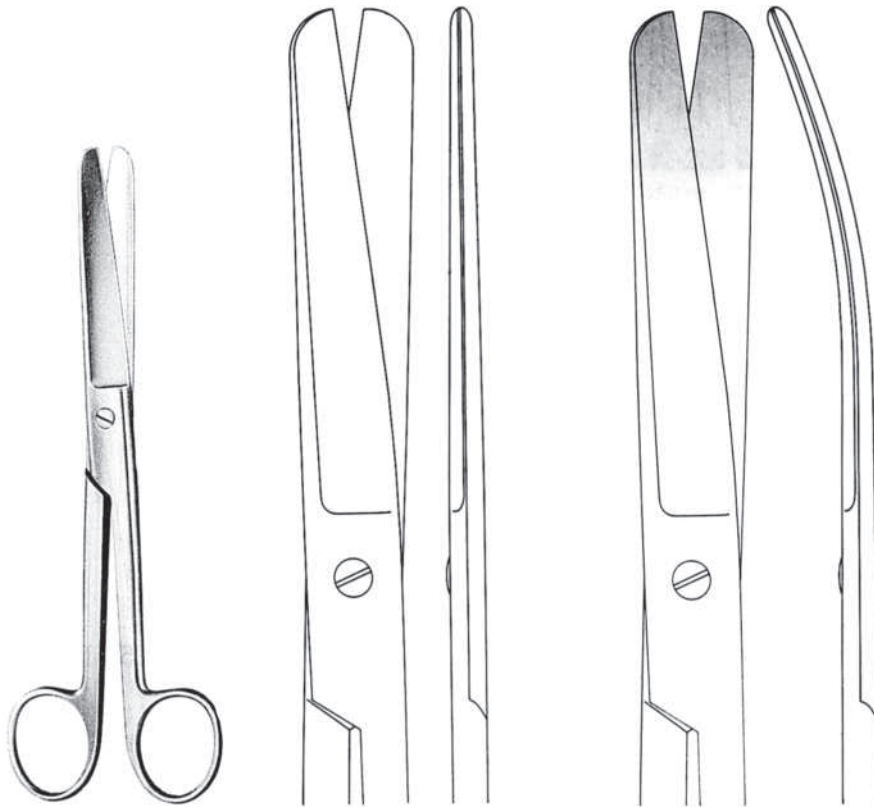

DOYEN
03-068-17 - 03-069-17
17 cm

03-068-17

03-069-17

Round Pattern

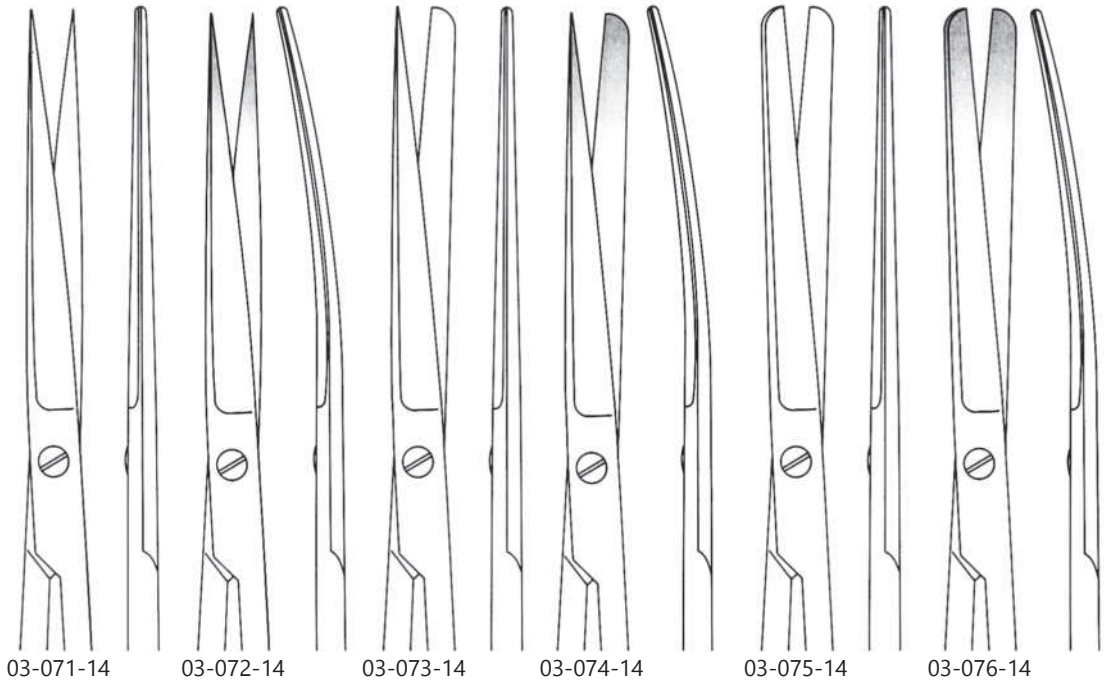

03-071-14

03-072-14

03-073-14

03-074-14

03-075-14

03-076-14

GRAZIL
03-071-14 - 03-076-14
14.5 cm

03

Operating Scissors
Schere bedienen
Tijeras Operativas



STANDARD
03-078-10 - 03-085-20

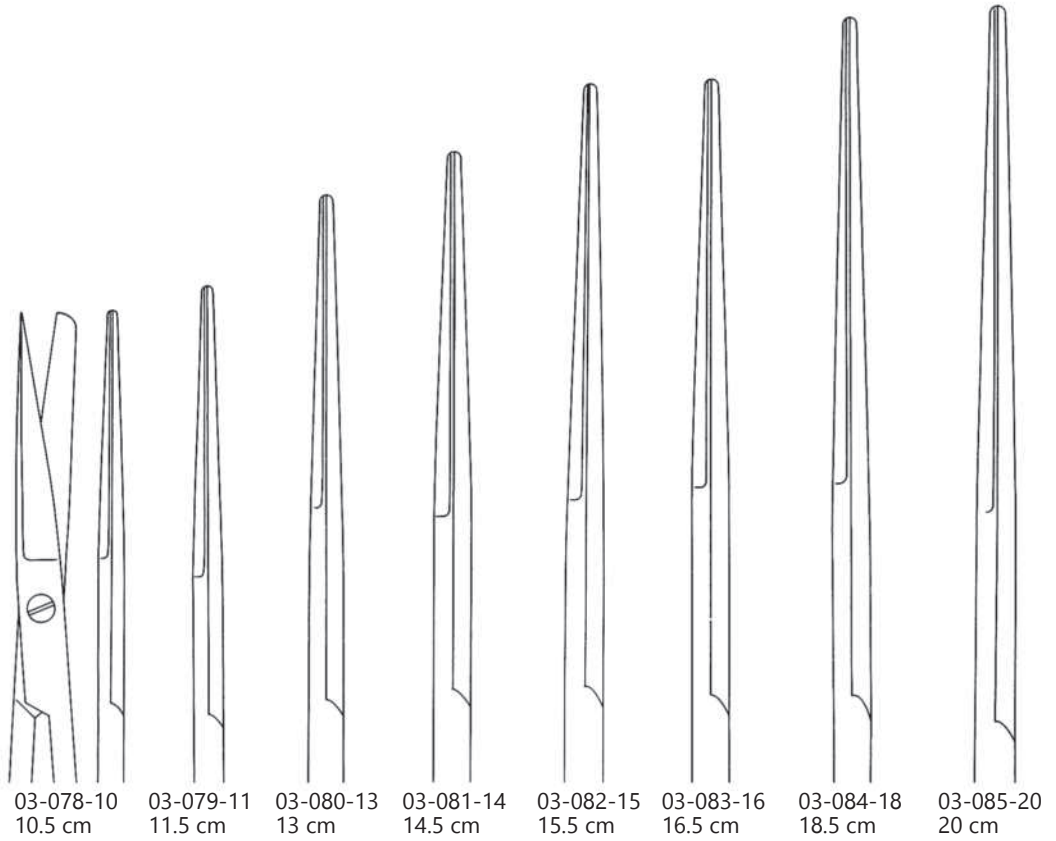

STANDARD
03-087-11 - 03-093-20

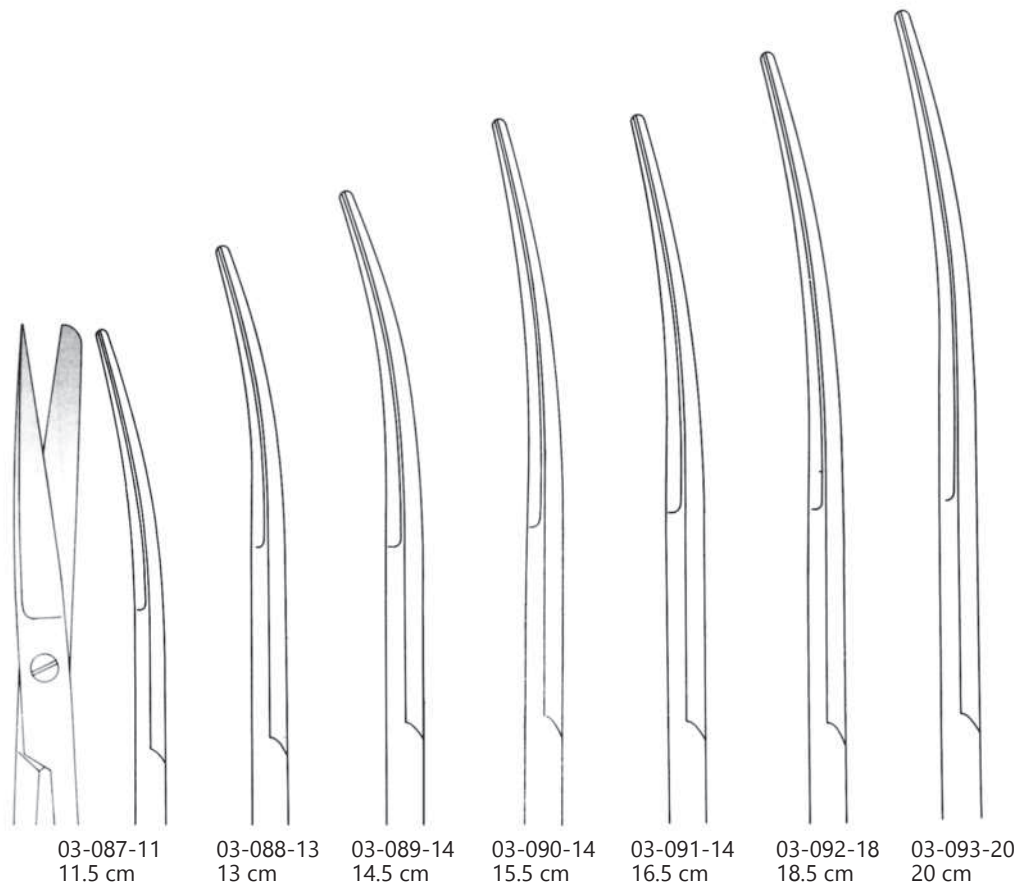

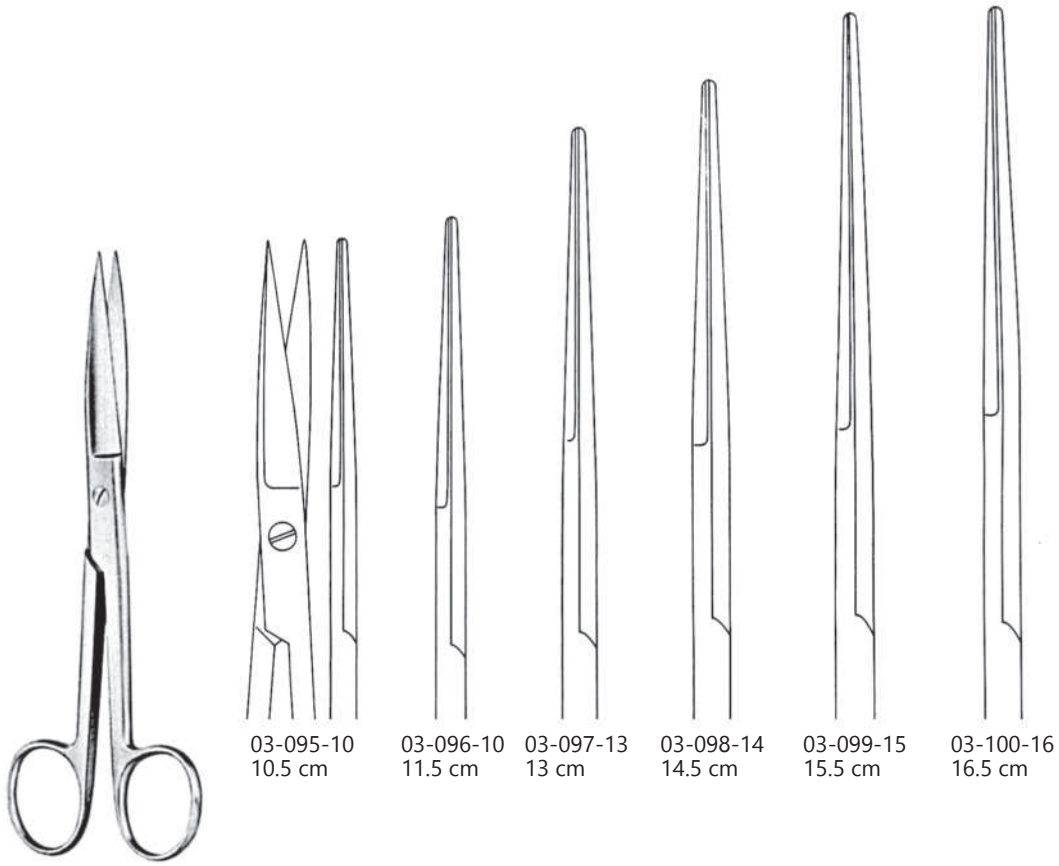

03-095-10
10.5 cm

03-096-10
11.5 cm

03-097-13
13 cm

03-098-14
14.5 cm

03-099-15
15.5 cm

03-100-16
16.5 cm

STANDARD
03-095-10 - 03-100-16

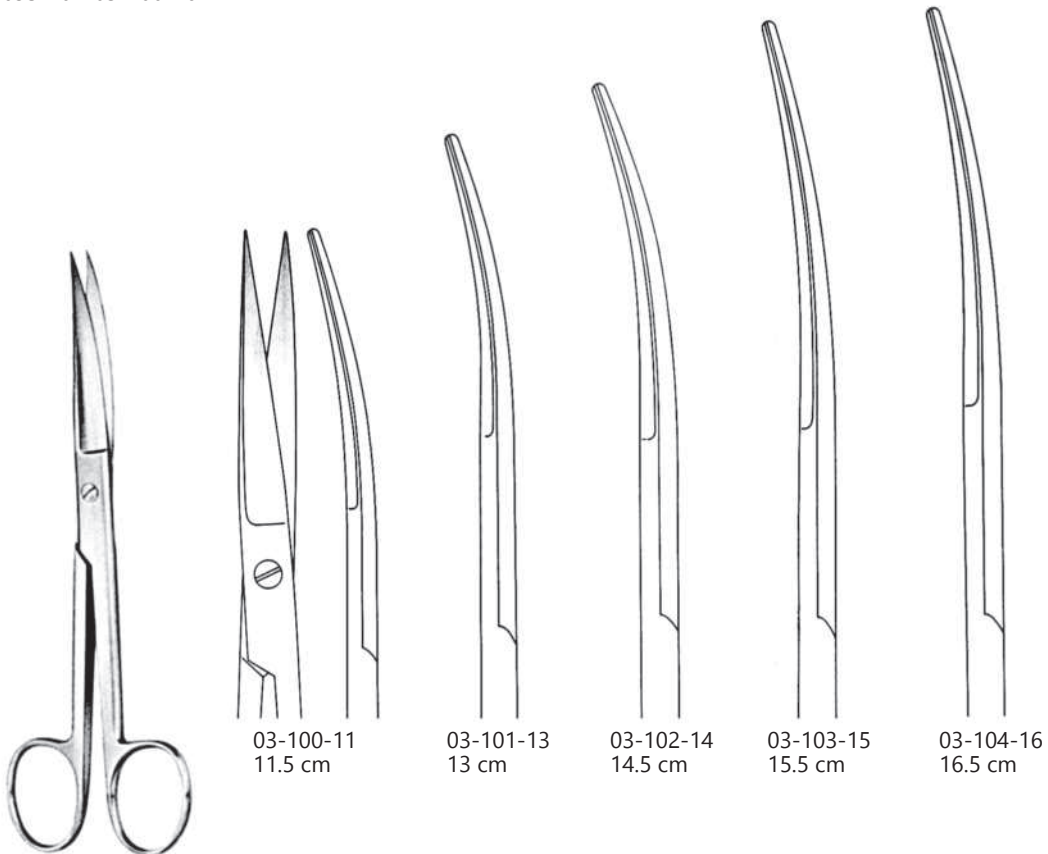

03-100-11
11.5 cm

03-101-13
13 cm

03-102-14
14.5 cm

03-103-15
15.5 cm

03-104-16
16.5 cm

STANDARD
03-100-11 - 03-104-16



STANDARD
03-106-10 - 03-111-16



03-106-10
10.5 cm



03-107-11
11.5 cm



03-108-13
13 cm



03-109-14
14.5 cm



03-110-15
15.5 cm



03-111-16
16.5 cm



STANDARD
03-113-11 - 03-117-16

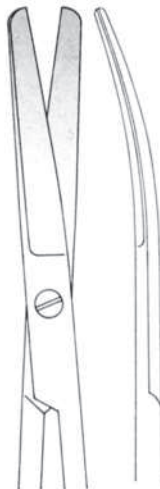

03-113-11
11.5 cm



03-114-13
13 cm



03-115-14
14.5 cm



03-116-15
15.5 cm



03-117-16
16.5 cm

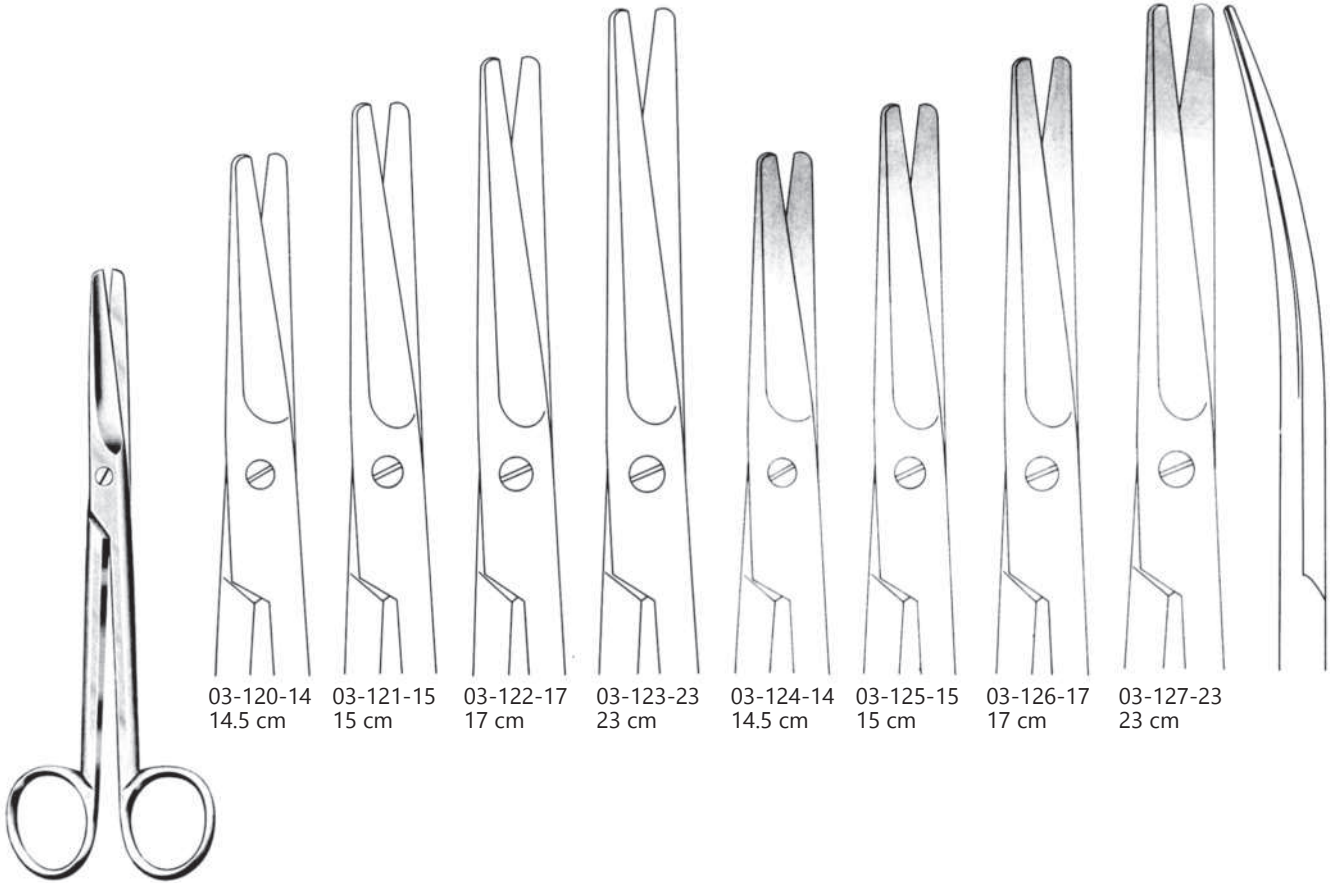

03-120-14
14.5 cm

03-121-15
15 cm

03-122-17
17 cm

03-123-23
23 cm

03-124-14
14.5 cm

03-125-15
15 cm

03-126-17
17 cm

03-127-23
23 cm

MAYO
03-120-14 - 03-127-23

Round Pattern



MAYO
03-129-14 - 03-132-23



03-129-14 14 cm
03-130-15 15 cm
03-131-17 17 cm
03-132-23 23 cm



MAYO
03-134-14 - 03-137-23



03-134-14 14 cm
03-135-15 15 cm
03-136-17 17 cm
03-137-23 23 cm



MAYO-STILLE
03-139-15 - 03-142-17



03-139-15
15 cm



03-140-17
17 cm



03-141-15
15 cm



03-142-17
17 cm



MAYO-STILLE
03-144-18 - 03-149-21

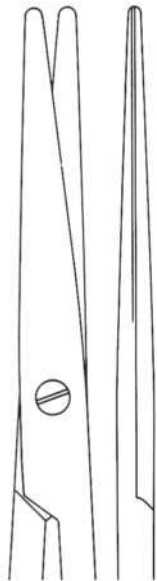

03-144-16
16 cm



03-145-19
19 cm



03-146-21
21 cm



03-147-16
16 cm



03-148-19
19 cm



03-149-21
21 cm

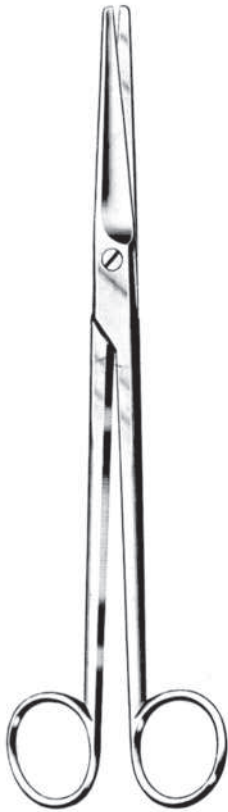

MAYO-HARRINGTON
03-151-22 - 03-153-30

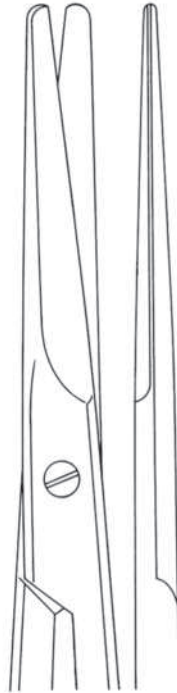

03-151-22
22.5 cm



03-152-22
22.5 cm



03-153-30
30 cm

Round Pattern



MAYO-HARRINGTON
03-155-22 20 cm
03-156-23 23 cm

Round Pattern



MAYO-HARRINGTON
03-158-20 20 cm
03-160-23 23 cm

Round Pattern



JORGENSON
03-162-23 23 cm



MAYO-NOBLE
03-164-14 14 cm
03-165-17 17 cm



MAYO-NOBLE
03-167-14 14 cm
03-169-17 17 cm



LISTER
03-171-14 14 cm
03-172-18 18 cm
03-173-20 20 CM

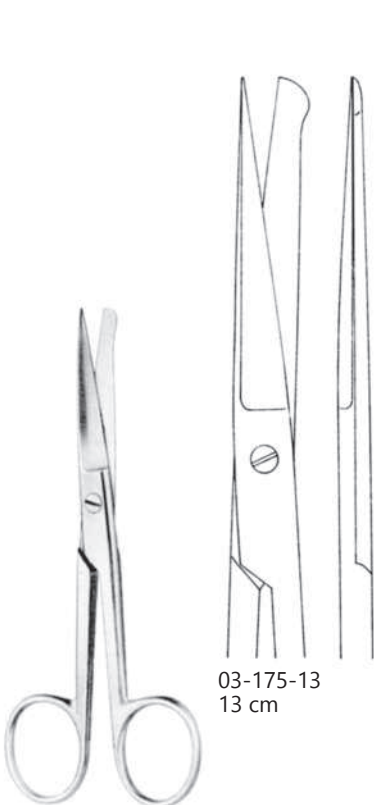
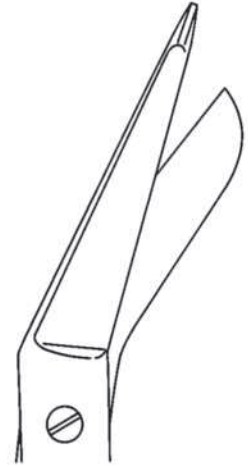

03-175-13
13 cm

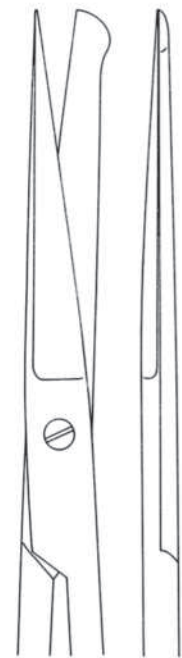

03-176-14
14 cm



03-178-14
14 cm

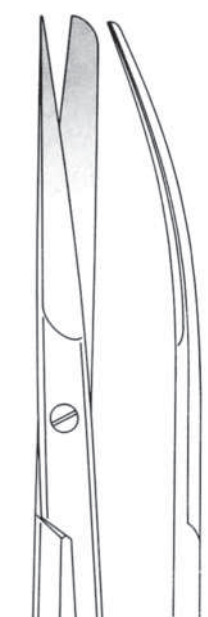

03-179-14
14 cm

INCISIONS
03-175-13 - 03-176-17.14

DEAVER
03-178-14 - 03-179-17.14

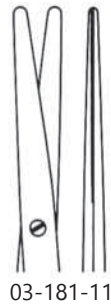

METZENBAUM
 03-181-11 - 03-182-11
 11.5 cm



METZENBAUM
 03-184-15 - 03-185-15
 15 cm

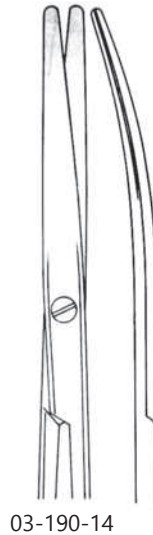
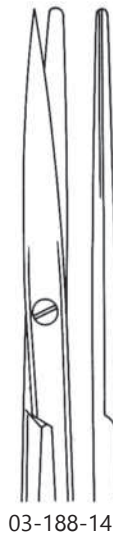
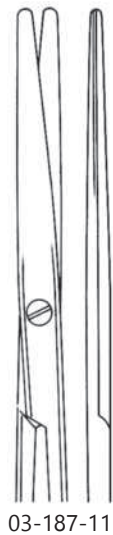

METZENBAUM
 03-187-14 - 03-192-14
 14.5 cm



METZENBAUM
03-194-18 18 cm
03-195-20 20 cm

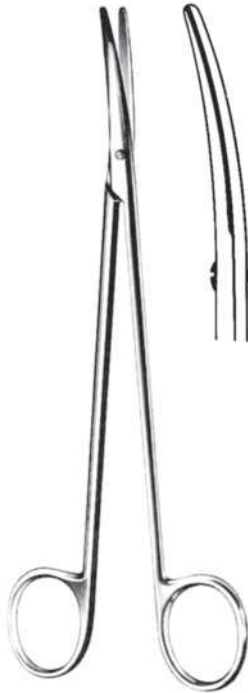

METZENBAUM
03-197-18 18 cm
03-198-20 20 cm



METZENBAUM(LAHEY)
03-200-14
14 cm



METZENBAUM(LAHEY)
03-202-14
14 cm

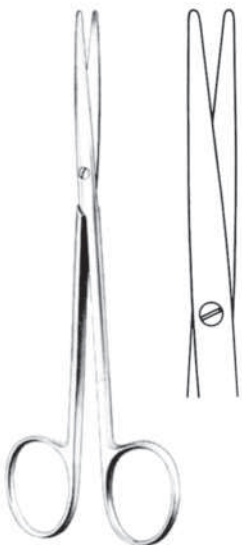

METZENBAUM-FINO
03-204-14
14.5 cm



METZENBAUM-FINO
03-206-14
14.5 cm



METZENBAUM-FINO
03-208-14
14.5 cm



METZENBAUM-FINO
03-210-14
14.5 cm

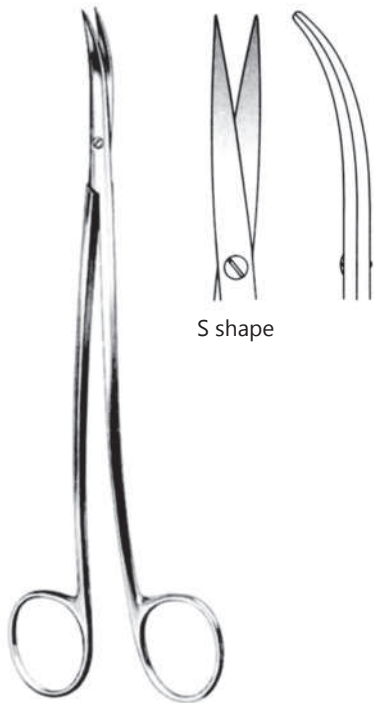

METZENBAUM-FINO
 03-212-18 18 cm
 03-213-20 20 cm
 03-214-23 23 cm

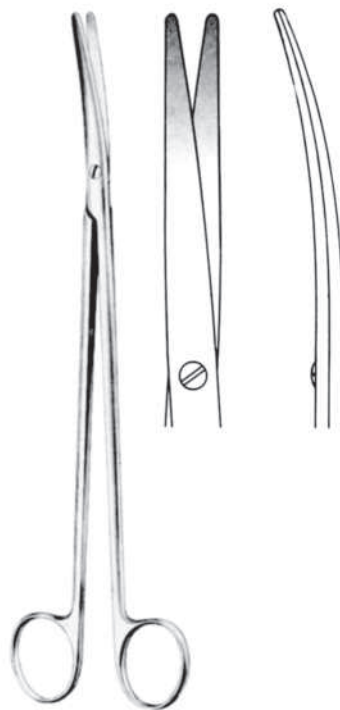

METZENBAUM-FINO
 03-216-18 18 cm
 03-217-20 20 cm
 03-218-23 23 cm

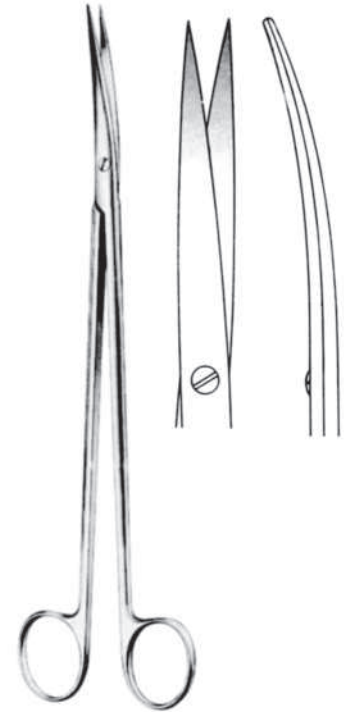

METZENBAUM-FINO
 03-220-18 18 cm
 03-221-20 20 cm
 03-222-23 23 cm

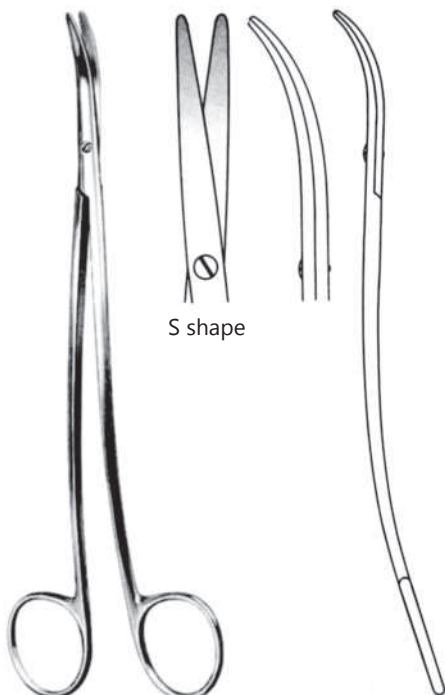

METZENBAUM-FINO
 03-224-18 18 cm
 03-225-20 20 cm
 03-226-23 23 cm

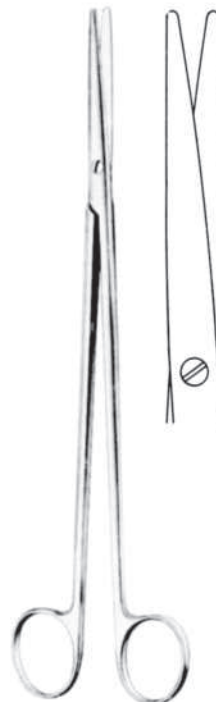

METZENBAUM-FINO
 03-228-18 18 cm
 03-229-20 20 cm
 03-230-23 23 cm

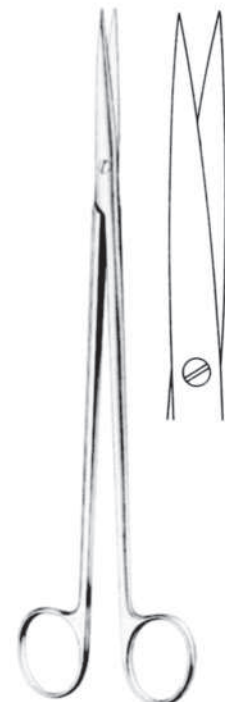

METZENBAUM-FINO
 03-232-18 18 cm
 03-233-20 20 cm
 03-234-23 23 cm



LEXER
 03-236-16 - 03-242-21

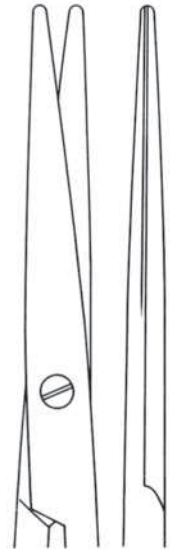

03-236-16
 16 cm



03-238-16
 16 cm

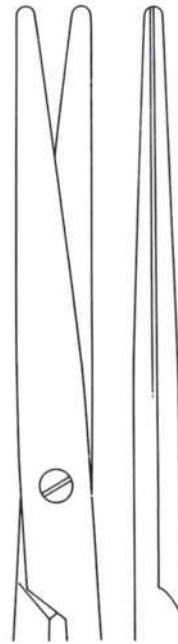

03-240-21
 21 cm

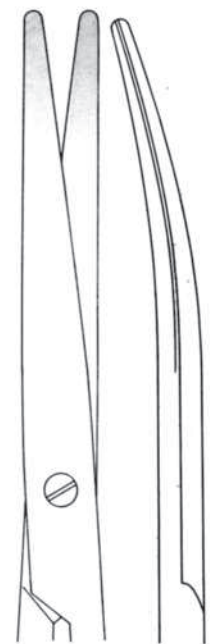

03-242-21
 21 cm



LEXER-FINO
 03-244-16
 16 cm

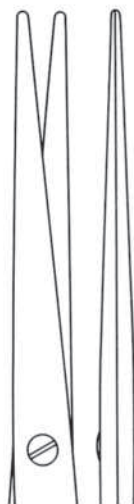

LEXER-FINO
 03-246-16
 16 cm

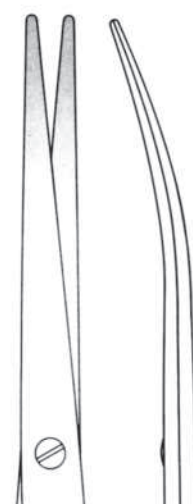



03-248-11

03-249-11

STEVENS
03-248-11 - 03-249-11
11 cm
blunt

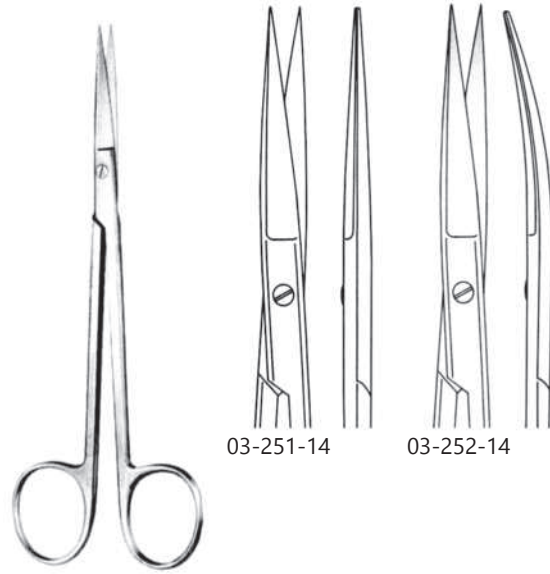

03-251-14

03-252-14

SANVENERO
03-251-14 - 03-252-14
14 cm

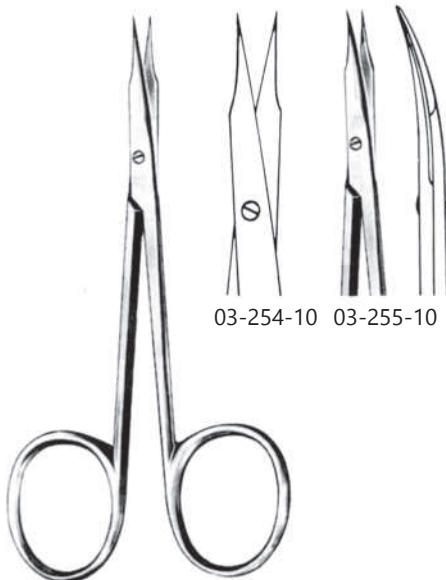

03-254-10

03-255-10

STEVENS
03-254-10 - 03-255-10
10.5 cm
sharp

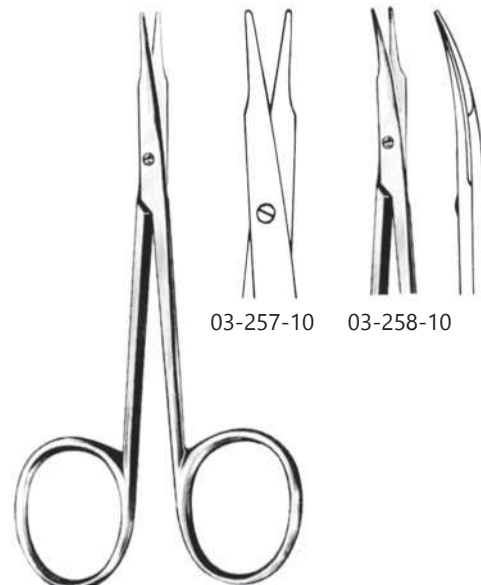

03-257-10

03-258-10

STEVENS
03-257-10 - 03-258-10
10.5 cm
blunt



METZENBAUM-NELSON
 03-260-18 - 03-265-30



03-260-18
 18 cm



03-261-20
 20 cm



03-262-23
 23 cm



03-263-25
 25 cm



03-264-28
 28 cm



03-265-30
 30 cm



METZENBAUM-NELSON
 03-267-18 - 03-272-30



03-267-18
 18 cm



03-268-20
 20 cm



03-269-23
 22 cm



03-270-25
 25 cm



03-271-28
 28 cm



03-272-30
 30 cm



METZENBAUM-NELSON
 03-274-18 - 03-279-30



03-274-18
 18 cm



03-275-20
 20 cm



03-276-23
 23 cm



03-277-25
 25 cm



03-278-28
 28 cm



03-279-30
 30 cm



METZENBAUM-NELSON
 03-281-18 - 03-286-30



03-281-18
 18 cm



03-282-20
 20 cm



03-283-23
 23 cm



03-284-25
 25 cm



03-285-28
 28 cm



03-286-30
 30 cm



METZENBAUM-NELSON
 03-288-18 - 03-293-30



03-288-18
 18 cm



03-289-20
 20 cm



03-290-23
 23 cm



03-291-25
 25 cm



03-292-28
 28 cm



03-293-30
 30 cm



METZENBAUM-NELSON
 03-295-18 - 03-300-30

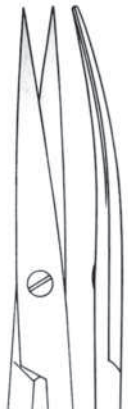

03-295-18
 18 cm



03-296-20
 20 cm



03-297-23
 23 cm



03-298-25
 25 cm



03-299-28
 28 cm



03-300-30
 30 cm



SIMS
03-302-20 - 03-305-23

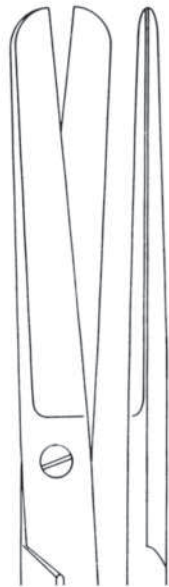

03-302-20
20 cm

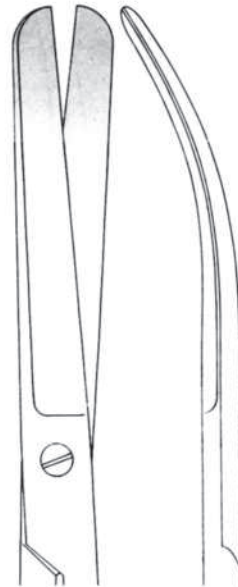

03-303-20
20 cm

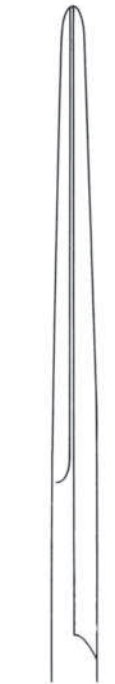

03-304-23
23 cm



03-305-23
23 cm

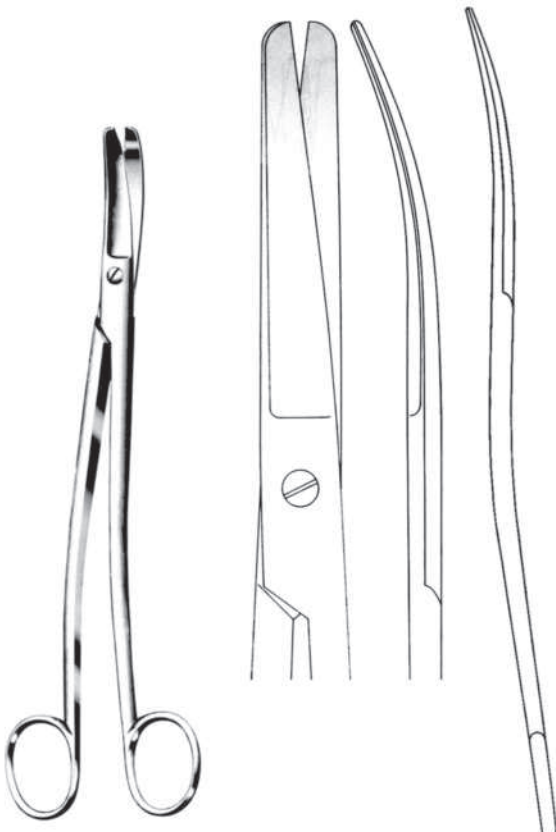

SIEBOLD
03-307-24
24 cm



NERVE
03-309-15 - 03-310-15
15 cm



03-309-15



03-310-15

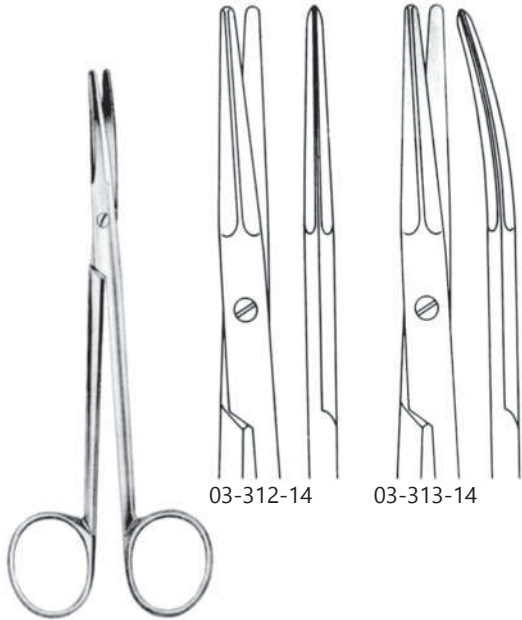

DISSECTING SCISSORS
with outside cutting edge
03-312-14 - 03-313-14
14.5 cm

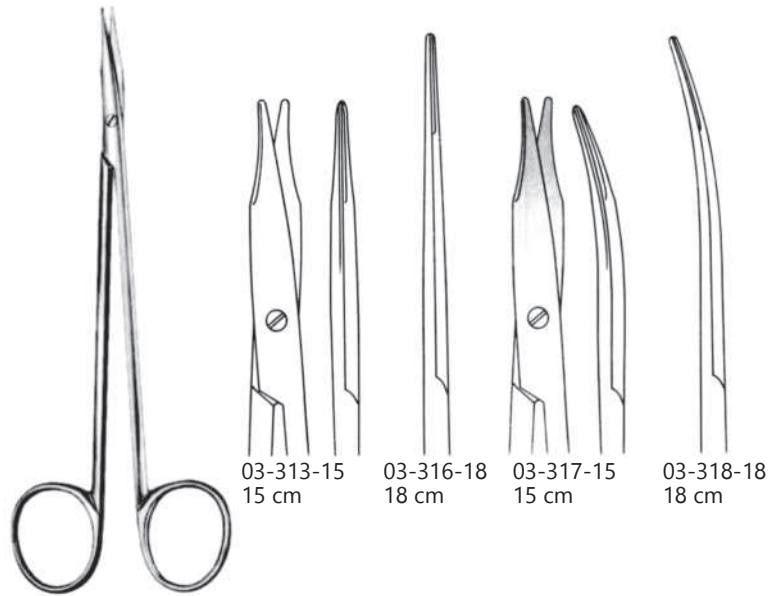

REYNOLDS
03-315-15 - 03-318-18

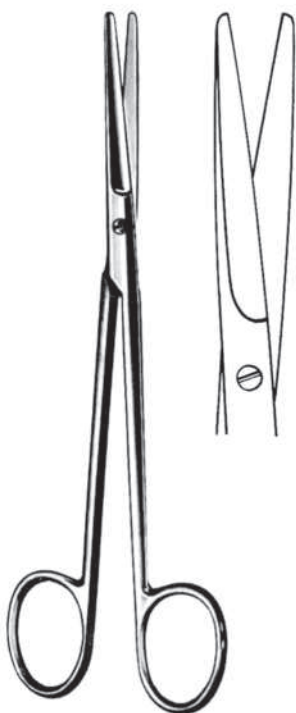

MIXTER
03-320-15
15 cm



MIXTER
03-322-15
15 cm

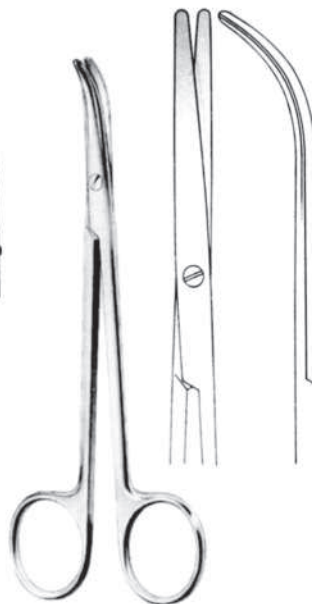

FOMON
03-324-14
13.5 cm

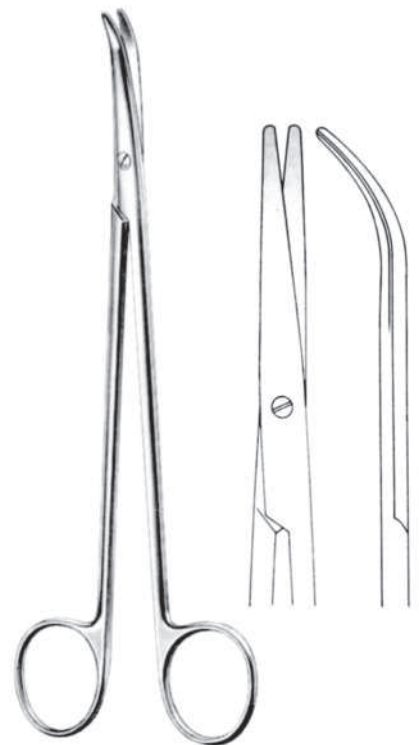

THOREK
03-326-19
19 cm



GOLDMAN FOX
03-328-13
13 cm
1 blade saw edge



GOLDMAN FOX
03-330-13
13 cm
1 blade saw edge



QUINBY
03-332-13
13 cm

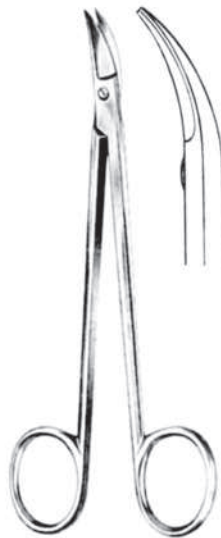

QUINBY
03-334-13
13 cm

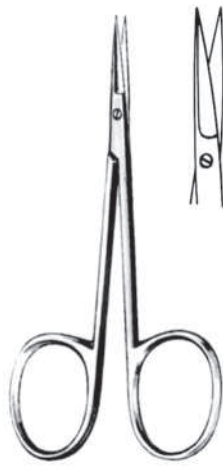
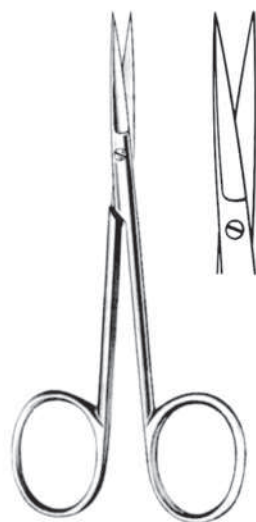

LOCKLIN
03-336-16
16 cm

IRIS-MICRO
03-338-09
09 cmIRIS-MICRO
03-340-09
09 cmIRIS-SELECT
03-342-10
10.5 cmIRIS-SELECT
03-346-10
10.5 cm

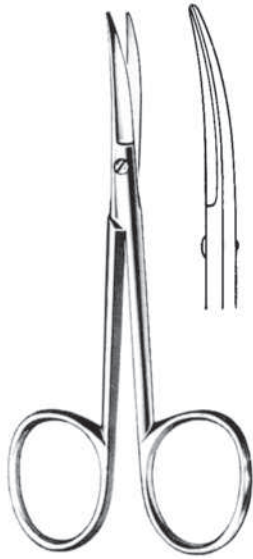

03-348-10
10.5 cm

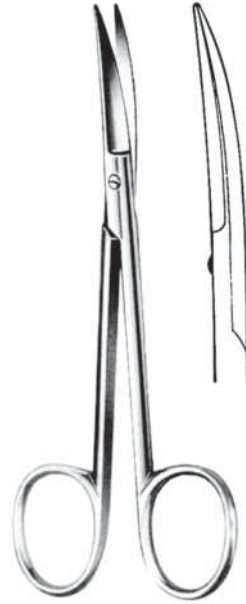

03-350-12
12 cm

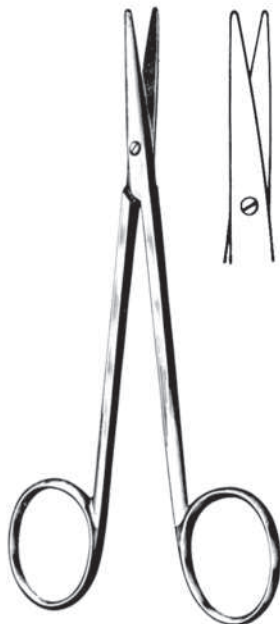

03-352-12
12 cm

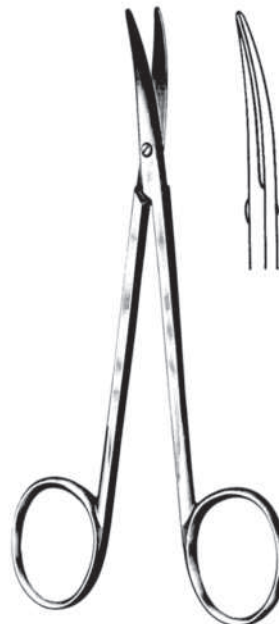

03-354-12
12 cm

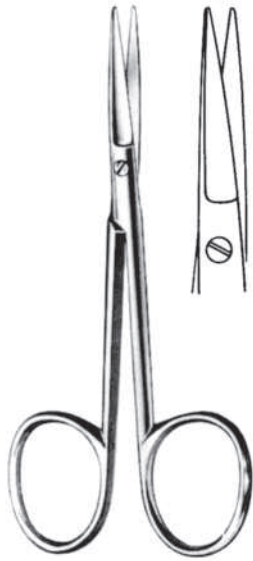

03-356-10
 10.5 cm



03-358-10
 10 cm

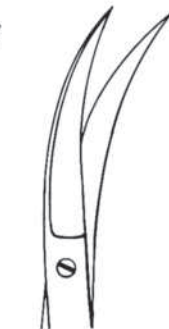

03-360-12
 12 cm

03-358-10 - 03-360-12

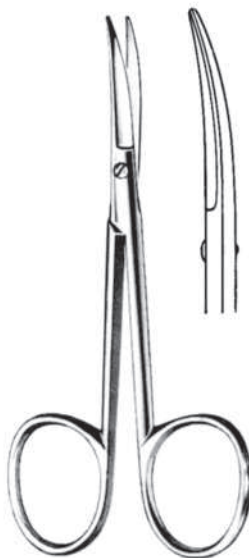

03-362-12
 12 cm

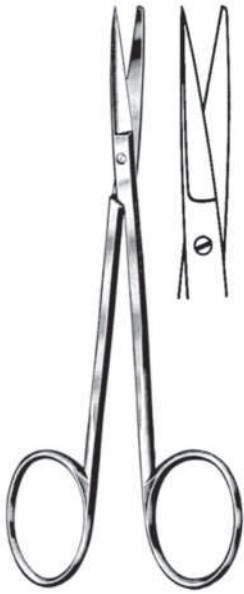

03-364-11
11.5 cm



03-366-11
11.5 cm

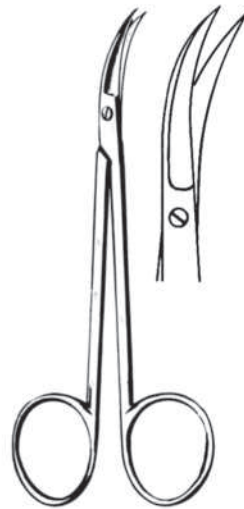

WALKER
03-368-10
10 cm

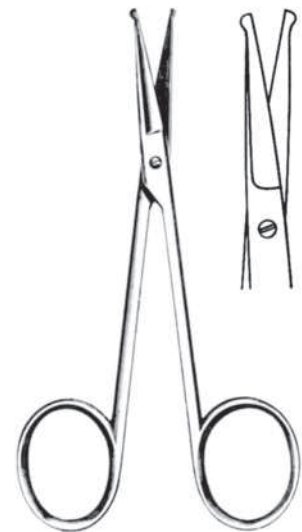

03-370-10
10.5 cm

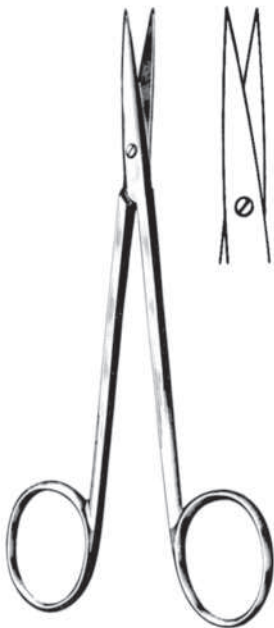

03-372-12
12 cm

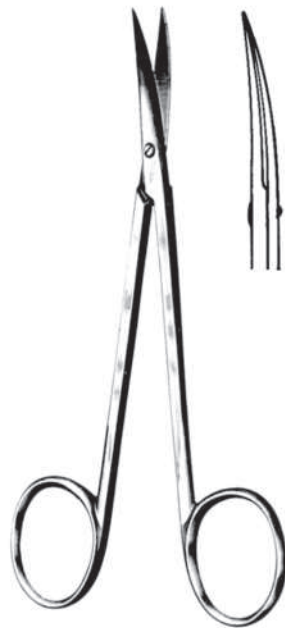

03-374-12
12 cm



GRAEFE
03-376-10
10.5 cm

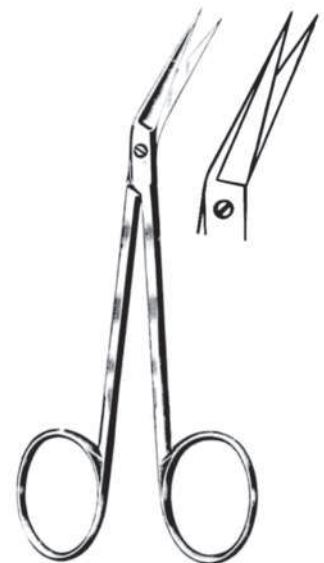

03-378-11
11.5 cm

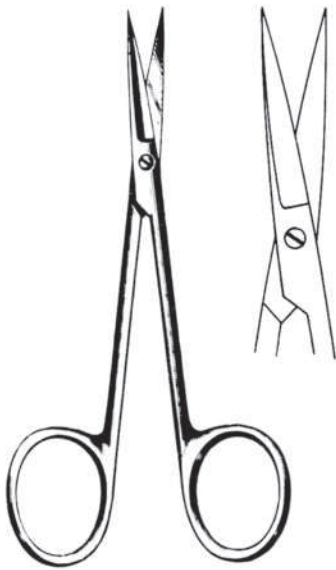

03-380-10
10.5 cm

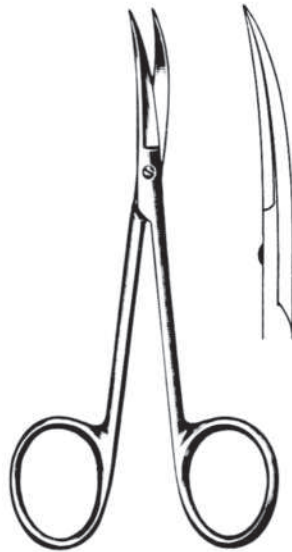

03-382-10
10.5 cm



03-384-09 9 cm
03-385-10 10.5 cm
03-385-11 11.5 cm
03-387-12 12.5 cm



03-389-09 9 cm
03-390-10 10.5 cm
03-391-11 11.5 cm
03-392-12 12.5 cm

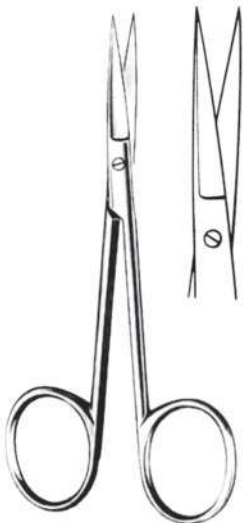

03-394-09 9 cm
03-395-10 10.5 cm

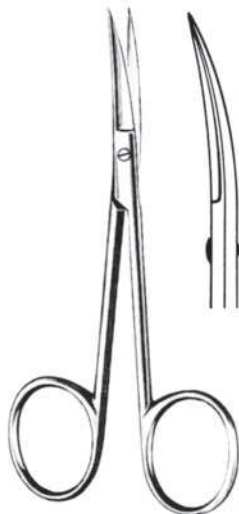

03-397-09 9 cm
03-398-10 10.5 cm

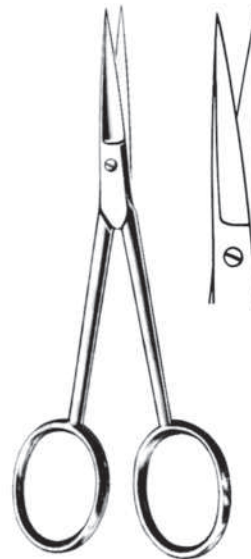

03-400-11
11 cm



03-402-11
11 cm

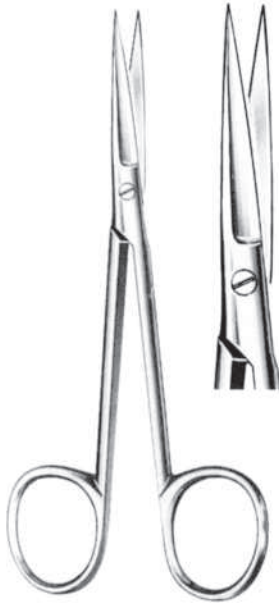

03-404-12
12 cm

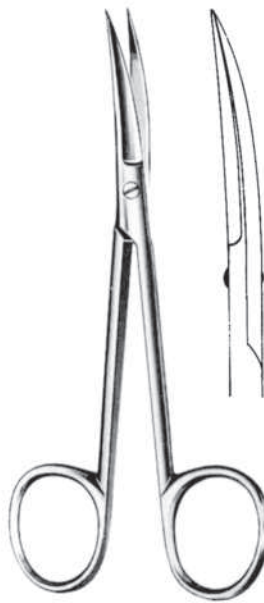

03-406-12
12 cm

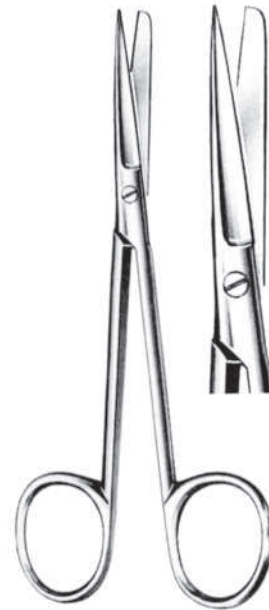

03-408-12
12 cm



WAGNER
03-410-12
12 cm

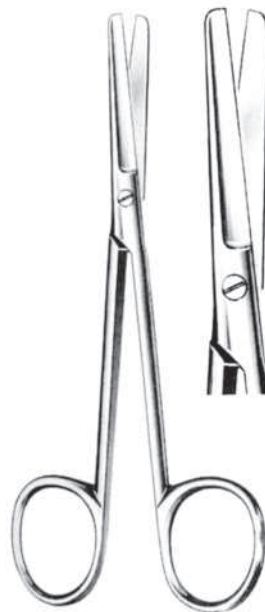

WAGNER
03-412-12
12 cm



WAGNER
03-414-12
12 cm



03-416-14



03-417-14

JOSEPH
 03-416-14 - 03-417-14
 14 cm



03-419-12
 12 cm



03-420-15
 15 cm

KLINER
 03-419-12 - 03-420-15



REYNOLDS (JAMESSON)
 03-422-12 12 cm sharp
 03-423-14 14 cm sharp



REYNOLDS (JAMESSON)
 03-425-12 12 cm blunt
 03-426-14 14 cm blunt

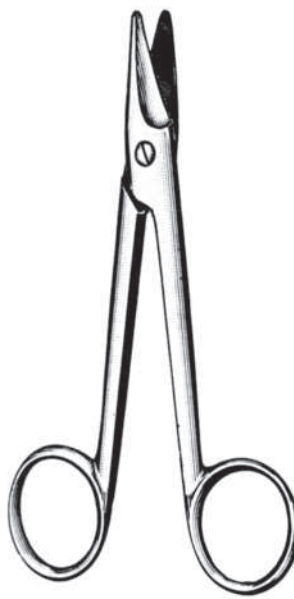

SISTRUNK
 03-428-14
 14 cm

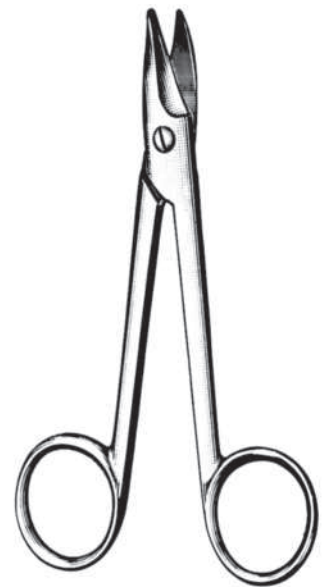

SISTRUNK (curved)
 03-430-14
 14 cm



DE MARTEL
 03-423-18
 18 cm
 blunt



DE MARTEL
 03-434-18
 18 cm
 blunt



DE MARTEL
 03-436-18
 18 cm
 sharp



DE MARTEL
 03-438-18
 18 cm
 sharp



03-440-13 13 cm
 03-441-14 14.5 cm



03-443-13 13 cm
 03-444-14 14.5 cm



03-446-13 13 cm
 03-447-14 14.5 cm



03-449-13 13 cm
 03-450-14 14.5 cm

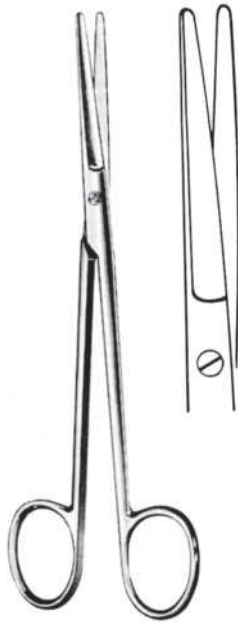

WERTHEIM
 03-452-14
 14.5 cm



WERTHEIM
 03-455-14
 14.5 cm



WERTHEIM
 03-456-20 20 cm
 03-457-23 23 cm



KNAPP
 03-459-12
 12 cm
 sharp

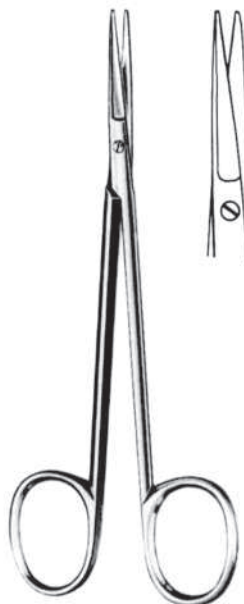

KNAPP
 03-461-12
 12 cm
 blunt



KNAPP
 03-463-12
 12 cm
 sharp



KNAPP
 03-465-12
 12 cm
 blunt

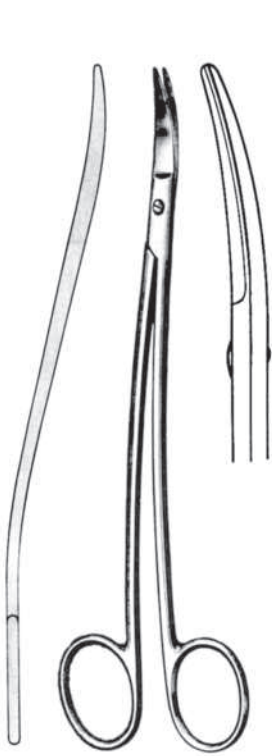

SATINSKY
 03-467-18
 18 cm



KLINKENBERGH
 03-469-23
 23 cm



HOUSE-TOENNIS
 03-471-18
 23 cm

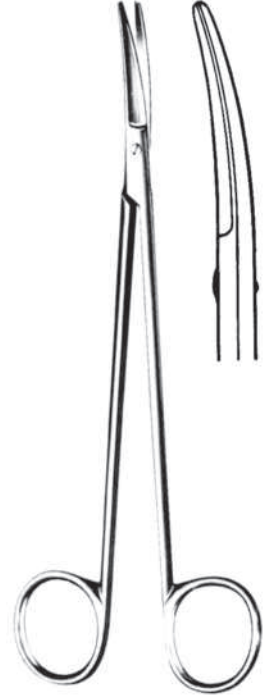

TOENNIS
 03-473-18
 18 cm



RICHTER
 03-475-14
 14 cm

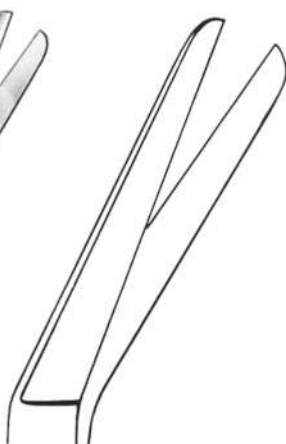

FERGUSON
 03-477-16
 16.5 cm

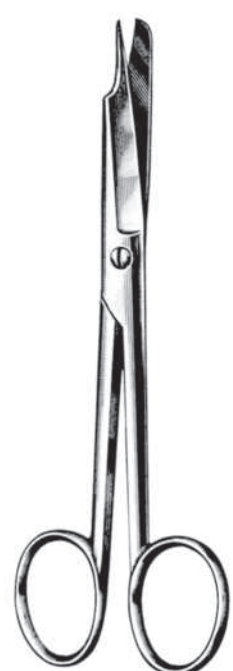

NAIL SPLITTING
 03-479-13 13 cm
 03-480-15 15 cm

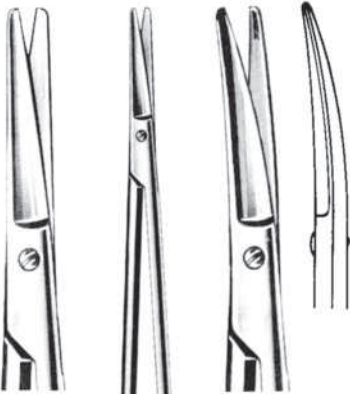

03-482-26

03-483-26



CHURCH
 03-482-16 - 03-483-26
 25.5 cm

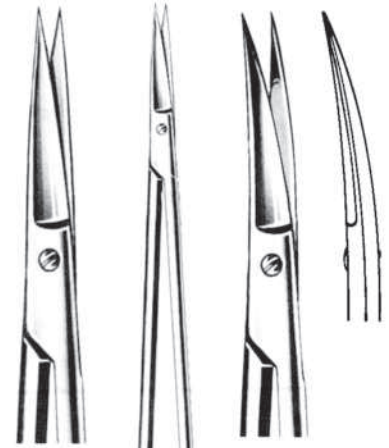

03-485-26

03-486-26

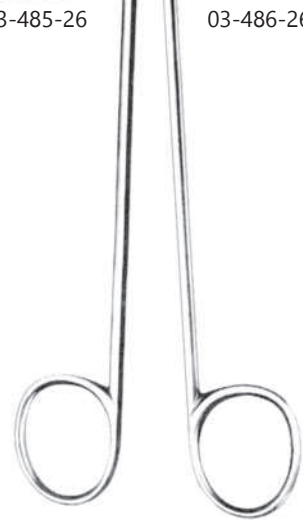

DUFFIELD
 03-485-26 - 03-486-26
 25.5 cm

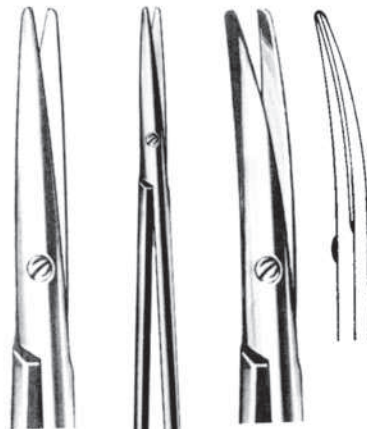

03-488-26

03-489-26



LINCOLN
 03-488-26 - 03-489-26
 25.5 cm

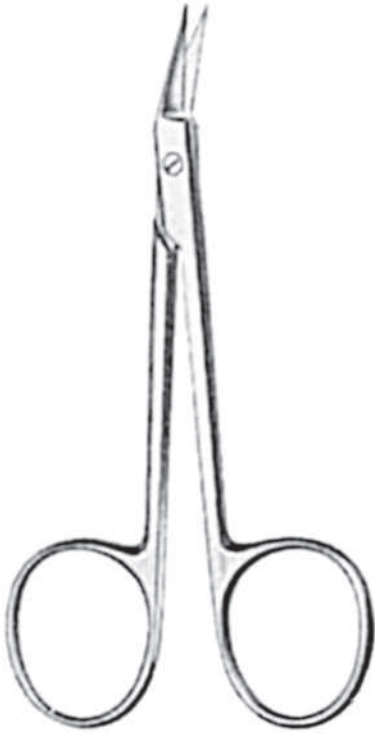

O' BRIEN
03-491-16
9.5 cm

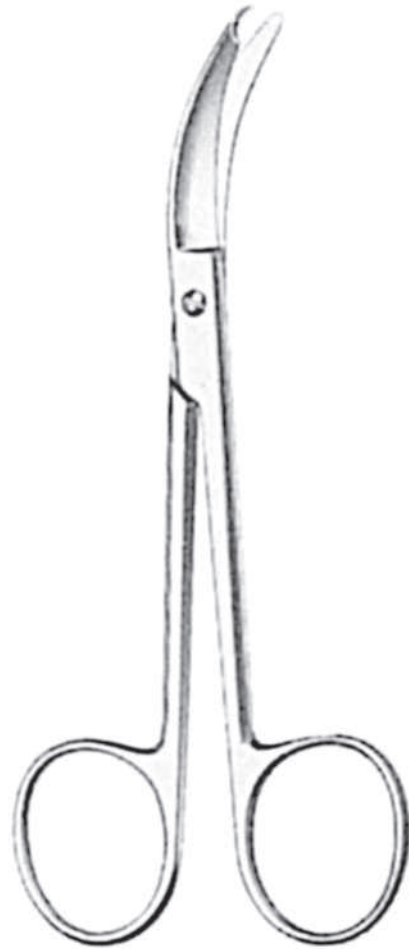

NORTHBENT
03-493-12
12.5 cm

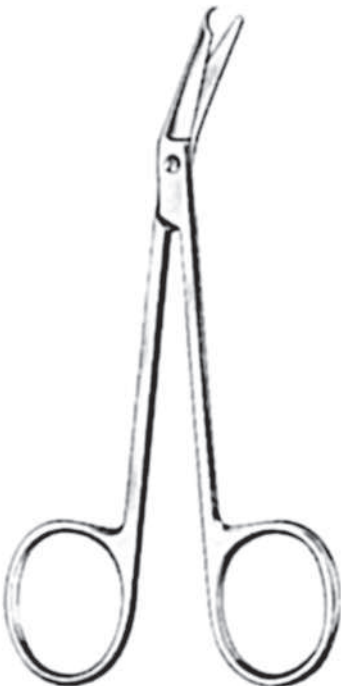

SHORTBENT
03-495-09
9 cm



SPENCER
03-497-09 9cm
03-498-10 10.5cm
03-499-13 13cm

03-501-11
11.5 cmSPENCER-DELICATE
03-503-11
11.0 cmBUCK
03-505-14 14.5 cm
03-506-18 18.0 cmLITTAUER
03-508-14
14.0 cm

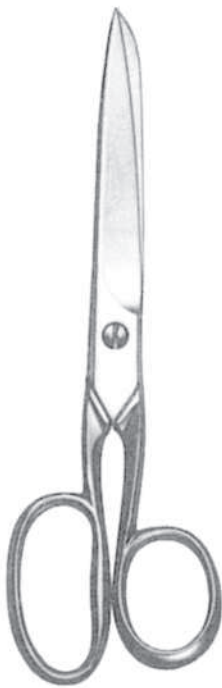

SMITH
03-510-18
18 cm

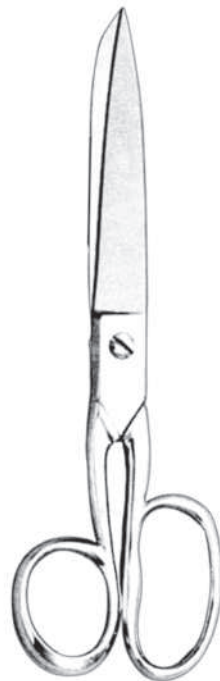

SMITH
03-512-18
18 cm

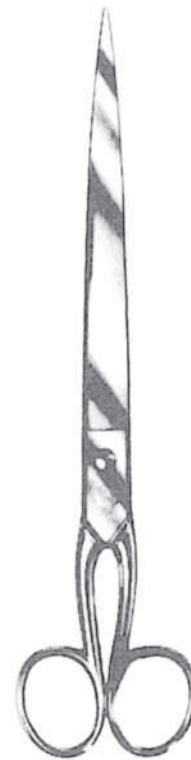

PAPER
03-514-20 20 cm
03-515-25 25 cm



03-517-13 (13 cm)
03-518-16 (16 cm)

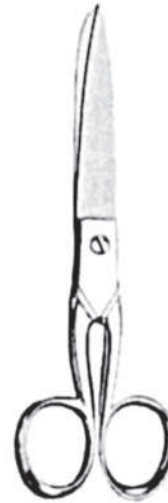

03-520-13
13 cm



SCHOOL
03-522-11
11 cm



SCHOOL
03-524-12
12 cm

TC GOLD



03-526-14
14.5 cm



03-528-14
14.5 cm



03-530-14
14.5 cm



03-532-14
14.5 cm



03-534-14
14.5 cm



03-536-14
14.5 cm

TC GOLD



MAYO-HARRINGTON
 03-538-20 20 cm
 03-539-23 23 cm



MAYO
 03-541-14 14 cm
 03-542-17 17 cm



MAYO
 03-544-14 14 cm
 03-545-17 17 cm



MAYO-HARRINGTON
 03-547-20 20 cm
 03-548-23 23 cm



SIMS
 03-550-20 20 cm
 03-551-23 23 cm

TC GOLD



METZENBAUM
 03-553-18 - 03-558-30



03-553-18
 18 cm



03-554-20
 20 cm



03-555-23
 23 cm



03-556-25
 25 cm



03-557-28
 28 cm



03-558-30
 30 cm



METZENBAUM
 03-560-18 - 03-565-30



03-560-18
 18 cm



03-561-20
 20 cm



03-562-23
 23 cm



03-563-25
 25 cm



03-564-28
 28 cm

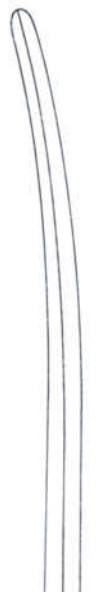

03-565-30
 30 cm

TC GOLD



METZENBAUM FINO
 03-567-23 - 03-570-14

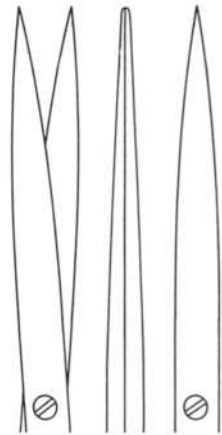

03-567-23
 23 cm



03-568-20
 20 cm



03-569-18
 18 cm



03-570-14
 14 cm



METZENBAUM FINO
 03-572-23 - 03-575-14

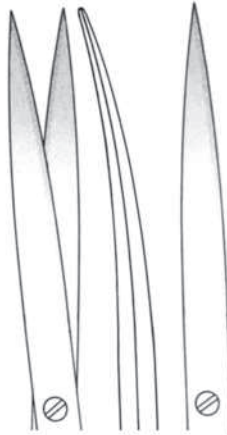

03-572-23
 23 cm



03-573-20
 20 cm



03-574-18
 18 cm



03-575-14
 14 cm

TC GOLD



METZENBAUM
 03-577-20 - 03-578-23

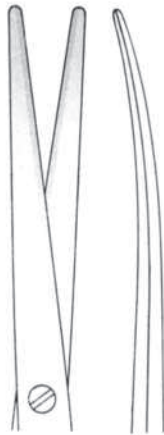

03-567-20
 20 cm



03-568-23
 23 cm



METZENBAUM-LAHEY
 03-580-14
 14 cm



TOENNIS-ADSON
 03-582-17
 17 cm



LOCKLIN
 03-584-16
 16 cm

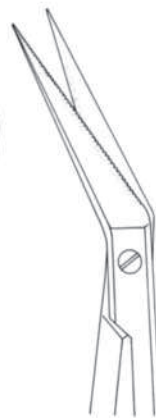

LOCKLIN
 03-586-16
 16 cm

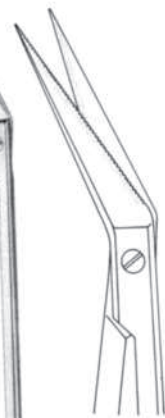

TC GOLD

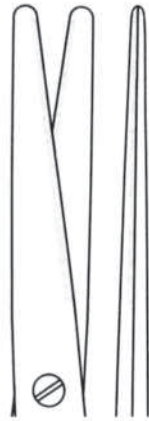

03-588-16
16 cm



03-589-21
21 cm



03-591-16
16 cm



03-592-21
21 cm

LEXER
03-588-16 - 03-589-21

LEXER
03-591-16 - 03-592-21



03-594-23
23 cm



03-595-22
22.5 cm

PARAMETRIUM
03-594-23 - 03-595-22

TC GOLD



KELLY
 05-597-16 - 05-598-16
 16 cm

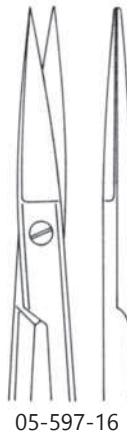

GOLDMAN FOX
 05-600-13
 13 cm



GOLDMAN FOX
 05-602-13
 13 cm

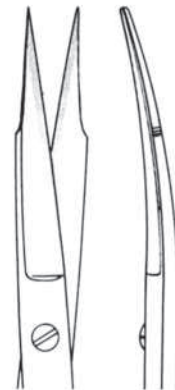

TC GOLD

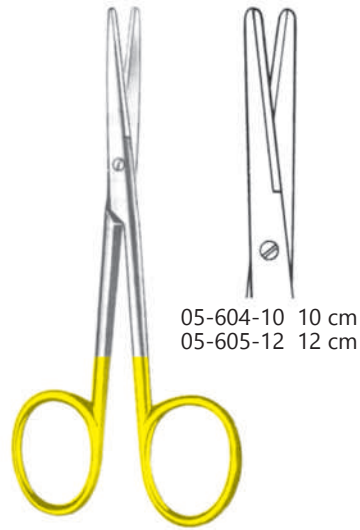

05-604-10 10 cm
 05-605-12 12 cm

LEXER-BABY
 05-604-10 - 05-605-12

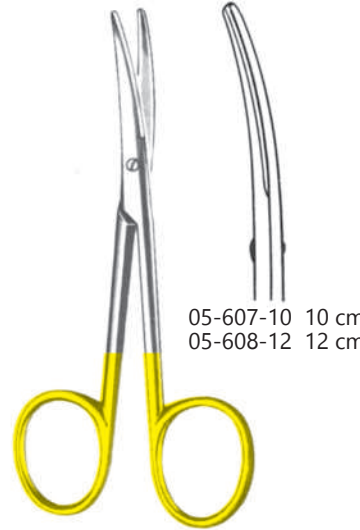

05-607-10 10 cm
 05-608-12 12 cm

LEXER-BABY
 05-607-10 - 05-608-12

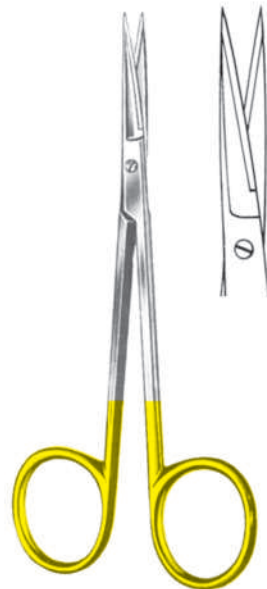

IRIS
 05-610-11
 11.5 cm



IRIS
 05-612-11
 11.5 cm



STILE SUPER CUT
 05-614-10 straight sharp 10 cm
 05-615-10 curved sharp 10 cm



JABALEY-STILLE SUPER CUT
 05-617-12 straight sharp 12 cm
 05-618-12 curved sharp 12 cm



STEVENS SUPER CUT
 05-620-12 straight sharp 12.5 cm
 05-621-12 curved sharp 12.5 cm



LISTER (BANDAGE)
 05-623-14
 14 cm



MAYO-STILE SUPER CUT
03-625-15 straight 15 cm
03-626-15 curved 15 cm



STILE-MAYO SUPER CUT
03-628-15 straight 15 cm
03-629-17 straight 17 cm
03-630-15 curved 15 cm
03-631-17 curved 17 cm



MAYO-HARRINGTON CUT
03-633-20 straight 20 cm
03-634-23 straight 23 cm



STILE-RANGELL SUPER CUT
03-636-12 curved 12.5 cm
03-637-15 curved 15 cm
03-638-18 curved 18 cm
03-639-20 curved 20 cm
03-640-23 curved 23 cm



METZENBAUM SUPER CUT
 03-642-15 straight 15 cm
 03-643-18 straight 18 cm
 03-644-20 straight 20 cm
 03-645-23 straight 23 cm
 03-646-26 straight 26 cm



METZENBAUM SUPER CUT
 03-648-15 curved 15 cm
 03-649-18 curved 18 cm
 03-650-20 curved 20 cm
 03-651-23 curved 23 cm
 03-652-26 curved 26 cm



METZENBAUM SUPER CUT
 03-654-12 straight 12.5 cm
 03-655-12 curved 12.5 cm





IRIS WITHOUT TC
03-657-11 STRAIGHT
03-658-11 STRAIGHT
11.5 cm



IRIS WITH TC
03-660-11 STRAIGHT
03-661-11 CURVED
11.5 cm



LA GRANGE WITHOUT TC
03-663-11
11.5 cm



LA GRANGE WITH TC
03-665-11
11.5 cm



04

Artery Forceps
Arterienklemme
Pinzas Arteriales

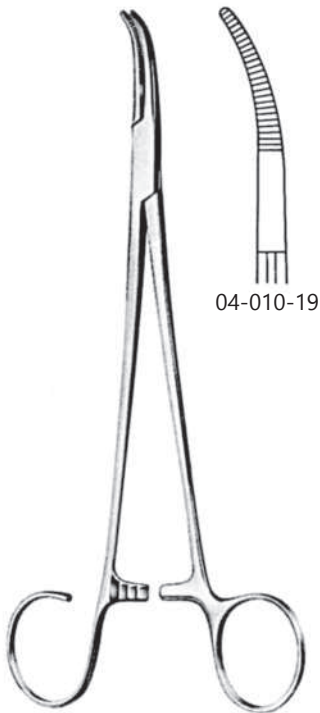

04-010-19

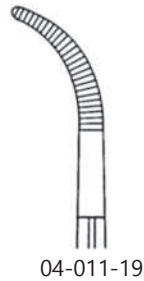

04-011-19

SCHNIFT-SAWTELL
 04-010-19 - 04-011-19
 19 cm

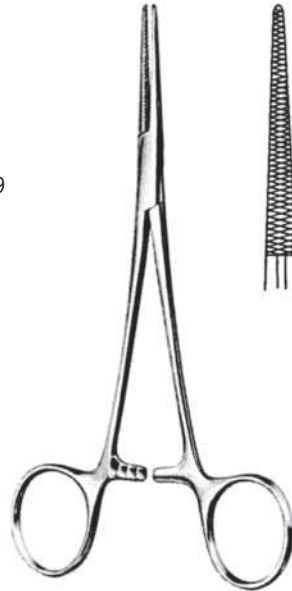

DIXON-LOVELACE
 04-013-15
 15.5 cm



DIXON-LOVELACE
 04-015-15
 15.5 cm



SCHNIDT-SAWELL
 01-018-20 - 04-018-19
 19 cm

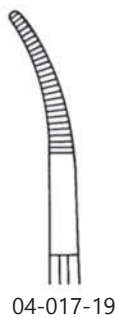

04-017-19

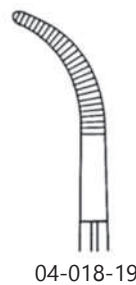

04-018-19

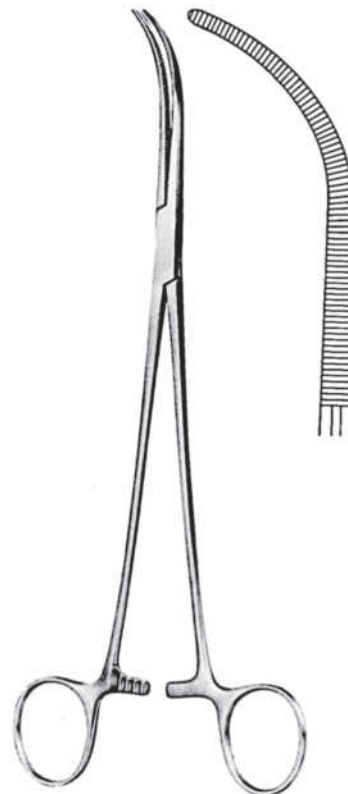

OVERHOLT-MIXTER
 04-020-21
 21 cm

SP



DANDY
 04-022-14
 14 cm



DANDY
 04-024-14
 14 cm



CRAFOORD-SELLORS
 04-026-22 - 04-028-24
 22 cm

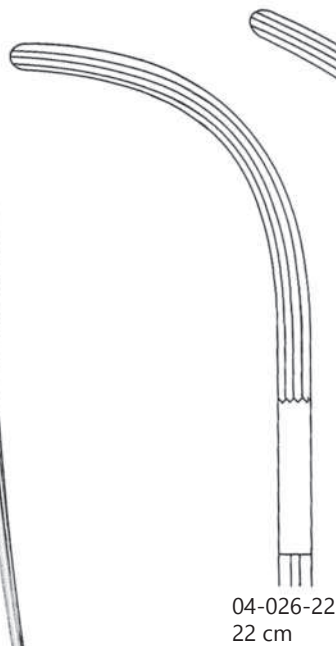

04-026-22
 22 cm

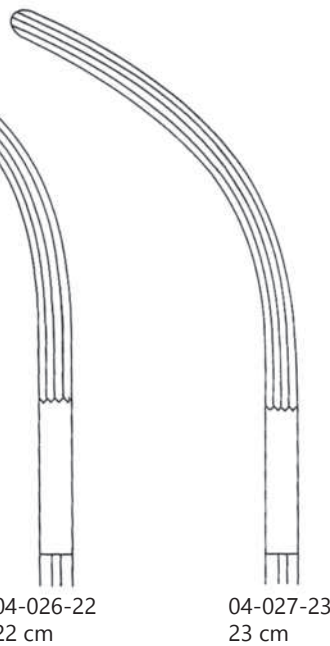

04-027-23
 23 cm



04-028-24
 24 cm



04-030-20 20 cm
 04-031-26 26 cm

BENGOLEA
 04-030-20 - 04-033-26



04-032-20 20 cm
 04-033-26 26 cm

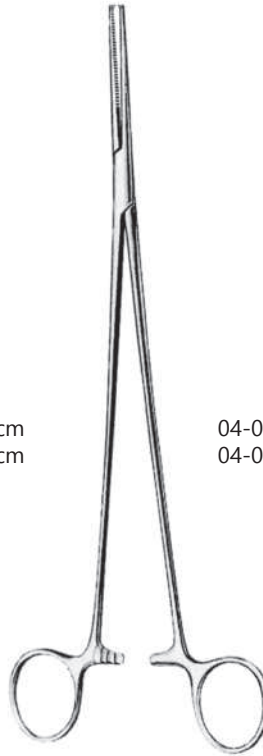

04-035-20 20 cm
 04-036-26 26 cm

BENGOLEA
 04-035-20 - 04-038-26

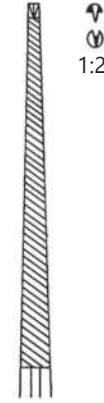

1:2



1:2

04-037-20 20 cm
 04-038-26 26 cm

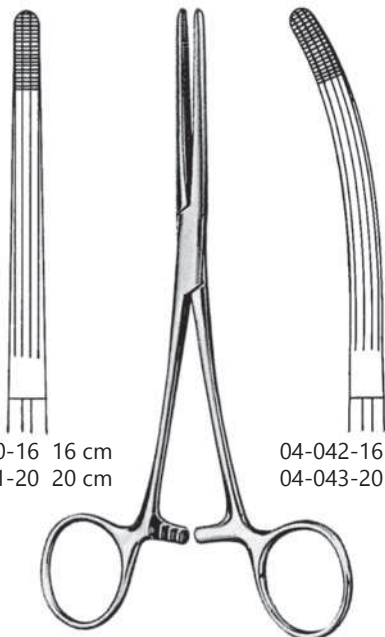

04-040-16 16 cm
 04-041-20 20 cm

04-042-16 16 cm
 04-043-20 20 cm

ROCHESTER-CARMALT
 04-040-16 - 04-043-20

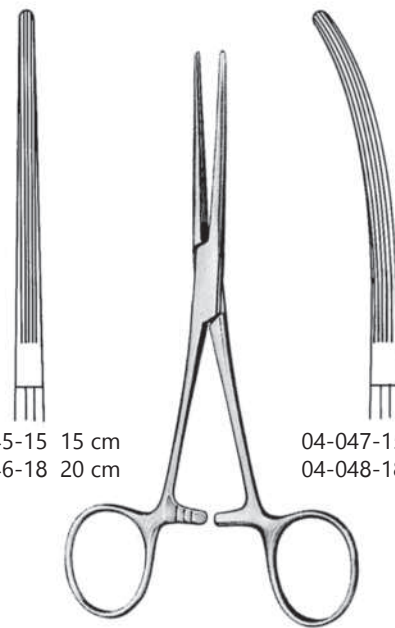

04-045-15 15 cm
 04-046-18 20 cm

04-047-15 15 cm
 04-048-18 18.5 cm

BAINBRIDGE
 04-045-15 - 04-048-18



04-050-22



04-051-22



ROBERTS
 04-050-22 - 04-051-22
 22 cm



04-053-24



04-054-24

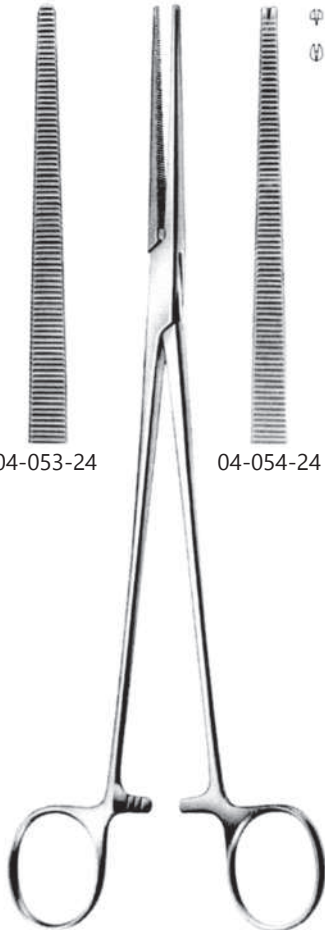

SAROT
 04-053-24 - 04-054-24
 24 cm



CRAFOORD
 04-056-24
 24 cm

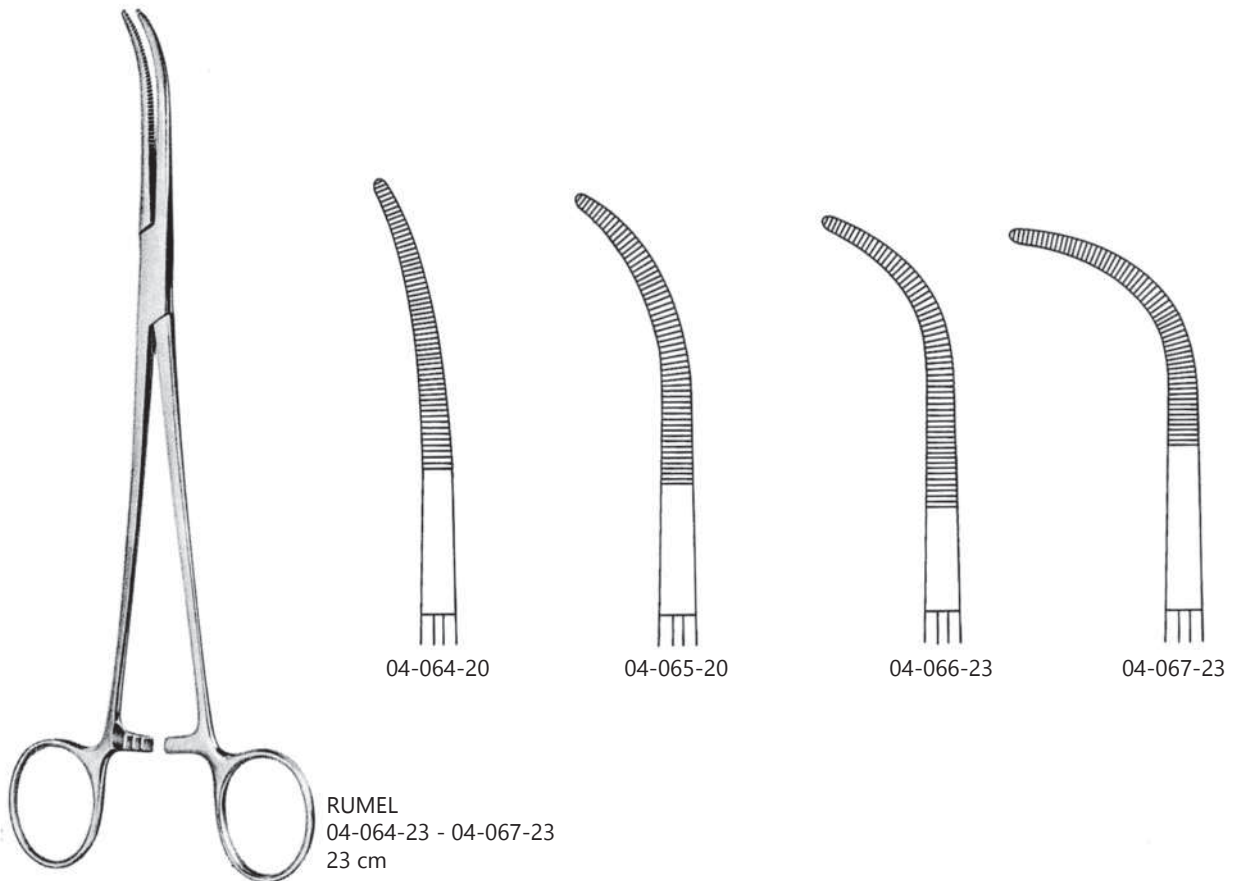
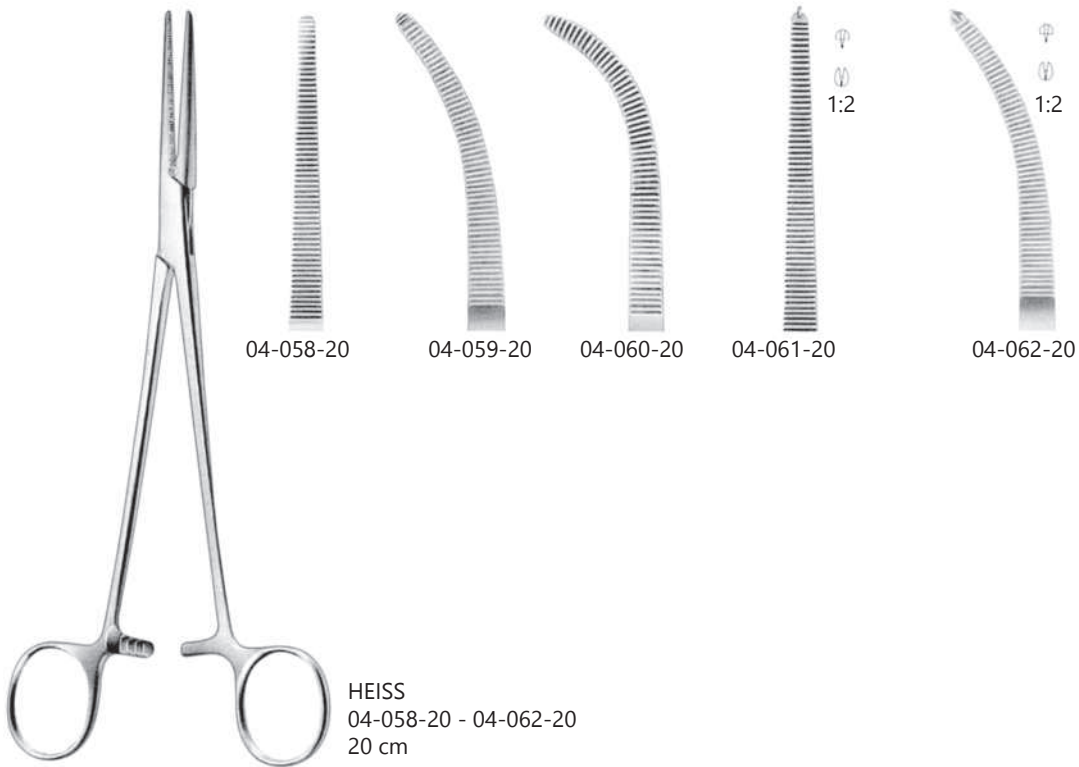

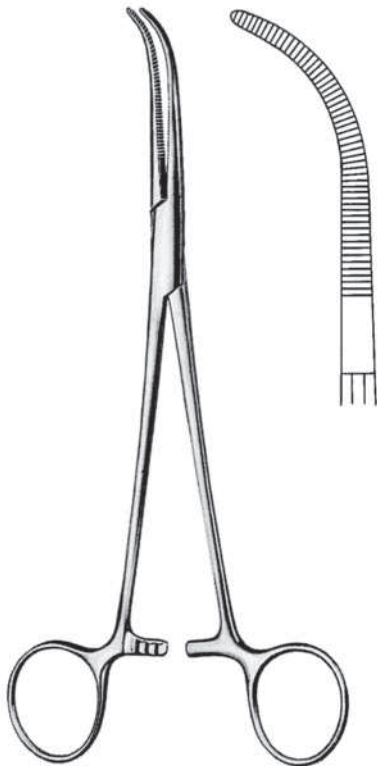

JOHNS HOPKINS
04-069-20
20 cm



ZENKER
04-071-20 - 04-072-29
29.5 cm

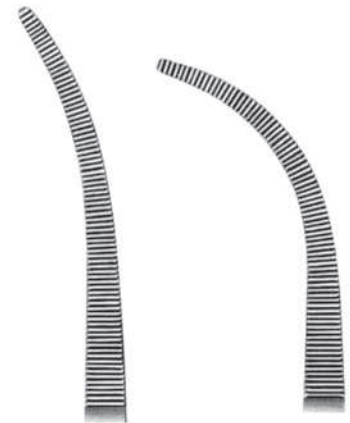

04-071-29

04-072-29



DVERHOLT-GEISSENDOERFER
 04-074-21 - 04-087-27

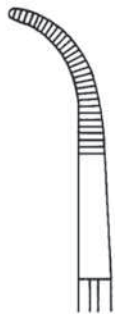

04-074-21 21 cm
 04-075-27 27 cm



04-076-21 21 cm
 04-077-27 27 cm

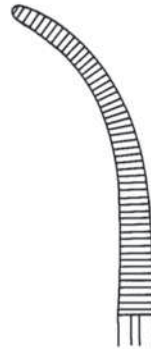

04-078-21 21 cm
 04-079-27 27 cm

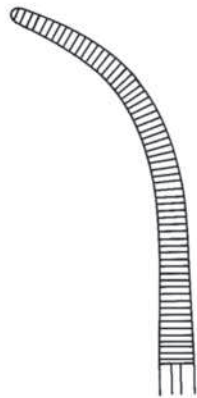

04-080-21 21 cm
 04-081-27 27 cm

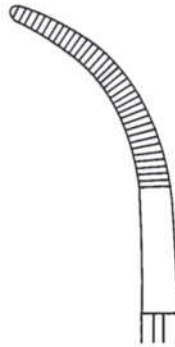

04-082-21 21 cm
 04-083-27 27 cm

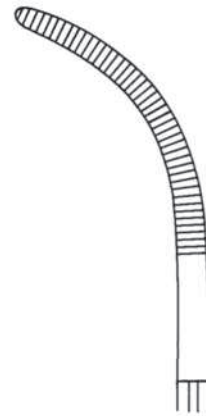

04-084-21 21 cm
 04-085-27 27 cm



04-086-21 21 cm
 04-087-27 27 cm

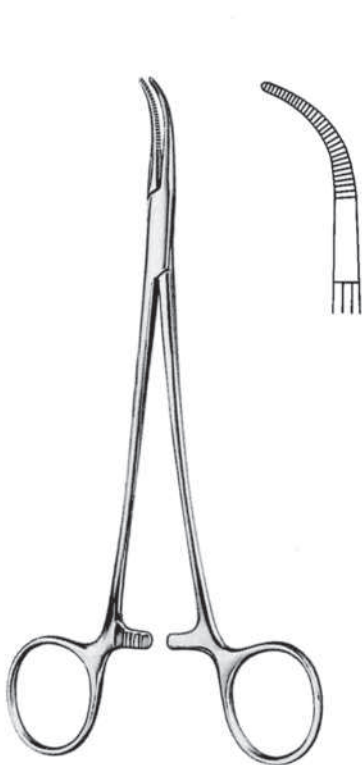

DVERHOLT
 04-089-18
 18.5 cm



DVERHOLT
 04-091-20
 20.5 cm



DVERHOLT
 04-093-21
 21 cm



DVERHOLT
 04-095-21
 21 cm



S-shaped



04-097-18
18 cm

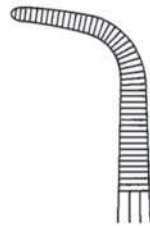

04-098-28
28 cm

MEEKER
04-097-18 - 04-098-28



04-100-18

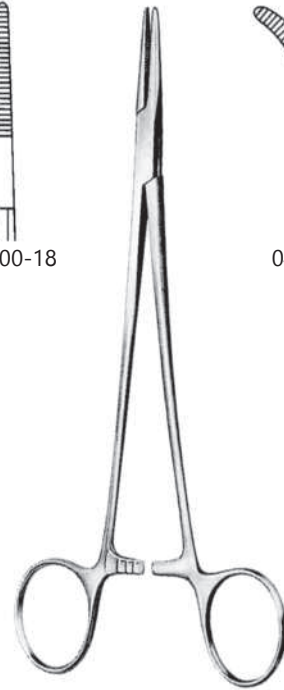

04-101-18

ADSON
04-100-18 - 04-101-18
18.5 cm



04-103-18

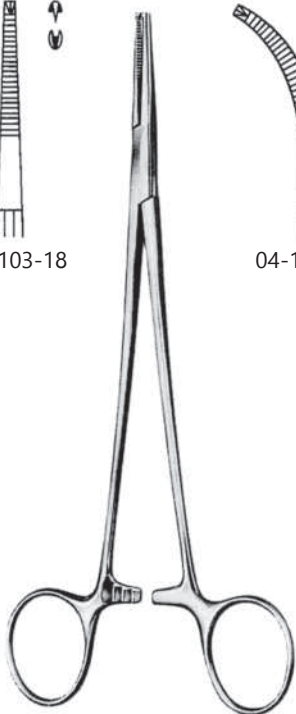

ADSON
04-103-18 - 04-104-18
18.5 cm



04-104-18



BABY-ADSON
04-106-14
14 cm



BABY-ADSON
04-108-18
18 cm



CHAPUT
 04-110-13
 13 cm

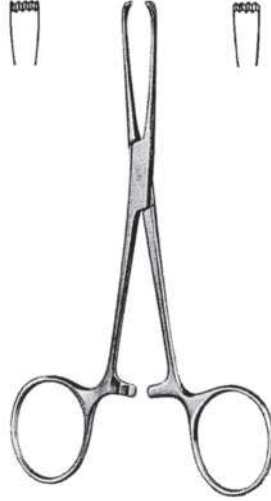

TUFFIER
 04-112-13
 13 cm



04-114-15 15.5 cm
 04-115-20 20 cm

PENNINGTON
 04-114-15 - 04-115-20



MARTEL
 04-117-14
 14 cm



WILLET-MARTEL
 04-119-19
 19 cm



SPENCER-WELLS
04-121-13 - 04-129-20



04-121-13
13 cm



04-122-14
14 cm



04-123-15
15.5 cm



04-124-18
18 cm



04-125-13
13 cm



04-126-14
14 cm



04-127-15
15.5 cm



04-128-18
18 cm



04-129-20
20 cm

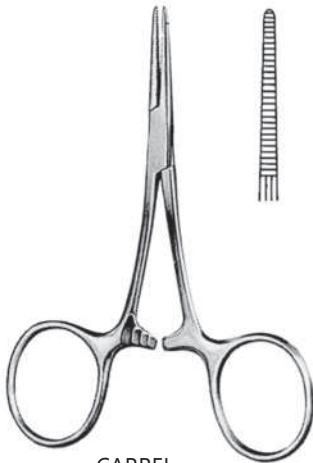

CARREL
04-131-08
8.5 cm

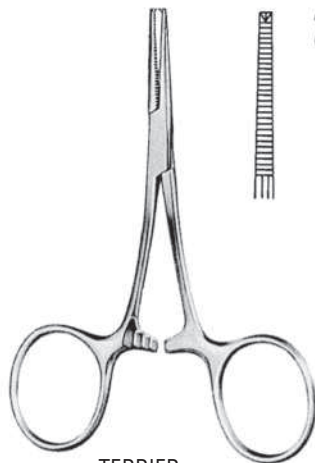

TERRIER
04-133-08
8.5 cm



BABY-MOSQUITO
04-135-10 - 04-138-10
10 cm



04-135-10



04-136-10



04-137-10



04-138-10



MIXTER
 04-140-22 - 04-142-28

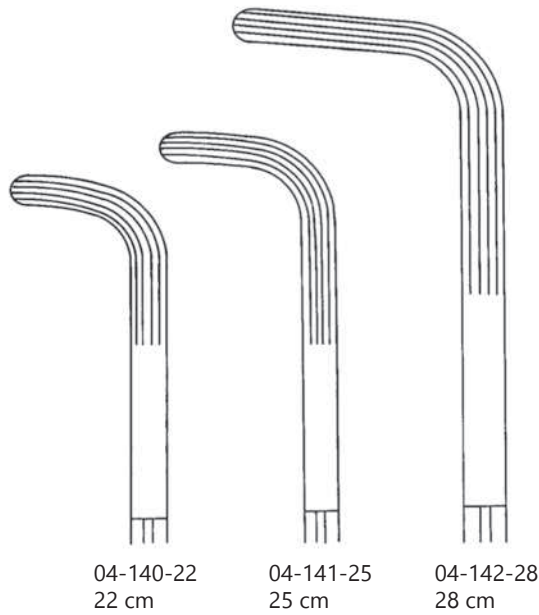

04-140-22
 22 cm

04-141-25
 25 cm

04-142-28
 28 cm

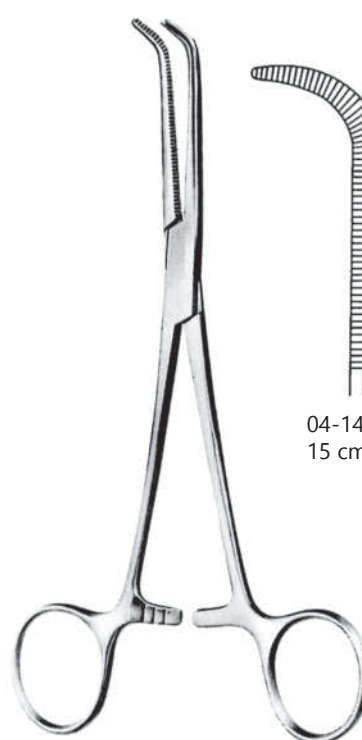

MIXTER
 04-144-15 - 04-145-19

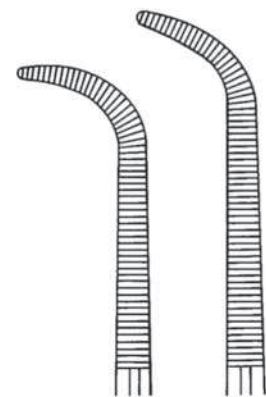

04-144-15
 15 cm

04-145-19
 19 cm

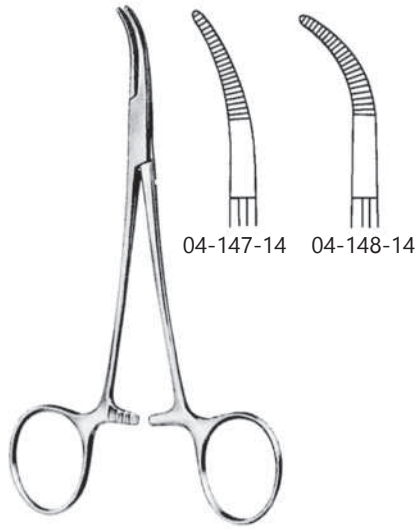

BABY-MIXTER
04-147-17 - 04-148-14
14 cm



BABY-MIXTER
04-150-18
18 cm

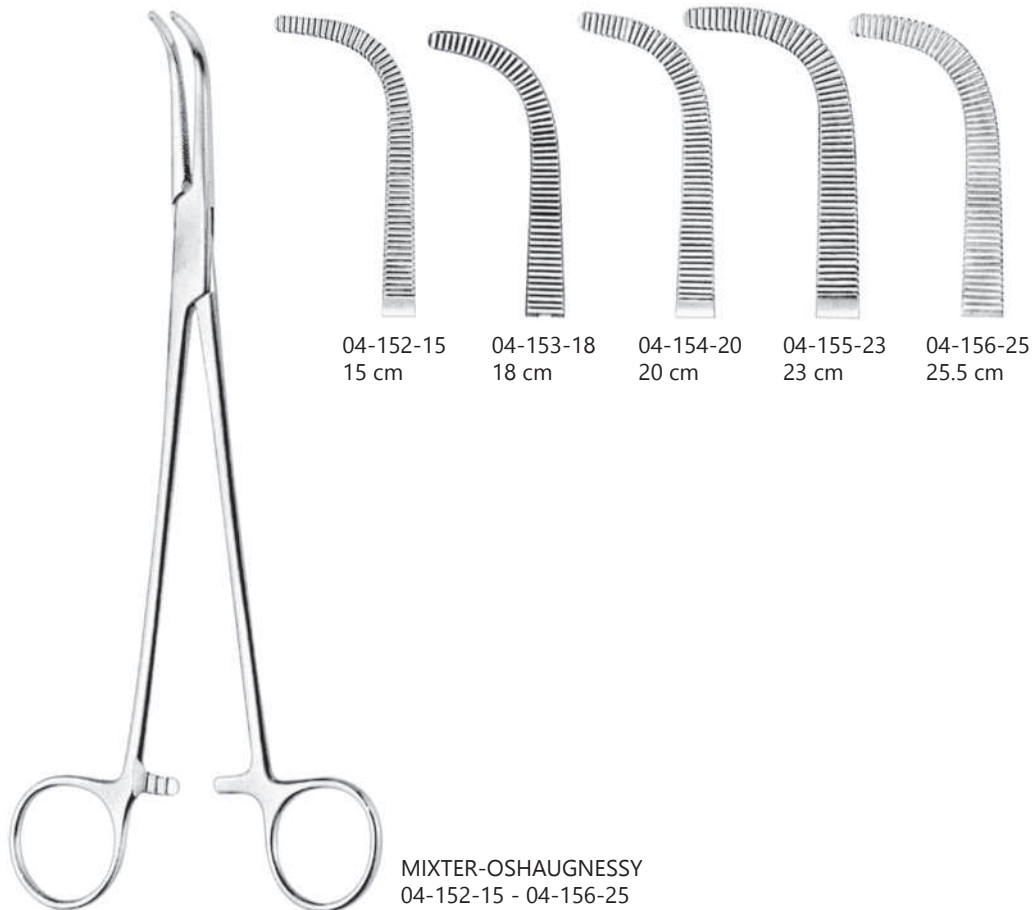

MIXTER-OSHAUGNESSY
04-152-15 - 04-156-25

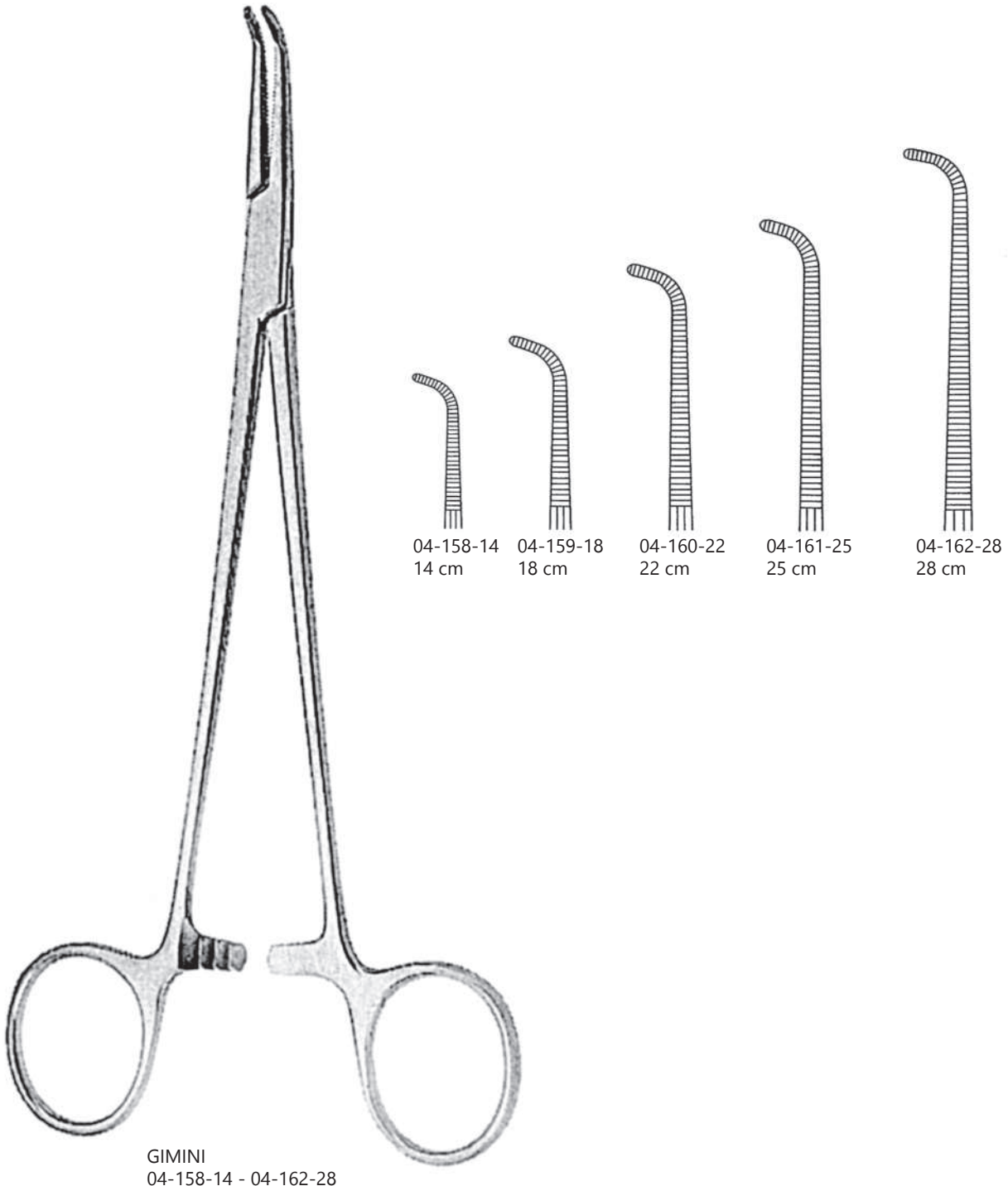



TOENNIS
04-164-21 - 04-167-26



1:2

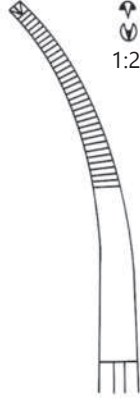

1:2

04-164-21 21 cm 04-166-21 21 cm
04-165-26 26 cm 04-167-26 26 cm



TOENNIS
04-169-21 - 04-172-26



04-169-21 21 cm 04-171-21 21 cm
04-170-26 26 cm 04-172-26 26 cm



KROENLEIN
 04-174-13
 13 cm

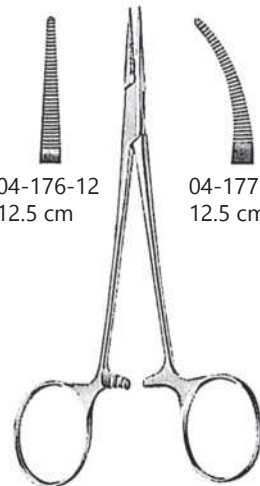

04-176-12
 12.5 cm

04-177-12
 12.5 cm

MICRO-HALSTED
 04-176-12 - 04-177-12

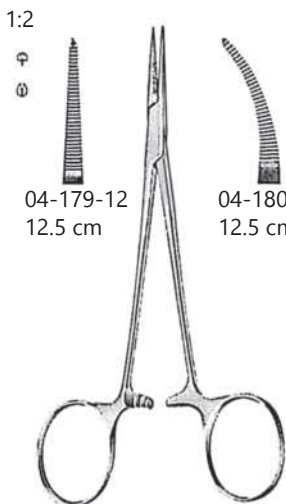

04-179-12
 12.5 cm

04-180-12
 12.5 cm

MICRO-MOSQUITO
 04-179-12 - 04-180-12

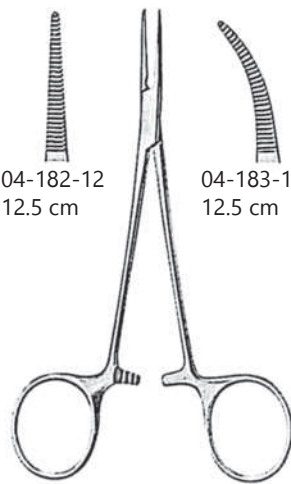

04-182-12
 12.5 cm

04-183-12
 12.5 cm

MICRO-MOSQUITO
 04-182-12 - 04-183-12

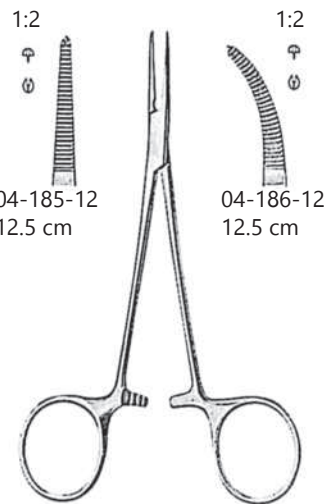

04-185-12
 12.5 cm

04-186-12
 12.5 cm

MICRO-MOSQUITO
 04-185-10 - 04-186-12

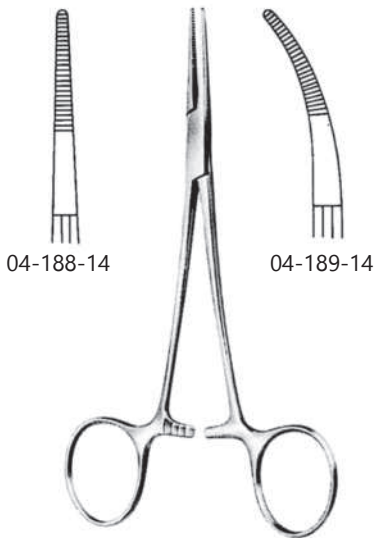

PROVIDENCE-HOSPITAL
04-188-14 - 04-189-14
14 cm



LERICHE
04-191-15 - 04-194-15
15 cm

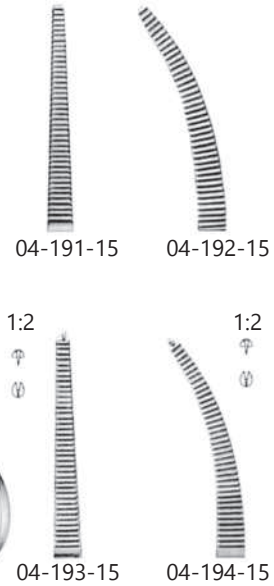

CHRISTOPHE
04-196-15
15 cm

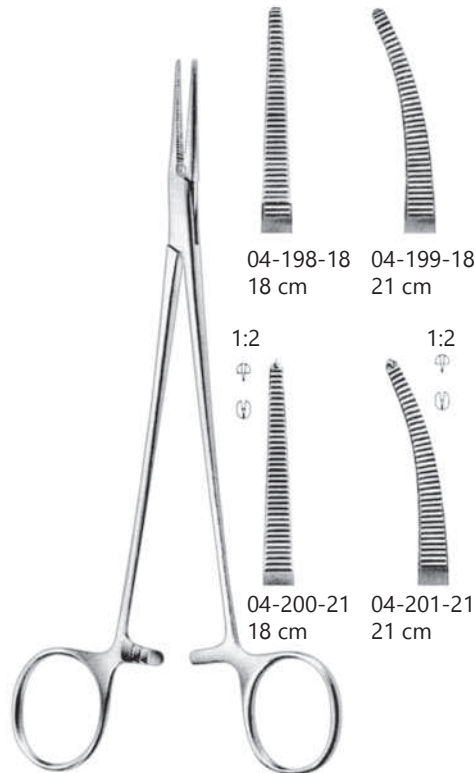

HALSTED-MOSQUITO
04-198-18 - 04-201-21

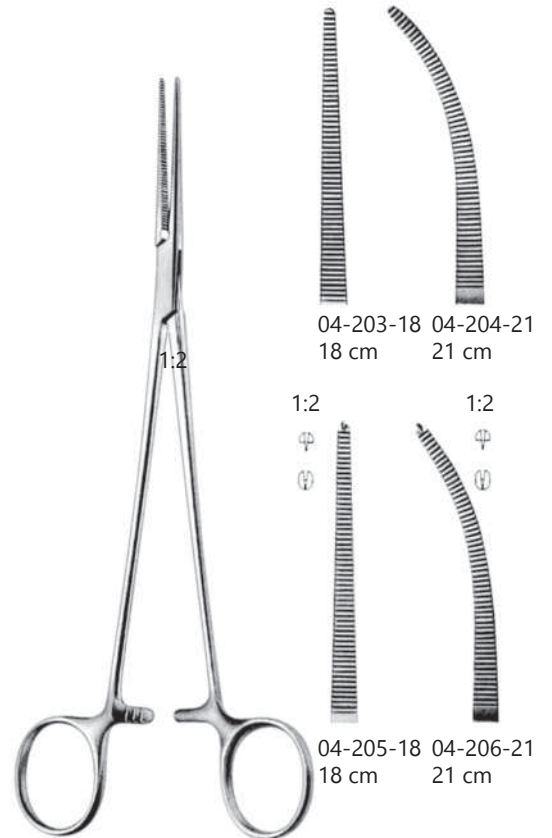

HALSTED-MOSQUITO
04-203-18 - 04-206-21

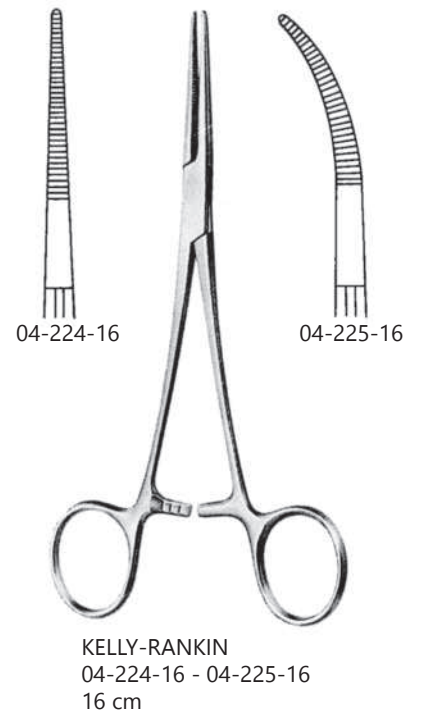
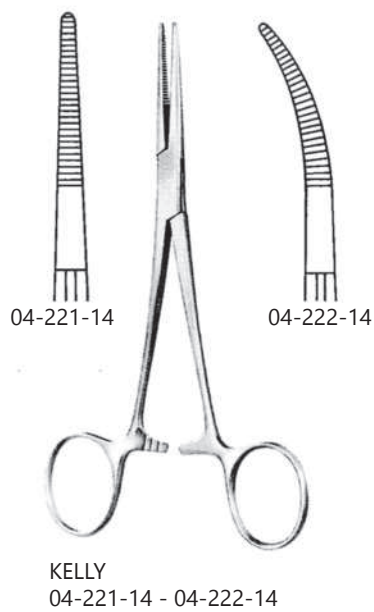
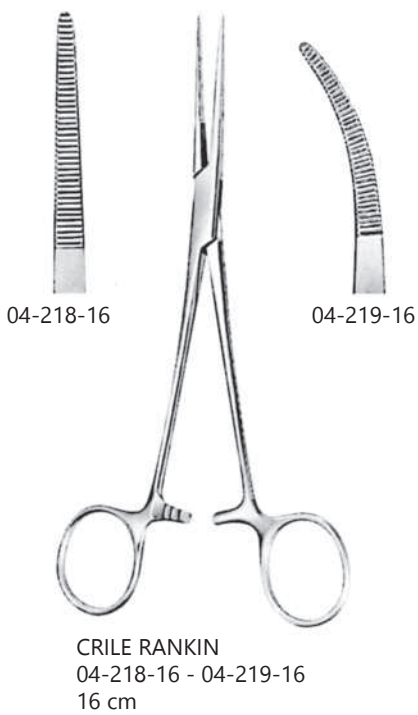
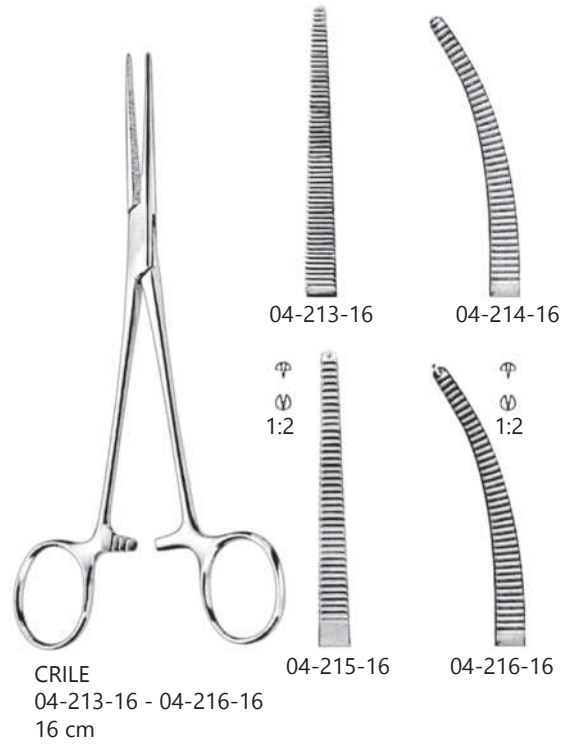



PEAN
04-227-14 - 04-242-30

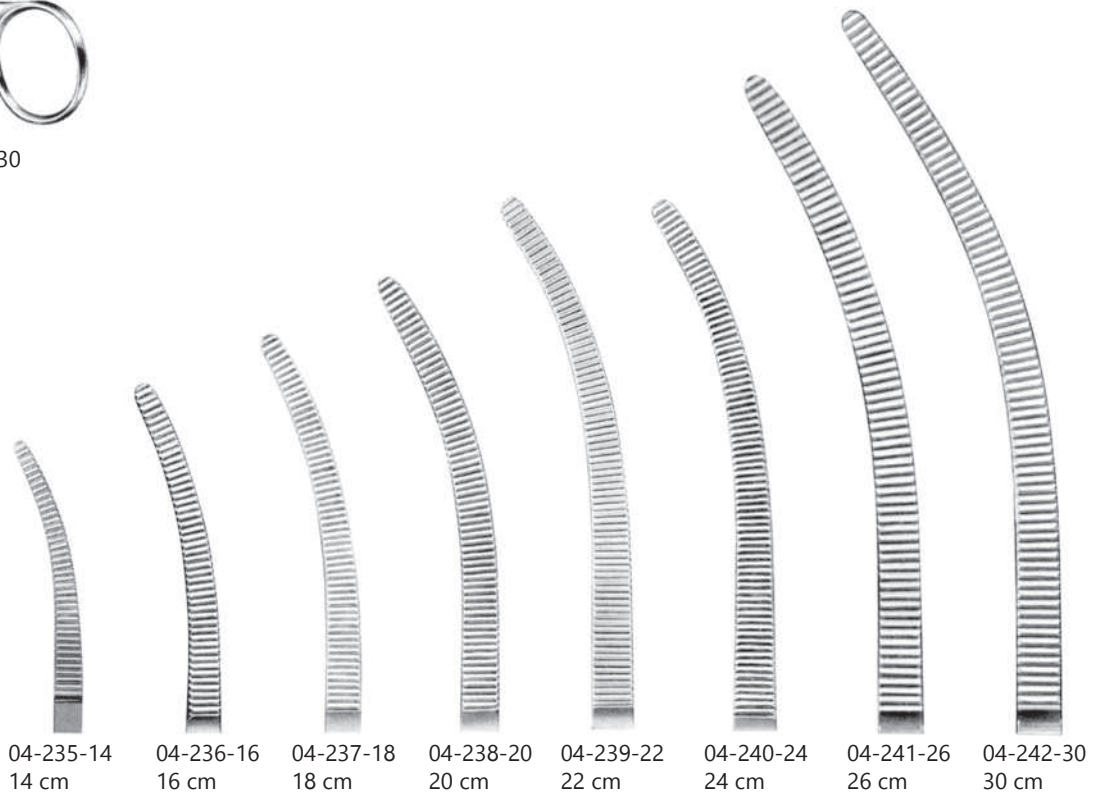
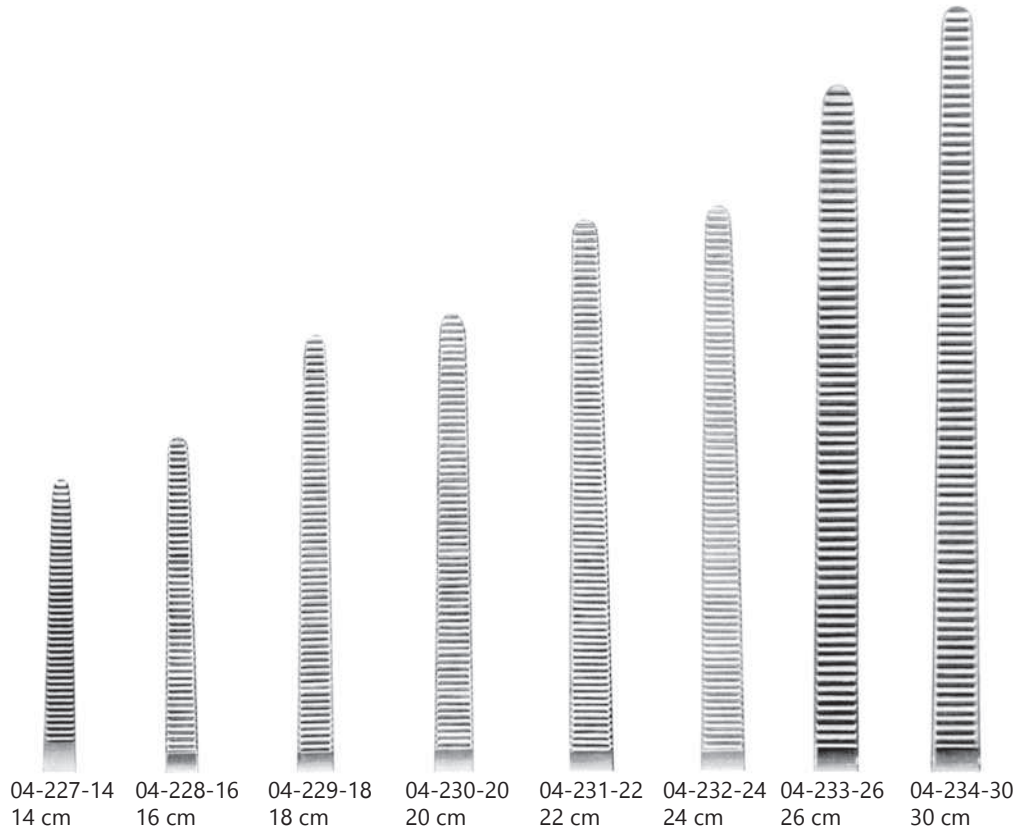



KOCHER-OCHSNER
04-244-14 - 04-259-30

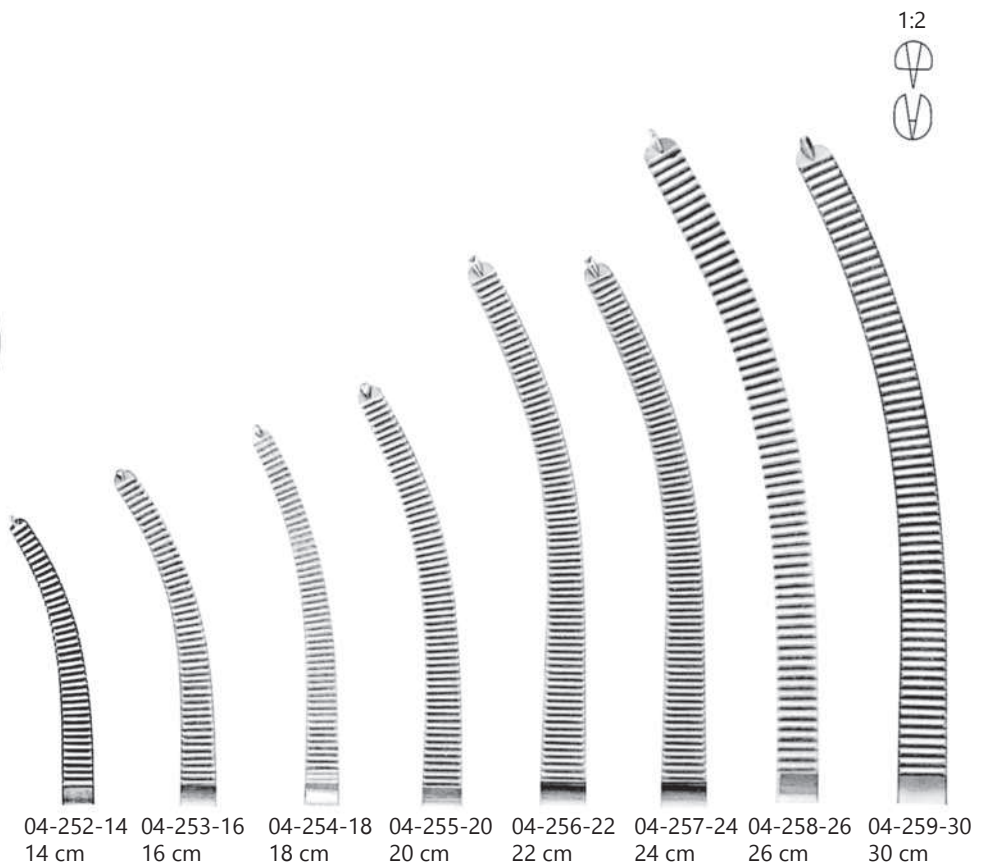
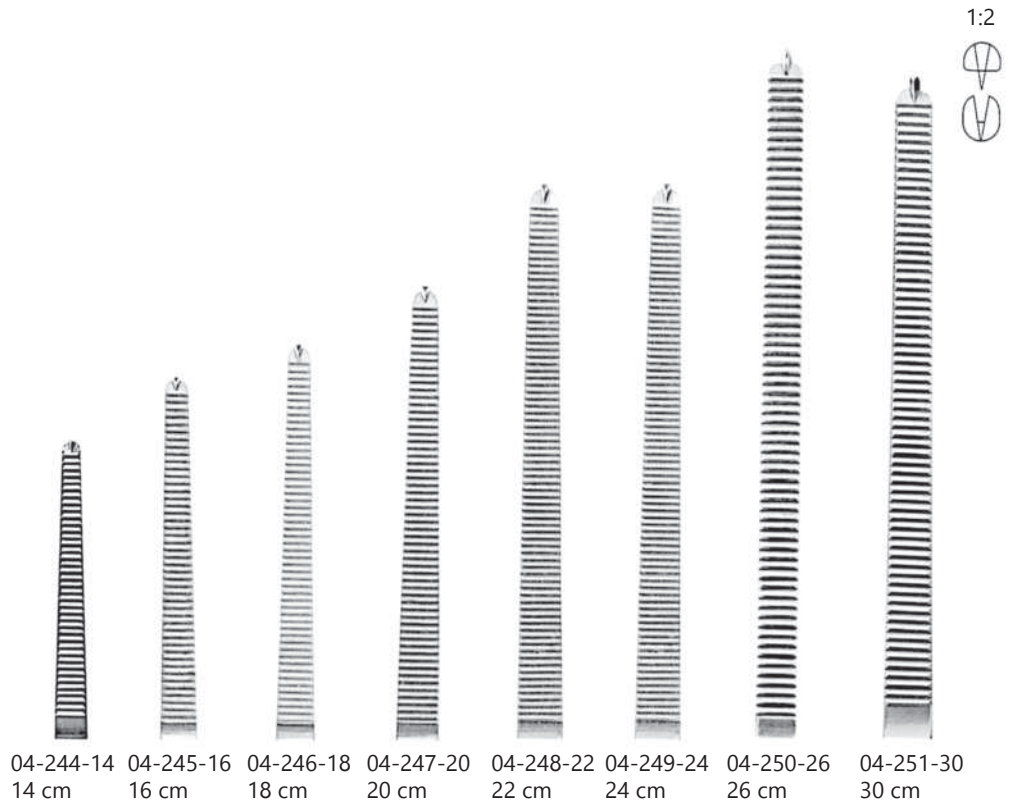



PEAN- DELICATE
 43-0666-14 - 043-0675-16



43-0666-13
 13 cm



43-0670-14
 14 cm



43-0673-13
 13 cm



43-0675-14
 14 cm



KOCHER - DELICATE
 43-0678-14 - 043-0685-14



43-0666-13
 13 cm



43-0682-14
 14 cm



43-0685-14
 14 cm



04-261-14
14 cm



04-262-16
16 cm



PEAN
04-261-14 - 04-262-16



BABY-OVERHOLT
04-264-13
13.5 cm

extra strong

1:2

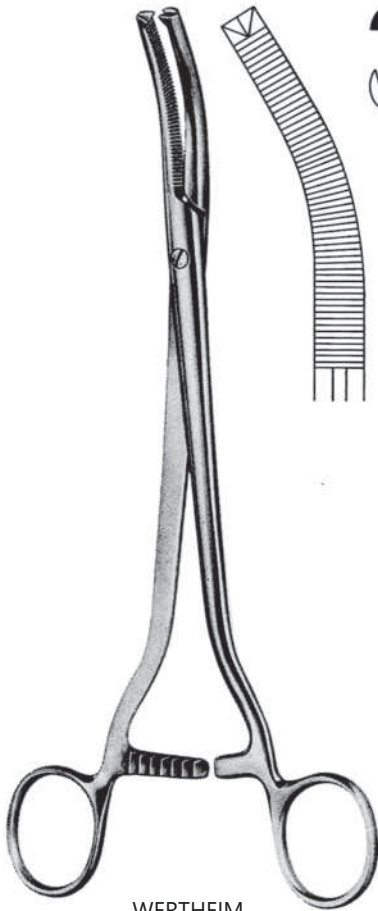

WERTHEIM
04-266-24
24 cm

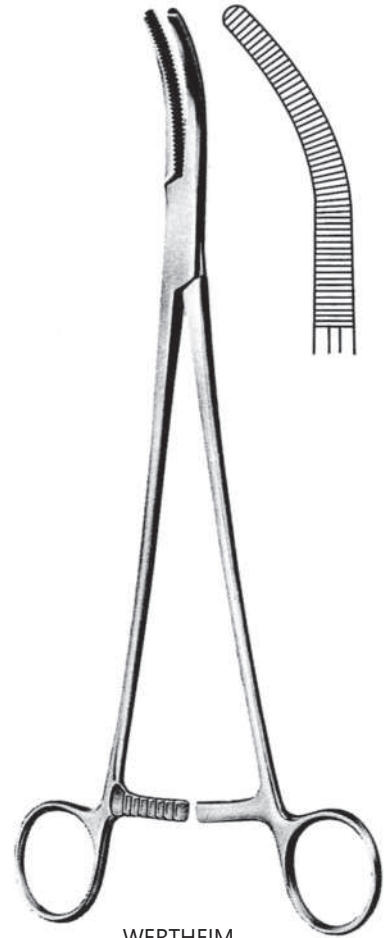

WERTHEIM
04-268-25
25 cm

1:2



04-270-23
slight curved

1:2



04-271-23
more curved

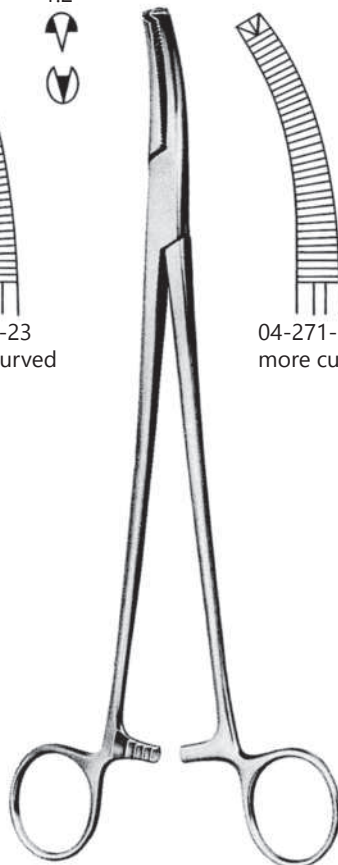

WERTHEIM
04-270-23 - 04-271-23
23 cm

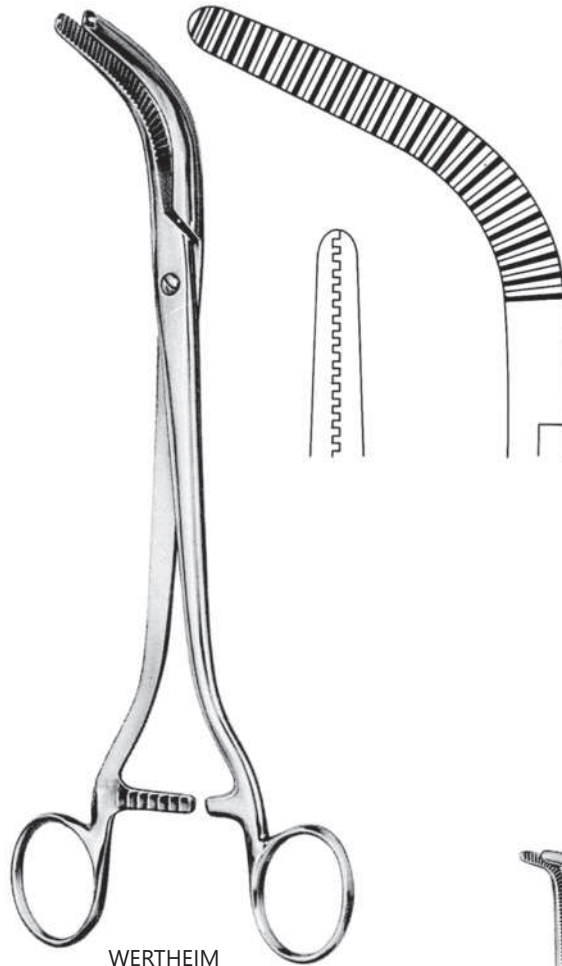

WERTHEIM
 04-273-27
 27 cm

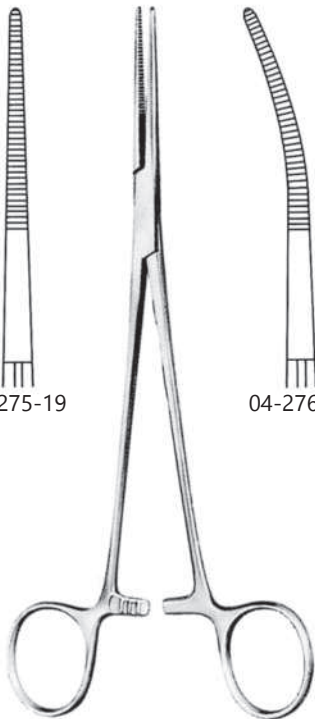

04-275-19

04-276-19

BIRKETT
 04-264-13 - 04-276-19
 19 cm

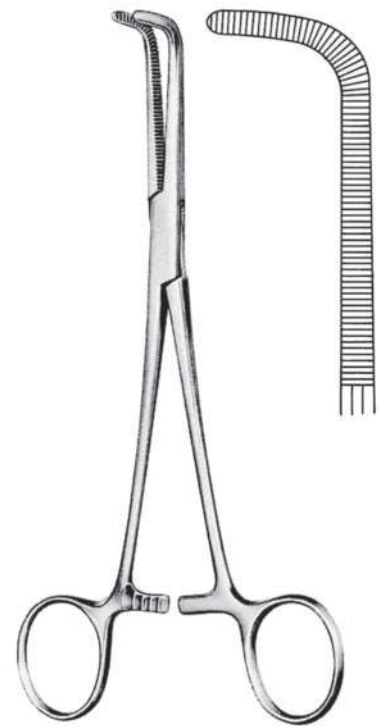

WIKSTROEM
 04-278-19
 19 cm



04-280-19

NEGUS
04-280-19 - 04-281-19
19 cm



04-281-19



DESJARDINS
04-283-21
21 cm

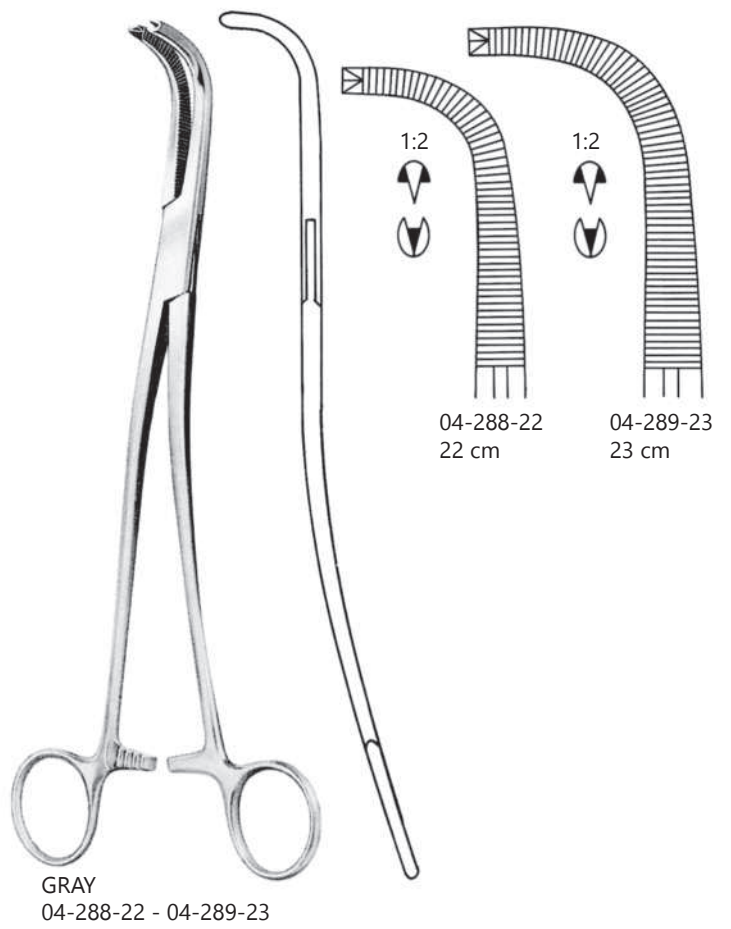
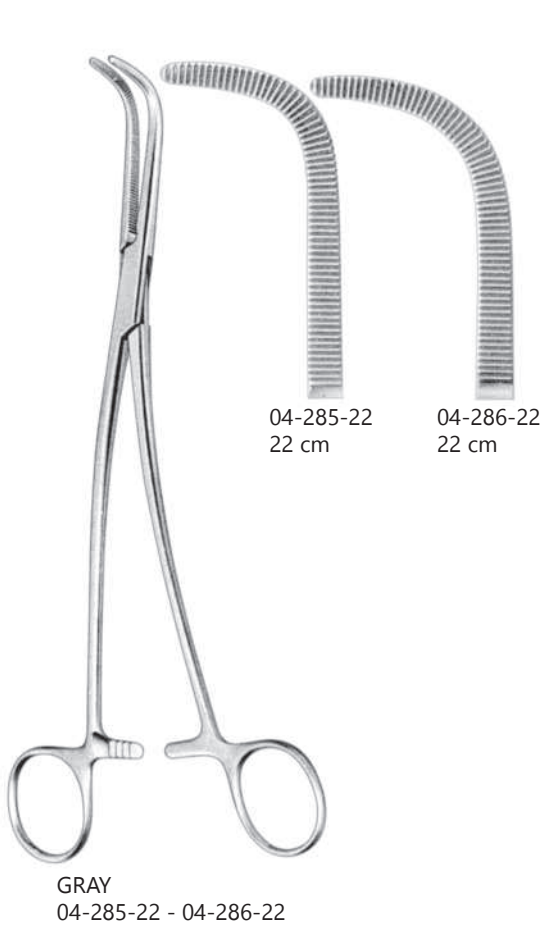

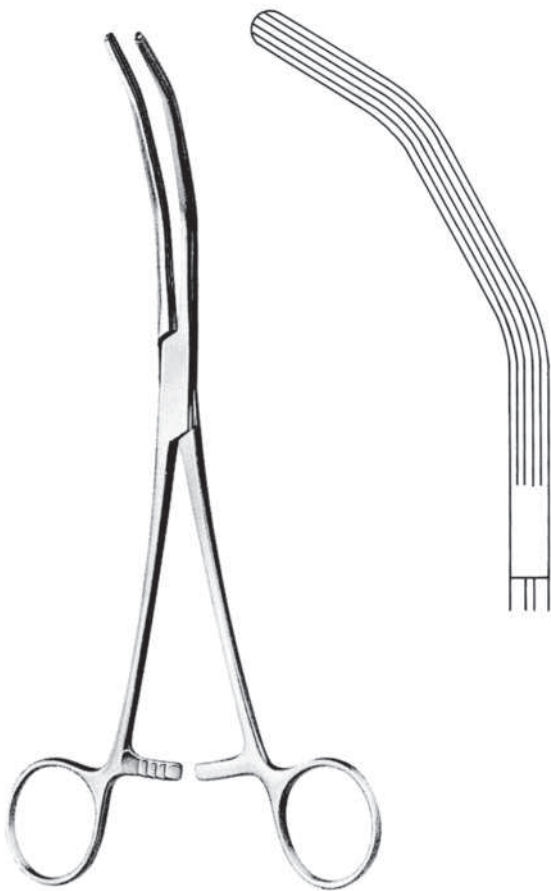

HERRICK
04-291-23
23 cm

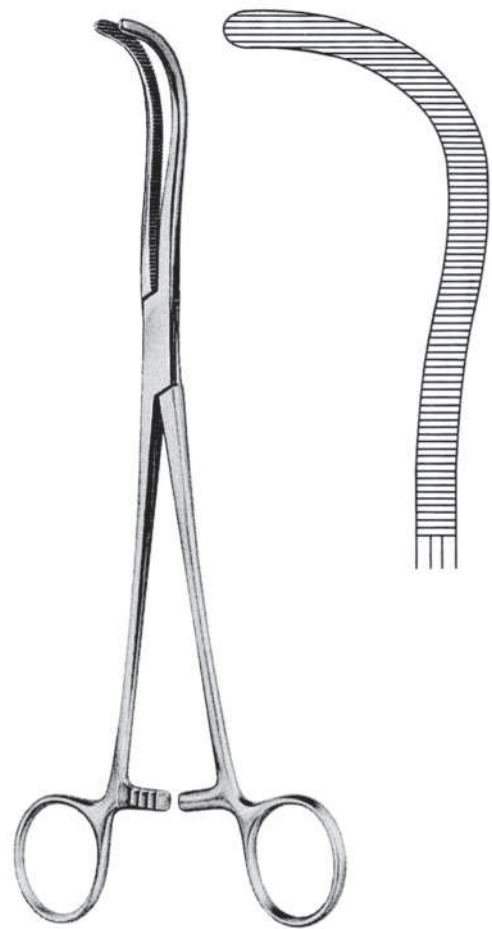

GUYON
04-293-23
23 cm

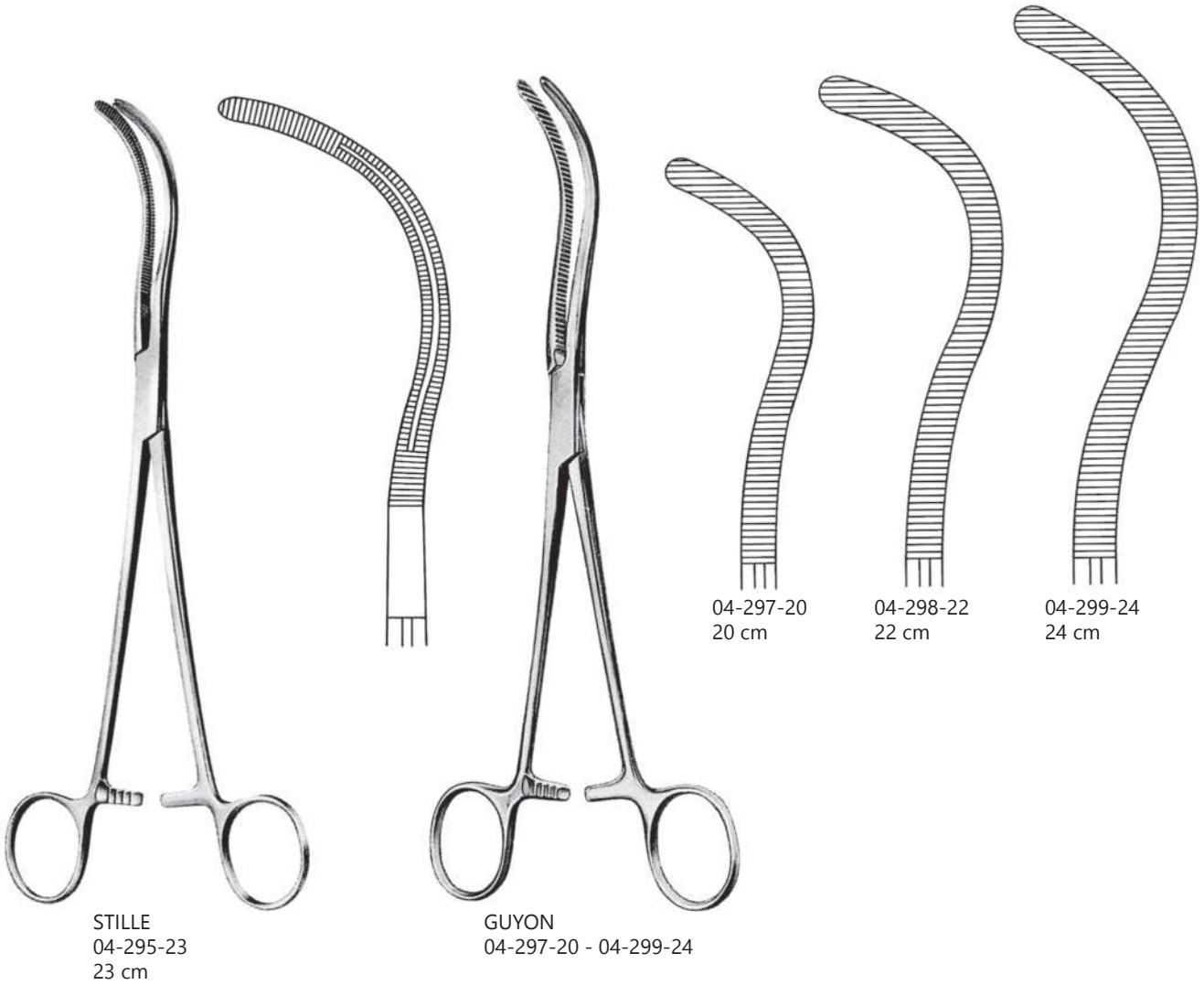

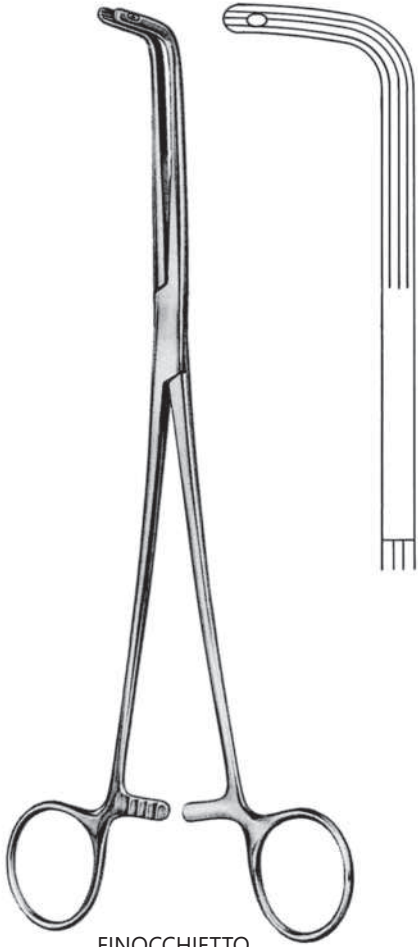

FINOCCHIETTO
 04-301-24
 24 cm

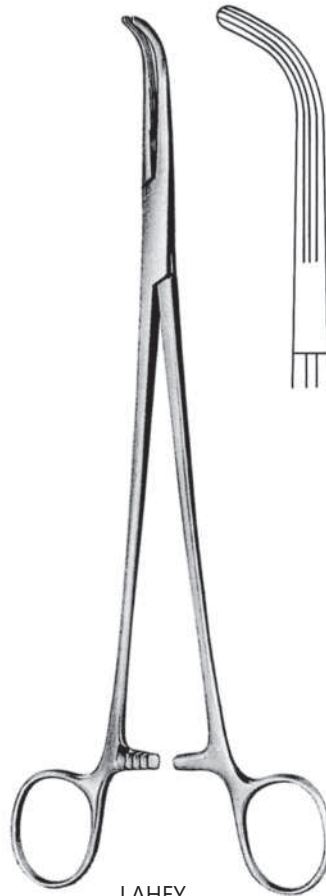

LAHEY
 04-303-23
 23 cm

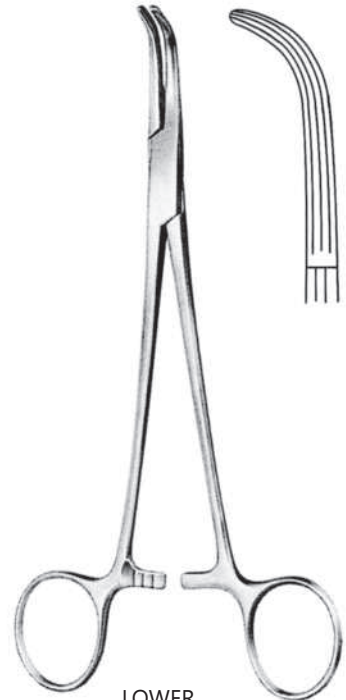

LOWER
 04-305-18
 18 cm



KANTROWITZ
 04-307-20 - 04-309-28

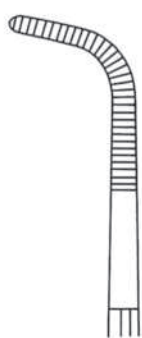

04-307-20
 20 cm



04-308-24
 24 cm



04-309-28
 28 cm

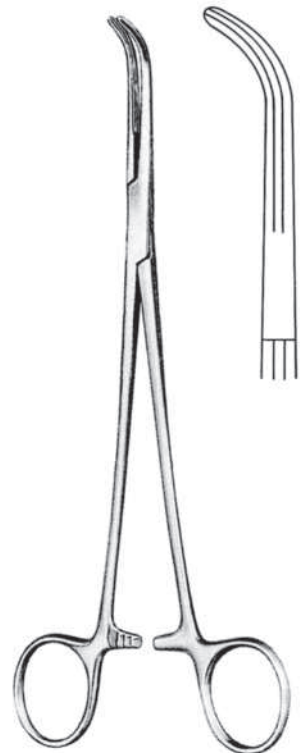

LAHEY
 04-311-19
 19 cm

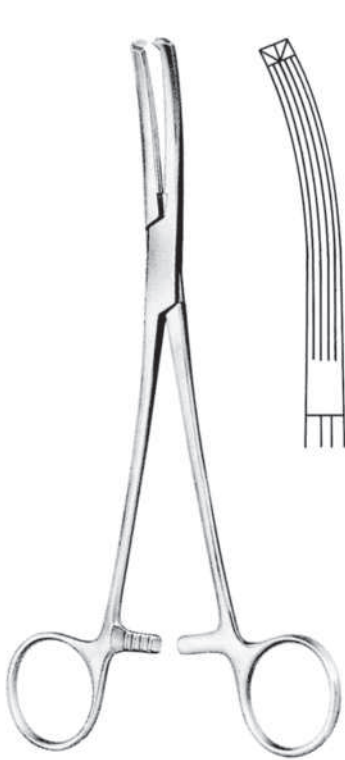

LONG
 04-313-19
 19 cm

1:2

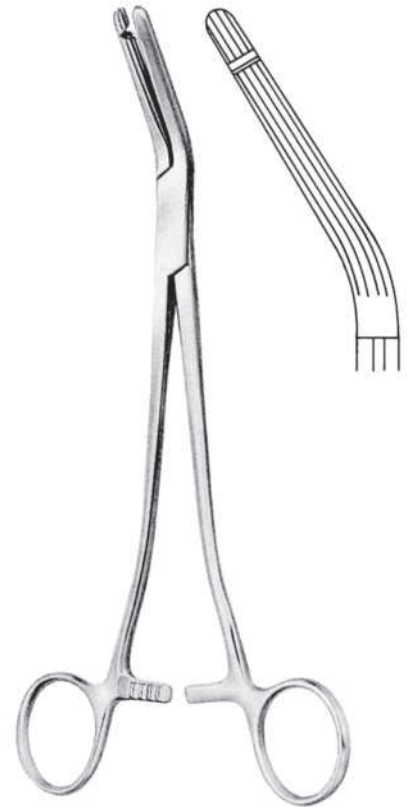

GALAND
 04-315-21
 21 cm

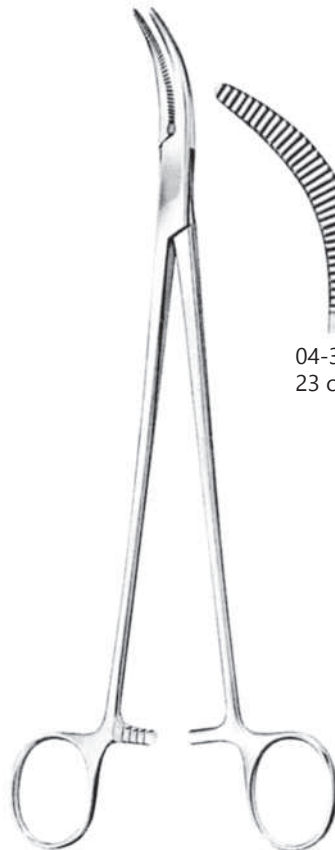

MOYNIHAN
 04-317-23 - 04-318-24

04-317-23
 23 cm

04-318-24
 24 cm

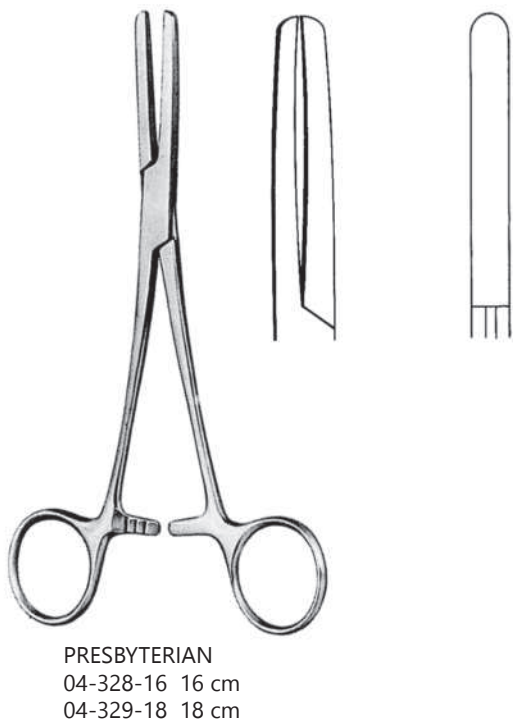
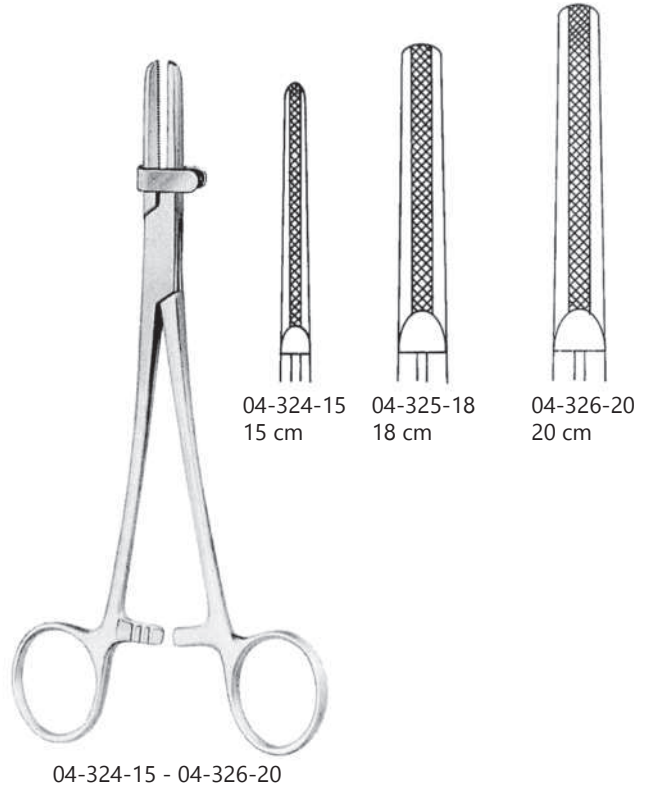
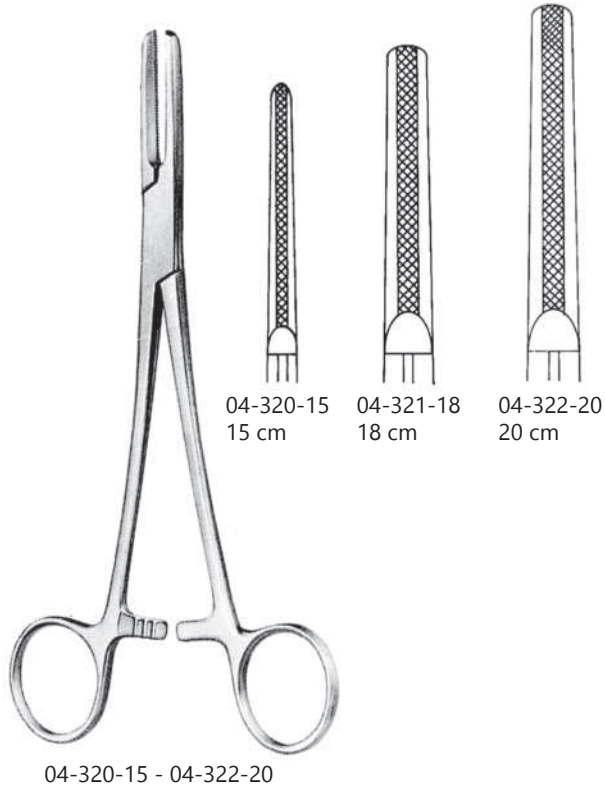



ROEDER
04-333-13 13 cm
04-334-15 15 cm



BACKHAUS
04-336-08 8 cm
04-337-11 11 cm
04-338-13 13 cm

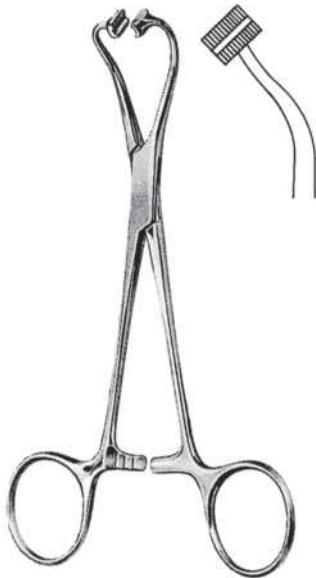

PEERS
04-340-14
14.5 cm

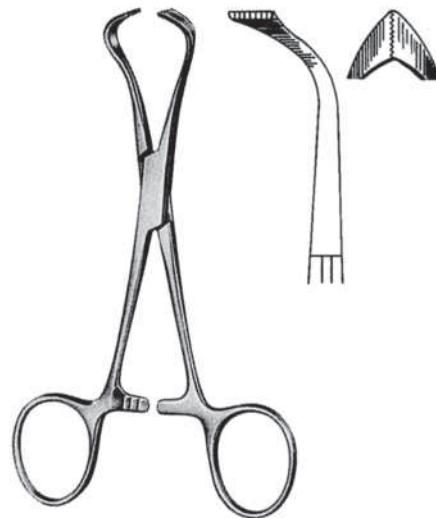

LORNA
04-342-10 10 cm
04-343-13 13 cm



LANE
04-345-15 15 cm
04-336-18 18 cm
04-337-20 20 cm



DOYEN
04-349-18
18 cm

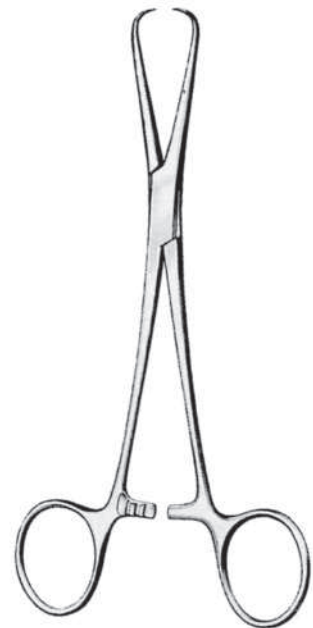

BERNHARD
04-351-16
16.5 cm



JONES
04-353-05 5 cm
04-354-09 9 cm



ENGL.MODEL
04-356-09
9 cm



SCHAEDEL
04-358-09
9 cm

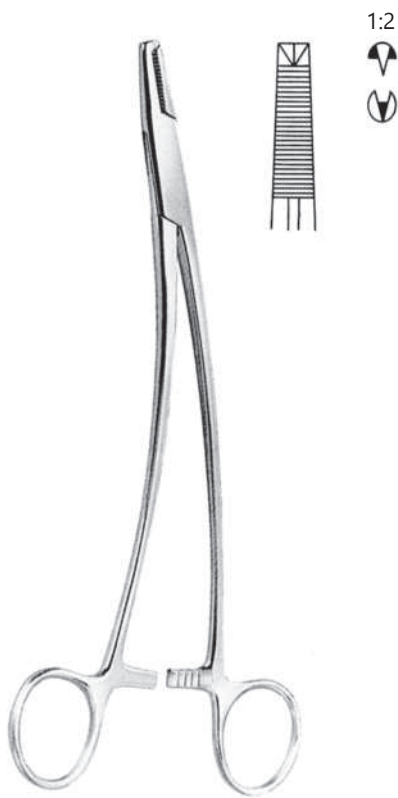

SCHINDLER
04-360-20
20 cm

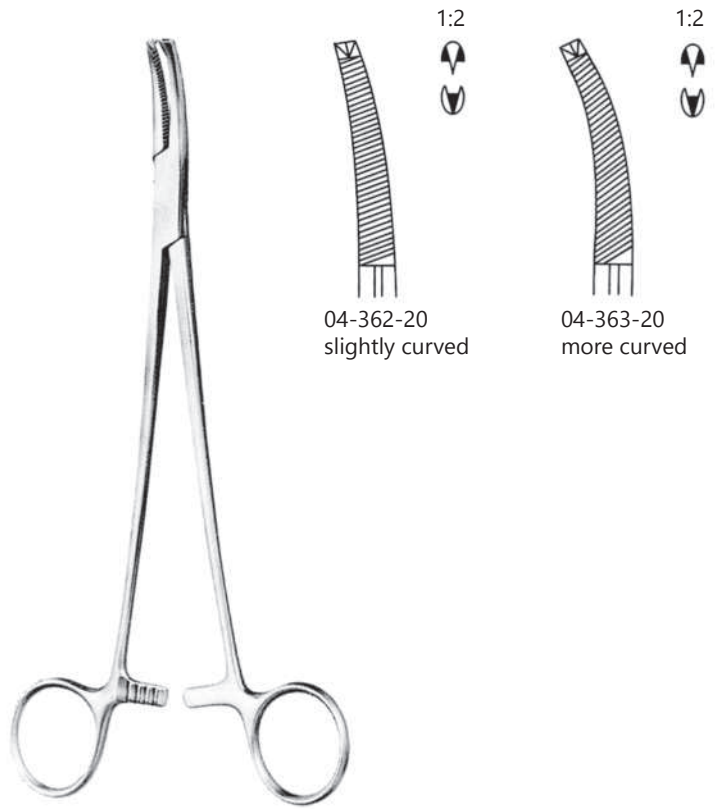

04-362-20
slightly curved

04-363-20
more curved

FAURE
04-362-20 - 04-363-20
20 cm

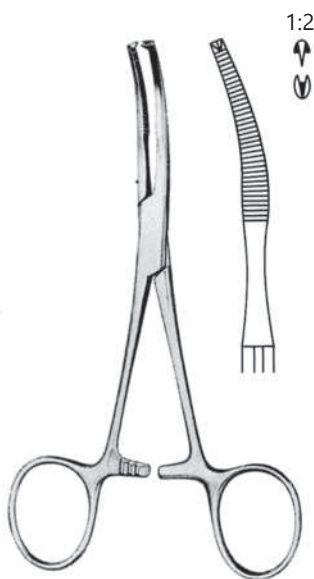

BABY-MIKULICZ
04-365-14
14 cm

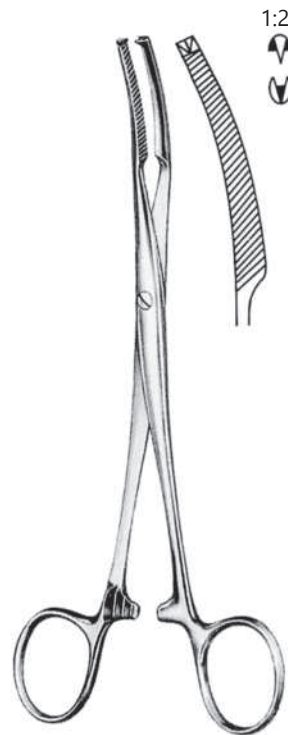

MIKULICZ
04-367-18
18 cm

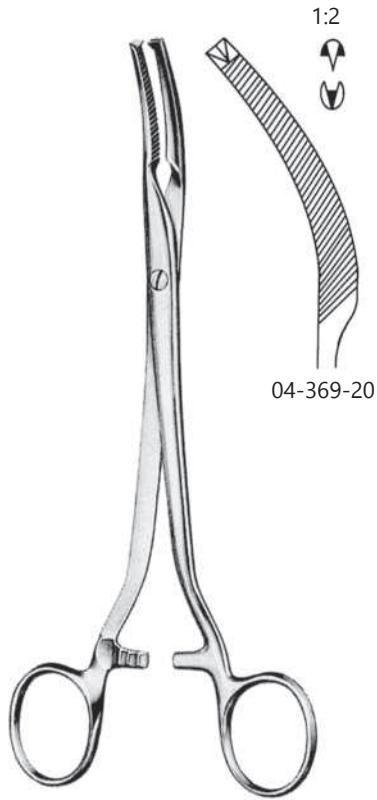

MIKULICA
04-367-20 - 04-370-20
20 cm



04-370-20

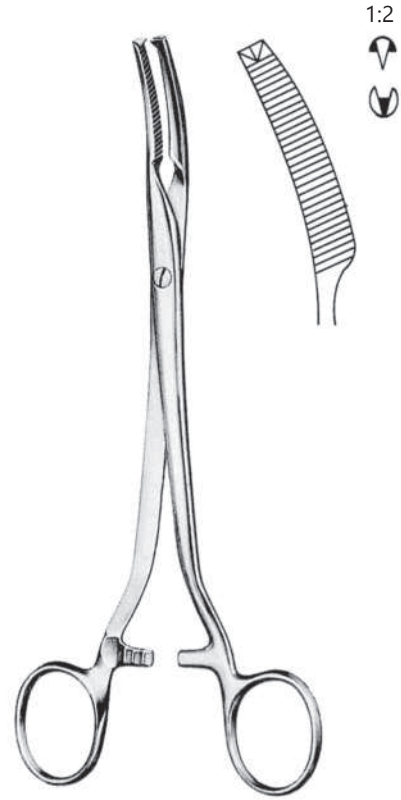

MIKULICA
04-370-20
20 cm

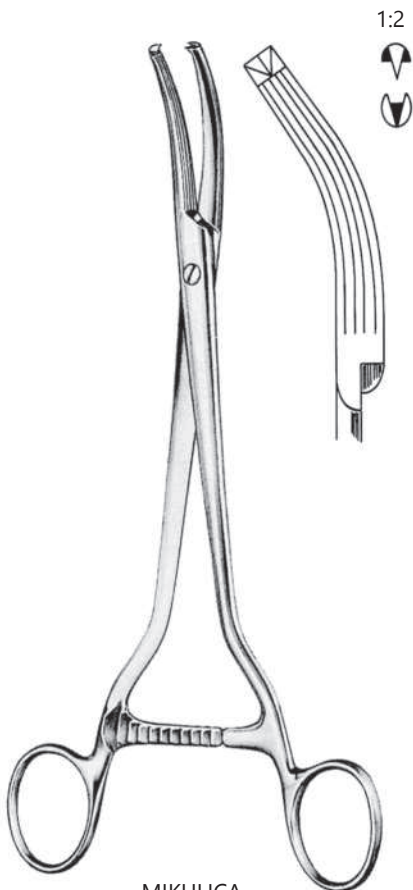

MIKULICA
04-373-23
23 cm

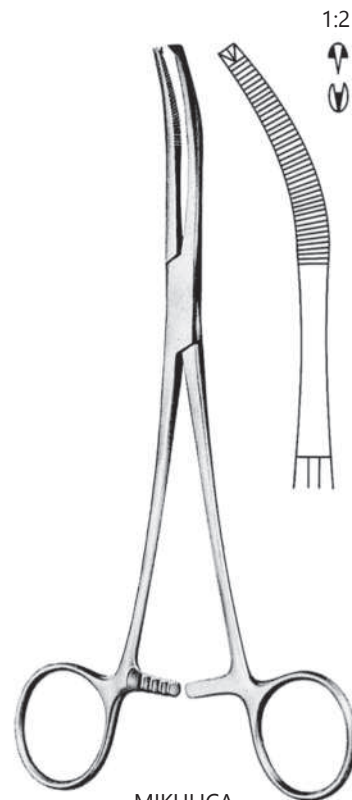

MIKULICA
04-375-20
20 cm



PARATT
 04-377-15
 15 cm

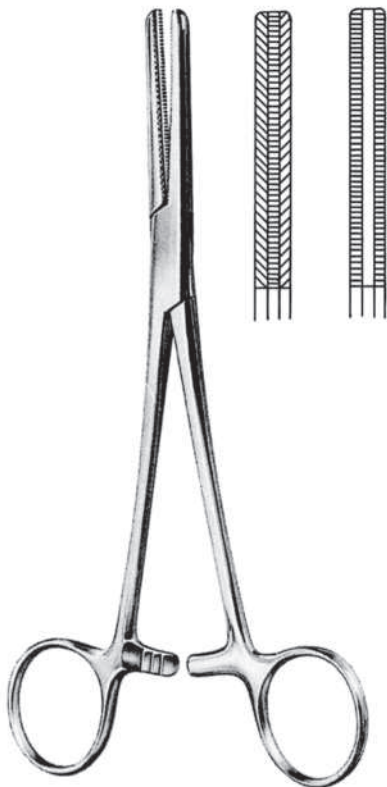

FERGUSSON
 04-379-16 16 cm
 04-380-20 20 cm

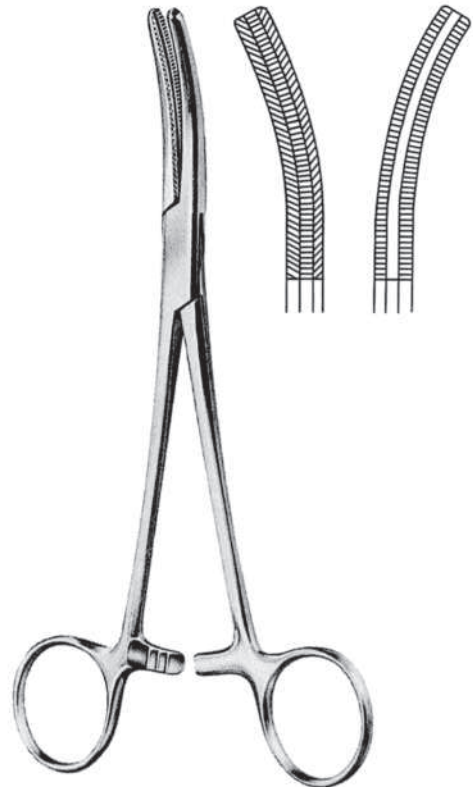

FERGUSSON
 04-381-16 16 cm
 04-382-20 20 cm



PHANEUF
04-384-21 - 04-385-21
21.5 cm

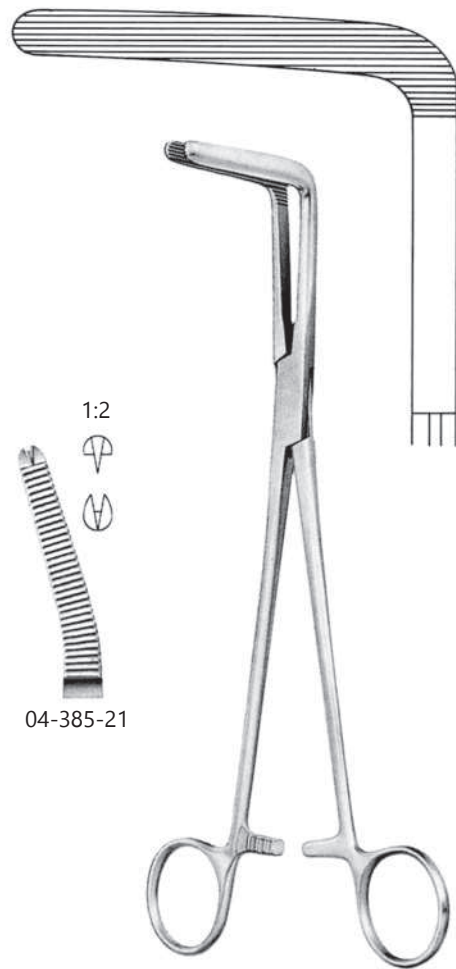

WERTHEM-CULLEN
04-387-21
21 cm

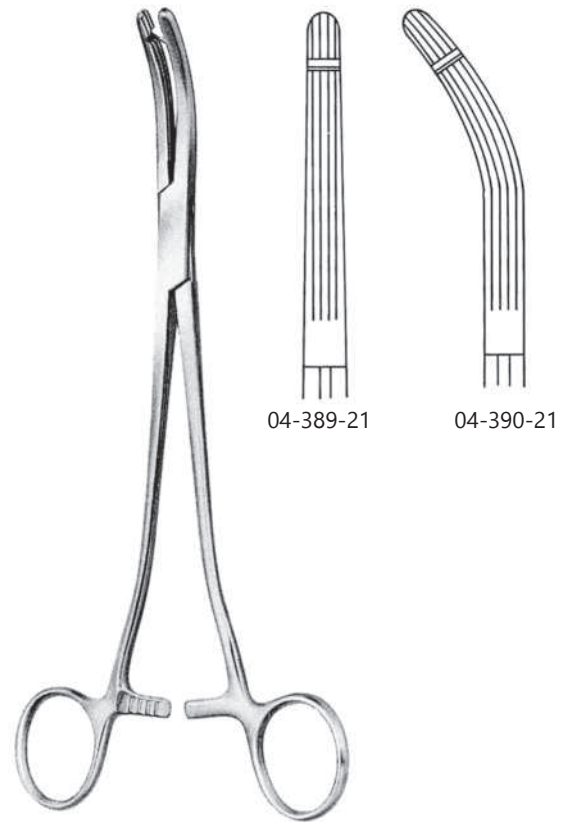

HEANEY-BALLANTINE
04-389-21 - 04-390-21
21 cm

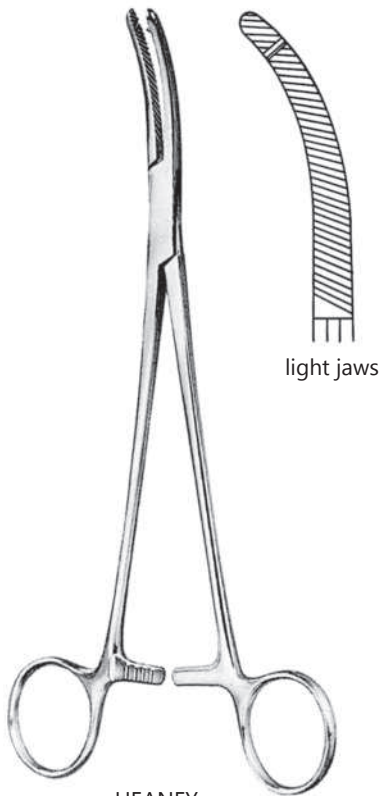

light jaws

HEANEY
 04-392-21
 21 cm

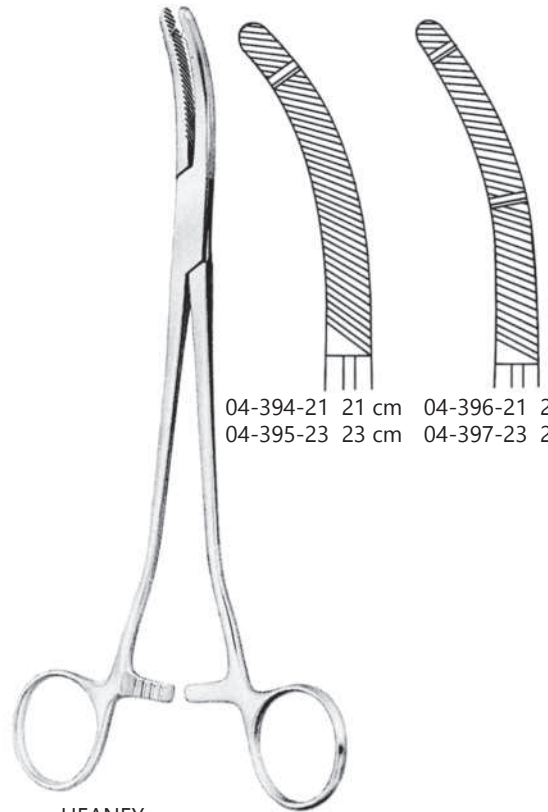

04-394-21 21 cm
 04-395-23 23 cm
 04-396-21 21 cm
 04-397-23 23 cm

HEANEY
 04-394-21 - 04-397-23



HEANEY-REZAK
 04-399-21
 21 cm

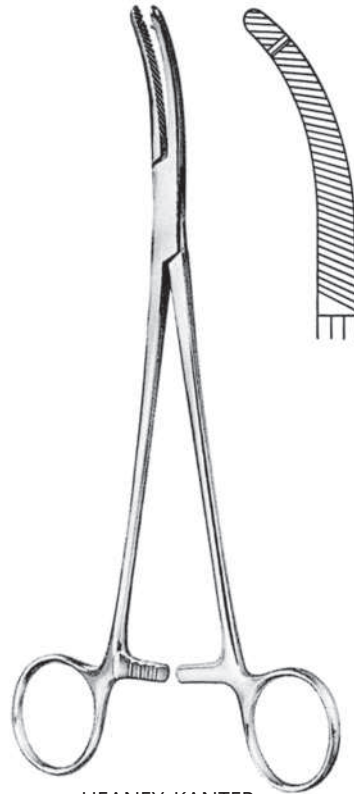

HEANEY-KANTER
04-401-21
21 cm

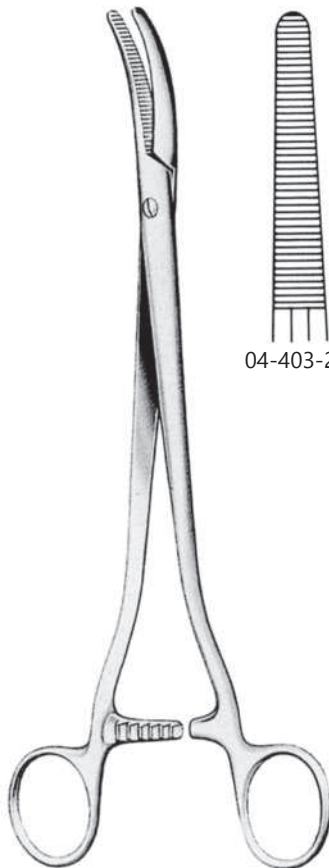

SEGOND-LANDU
04-403-24 - 04-404-24
24 cm



04-403-24



04-403-24

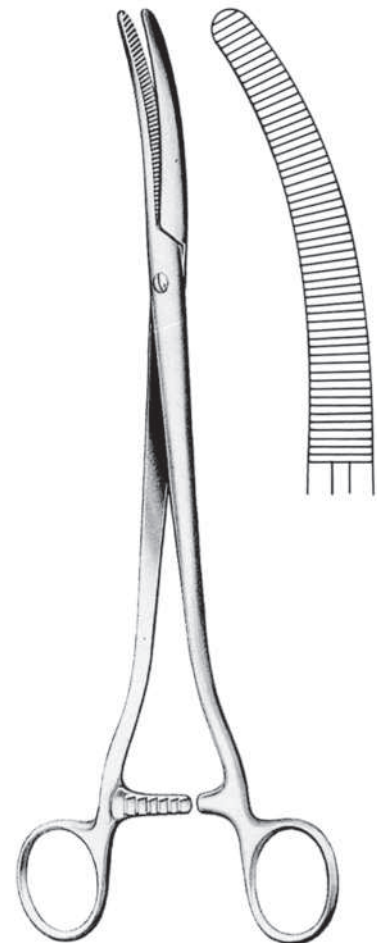

FAURE
04-405-25
25 cm

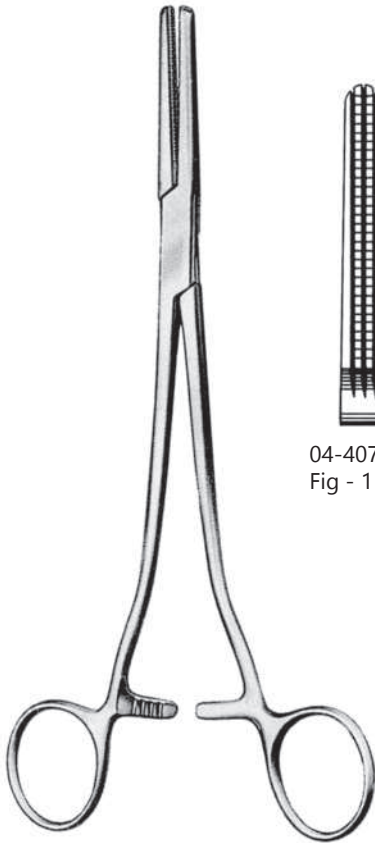

PARAMETRIUM
04-407-21 - 04-410-21
21 cm

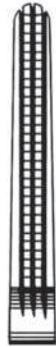

04-407-21
Fig - 1



04-408-21
Fig - 2



04-408-21
Fig - 3



04-410-21
Fig - 4

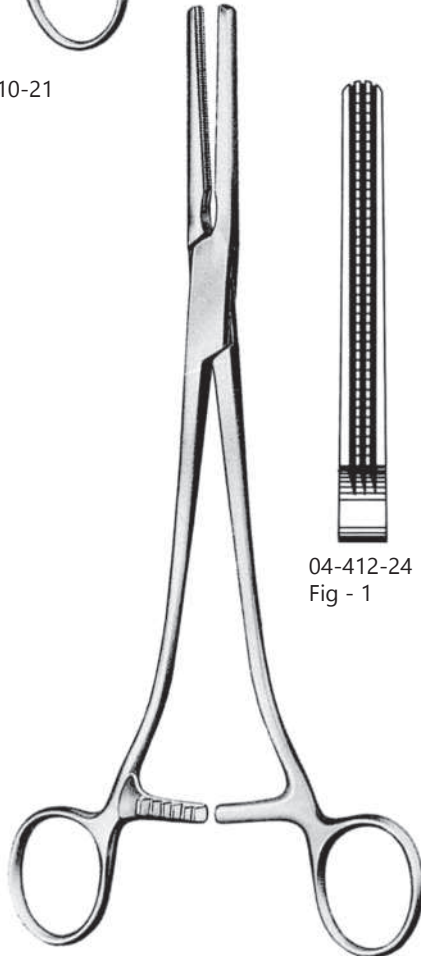

PARAMETRIUM
04-412-24 - 04-415-24
24 cm



04-412-24
Fig - 1



04-413-24
Fig - 2



04-414-24
Fig - 3



04-415-24
Fig - 4

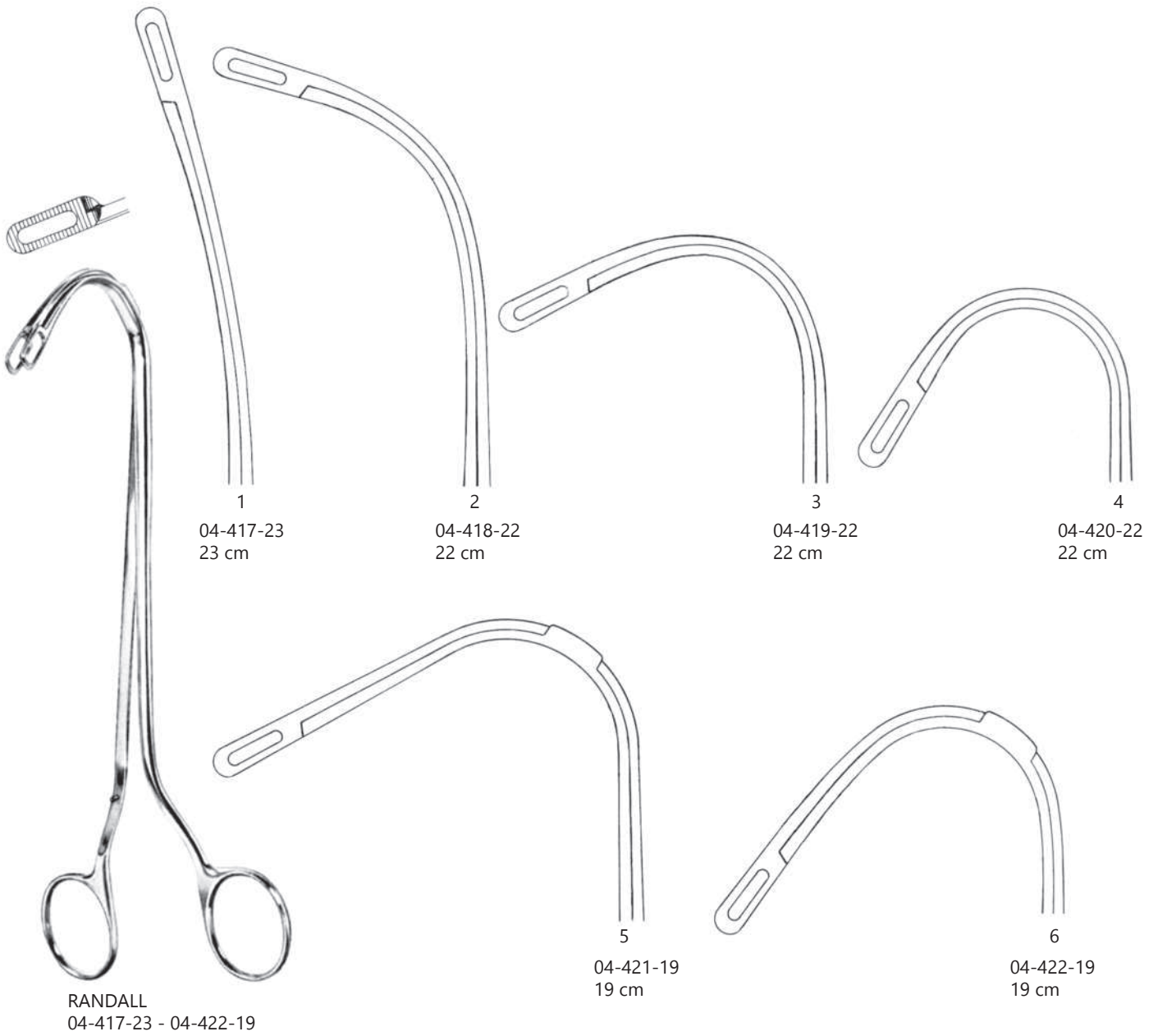



05

Forceps
Pinzetten
Pinzas

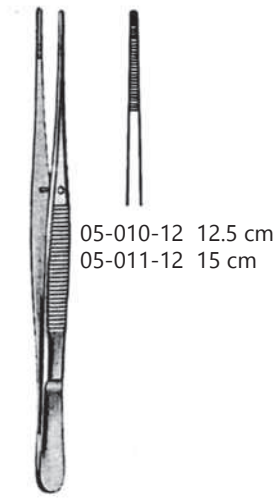

SEMKEN
 05-010-12 - 05-011-15

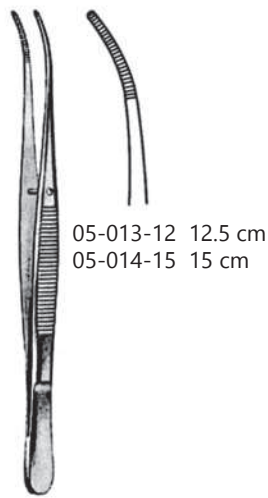

SEMKEN
 05-013-12 - 05-014-15

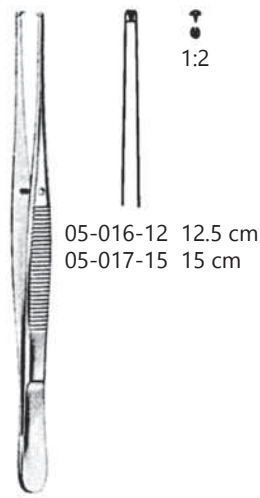

SEMKEN
 05-016-12 - 05-017-15

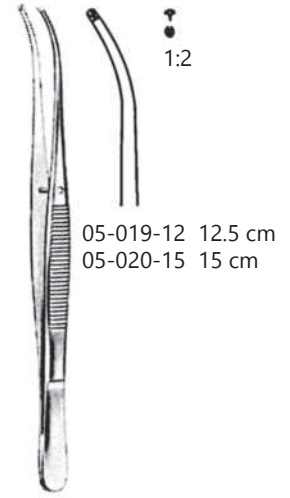

SEMKEN
 05-019-12 - 05-020-15

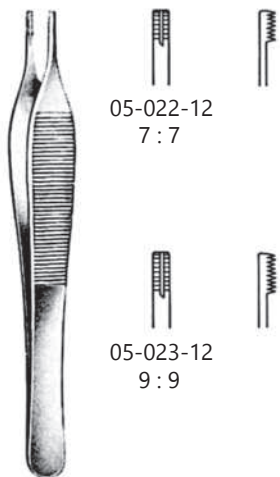

ADSON-BROWN
 05-022-12 - 05-023-12
 12 cm

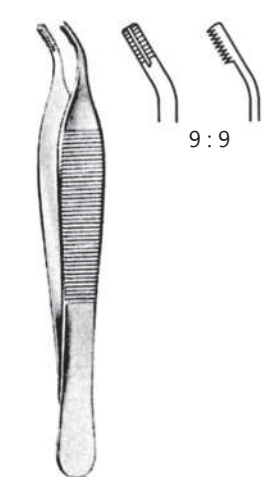

ADSON-BROWN
 05-025-12
 12 cm

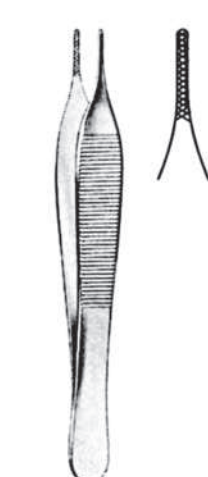

ADSON
 05-027-12
 12 cm

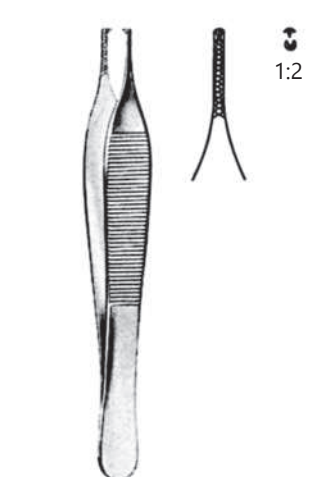

ADSON
 05-029-12
 12 cm

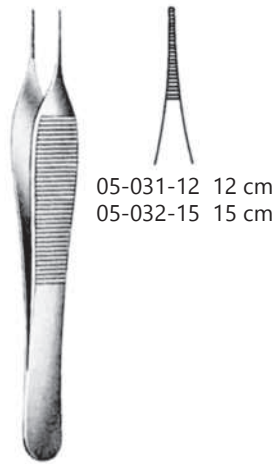

05-031-12 12 cm
 05-032-15 15 cm

MICRO ADSON
 05-031-12 - 05-032-15

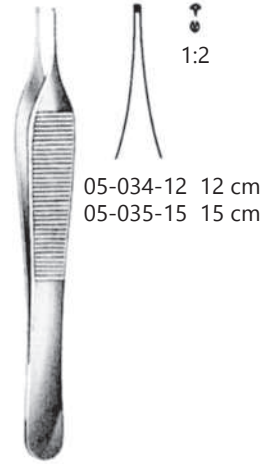

05-034-12 12 cm
 05-035-15 15 cm

MICRO ADSON
 05-034-12 - 05-035-15

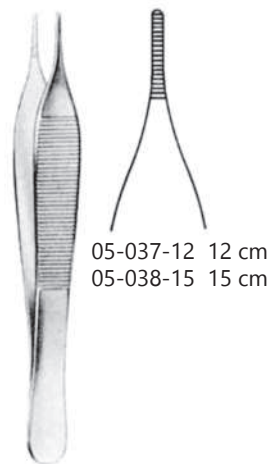

05-037-12 12 cm
 05-038-15 15 cm

ADSON
 05-037-12 - 05-038-15

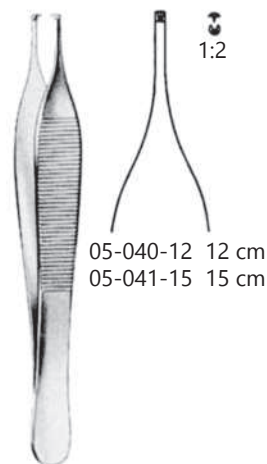

05-040-12 12 cm
 05-041-15 15 cm

ADSON
 05-040-12 - 05-041-15



DE BAKLEY
 05-043-16 - 05-045-16
 16 cm



05-047-15 - 05-048-15
 15 cm



05-050-12 - 05-055-12
 12 cm

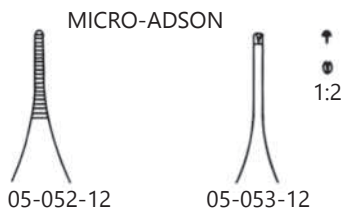



- 05-057-12 12 cm
- 05-058-13 13 cm
- 05-059-14 14.5 cm
- 05-060-15 15.5 cm
- 05-061-18 18 cm
- 05-062-21 21 cm
- 05-063-25 25 cm
- 05-064-31 31 cm

MODELL USA
 05-057-12 - 05-064-31



1:2

- 05-066-12 12 cm
- 05-067-13 13 cm
- 05-068-14 14.5 cm
- 05-069-15 15.5 cm
- 05-070-18 18 cm
- 05-071-21 21 cm
- 05-072-25 25 cm
- 05-073-31 31 cm

MODELL USA
 05-066-12 - 05-073-31



2:3

- 05-075-12 12 cm
- 05-076-13 13 cm
- 05-077-14 14.5 cm
- 05-078-15 15.5 cm
- 05-079-18 18 cm
- 05-080-21 21 cm
- 05-081-25 25 cm
- 05-082-31 31 cm

MODELL USA
 05-075-12 - 05-082-31



- 44-0300-12 12 cm
- 44-0304-13 13 cm
- 44-0308-14 14.5 cm
- 44-0312-15

MODELL USA
 05-084-12 - 05-087-15
 narrow



1:2

- 44-0316-12 12 cm
- 44-0320-13 13 cm
- 44-0324-14 14.5 cm

MODELL USA
 05-089-12 - 05-091-14
 narrow



STANDARD
 05-093-10 - 05-101-30



05-093-10
 10.5 cm



05-094-11
 11.5 cm



05-095-13
 13.0 cm



05-096-14
 14.5 cm



05-097-16
 16.0 cm

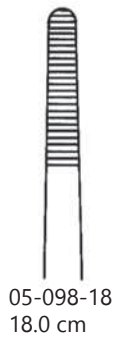

05-098-18
 18.0 cm



05-099-20
 20.0 cm

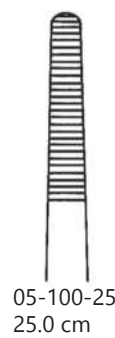

05-100-25
 25.0 cm



05-101-30
 30.0 cm



- 05-103-10 10.5 cm
- 05-104-11 11.5 cm
- 05-105-13 13.0 cm
- 05-106-14 14.5 cm
- 05-107-16 16.0 cm
- 05-108-18 18.0 cm
- 05-109-20 20.0 cm
- 05-110-25 25.0 cm
- 05-111-31 30.0 cm

05-103-10 - 05-111-30
 narrow



- 05-113-10 10.5 cm
- 05-114-11 11.5 cm
- 05-115-13 13.0 cm
- 05-116-14 14.5 cm
- 05-117-16 16.0 cm
- 05-118-18 18.0 cm
- 05-119-20 20.0 cm
- 05-120-25 25.0 cm
- 05-121-30 30.0 cm

05-103-10 - 05-121-30
 narrow



- 1:2
- 05-123-10 10.5 cm
 - 05-124-11 11.5 cm
 - 05-125-13 13.0 cm
 - 05-126-14 14.5 cm
 - 05-127-16 16.0 cm
 - 05-128-18 18.0 cm
 - 05-129-20 20.0 cm
 - 05-130-25 25.0 cm
 - 05-131-30 30.0 cm



- 1:2
- 05-133-10 10.5 cm
 - 05-134-11 11.5 cm
 - 05-135-13 13.0 cm
 - 05-136-14 14.5 cm
 - 05-137-16 16.0 cm
 - 05-138-18 18.0 cm
 - 05-139-20 20.0 cm
 - 05-140-25 25.0 cm
 - 05-141-31 30.0 cm

05-133-10 - 05-141-30



- 05-143-13 13.0 cm
- 05-144-14 14.5 cm

05-143-13 - 05-144-14
 delicate



- 1:2
- 05-146-13 13.0 cm
 - 05-147-14 14.5 cm

05-146-13 - 05-147-14
 delicate

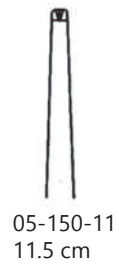

05-149-10 - 05-157-30

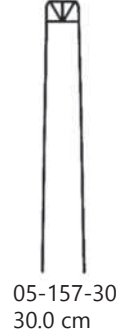
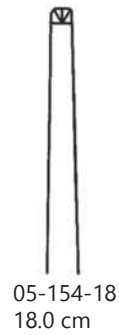



3:4

- 05-159-13 13 cm
- 05-160-14 14 cm
- 05-161-16 16 cm

05-159-13 - 05-161-16



4:5

- 05-163-13 13 cm
- 05-164-14 14 cm
- 05-165-16 16 cm

05-163-13 - 05-165-16



2:3

- 05-167-13 13 cm
- 05-168-14 14 cm
- 05-169-16 16 cm
- 05-170-18 18 cm
- 05-171-20 20 cm
- 05-172-25 25 cm
- 05-173-30 30 cm

05-167-13 - 05-173-30





1:2

MODELL USA
05-175-14
14 cm

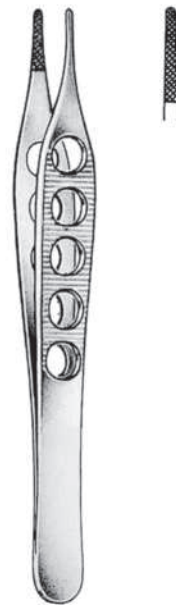

MODELL USA
05-177-14
14 cm



ADSON
05-179-12
12 cm



GRUENWALD (JANSEN)
 05-181-20
 20 cm

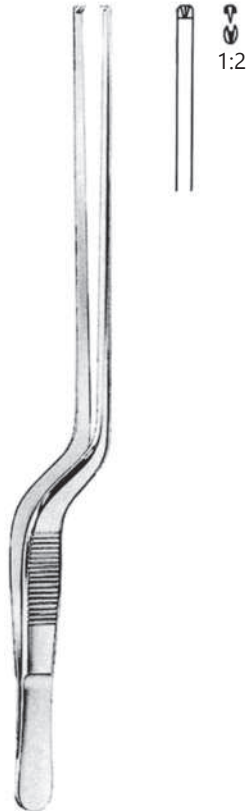

GRUENWALD
 05-183-20
 20 cm

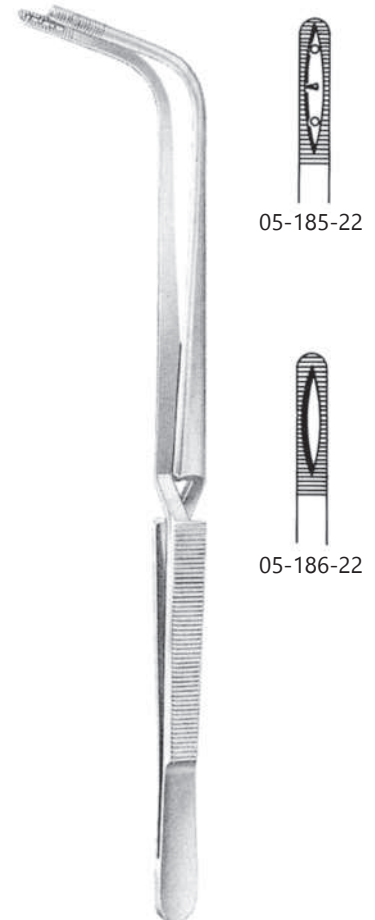

JACKSON
 05-185-22 - 05-186-22
 22 cm

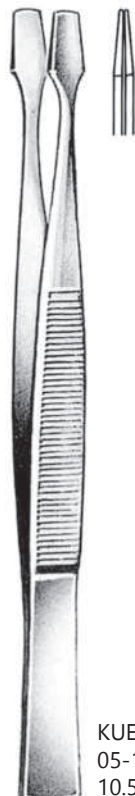

KUEHNE
 05-188-10
 10.5 cm



KUEHNE
 05-190-10
 10.5 cm



DOUGLAS
05-192-09
9 cm

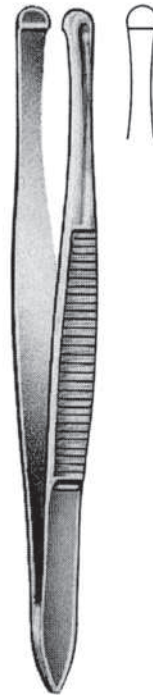

DOUGLAS
05-192-09
9 cm



LITTAUER
05-196-08
8.5 cm



05-198-09
9 cm



BARRAQUER
05-200-10
10.5 cm

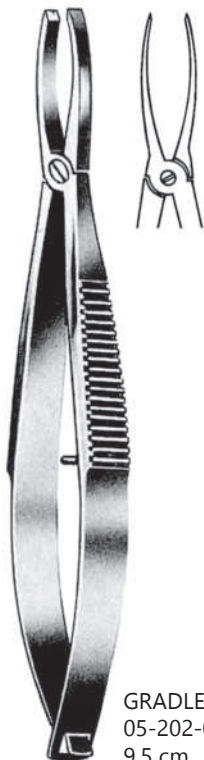

GRADLE
05-202-09
9.5 cm



ZIEGLER
05-204-09
9 cm



05-206-07 7.5 cm
05-207-09 9 cm
05-208-11 11 cm

FEILCHENFELD
05-206-07 - 05-208-11



WALTER-CARMALT
05-210-10
10.5 cm



WALTER-CARMALT
05-212-10
10.5 cm



HUNTER
05-215-10
10.5 cm



HUNTER
05-216-10
10.5 cm



- 05-218-08 8 cm
- 05-219-09 9 cm
- 05-220-10 10.5 cm
- 05-221-11 11.5 cm
- 05-222-12 12.5 cm
- 05-223-14 14.5 cm



- 05-225-08 8 cm
- 05-226-09 9 cm
- 05-227-10 10.5 cm
- 05-228-11 11.5 cm
- 05-229-12 12.5 cm
- 05-230-14 14.5 cm



- 05-232-08 8 cm
- 05-233-09 9 cm
- 05-234-10 10.5 cm
- 05-235-11 11.5 cm
- 05-236-12 12.5 cm
- 05-237-14 14.5 cm



- 05-239-08 8 cm
- 05-240-09 9 cm
- 05-241-10 10.5 cm
- 05-242-11 11.5 cm
- 05-243-12 12.5 cm
- 05-244-14 14.5 cm



05-246-08 8 cm
05-247-09 9 cm
05-248-10 10.5 cm
05-249-11 11.5 cm
05-250-12 12.5 cm
05-251-14 14.5 cm

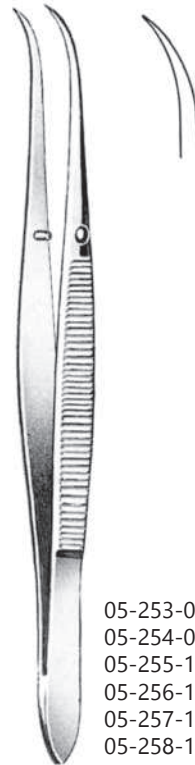

05-253-08 8 cm
05-254-09 9 cm
05-255-10 10.5 cm
05-256-11 11.5 cm
05-257-12 12.5 cm
05-258-14 14.5 cm

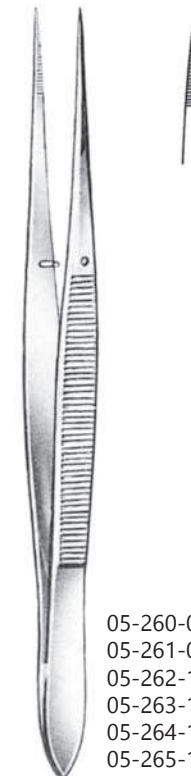

05-260-08 8 cm
05-261-09 9 cm
05-262-10 10.5 cm
05-263-11 11.5 cm
05-264-12 12.5 cm
05-265-14 14.5 cm



05-267-08 8 cm
05-268-09 9 cm
05-269-10 10.5 cm
05-270-11 11.5 cm
05-271-12 12.5 cm
05-272-14 14.5 cm



PEET
05-274-11
11.5 cm



RALK
05-276-15 - 05-277-15
15 cm

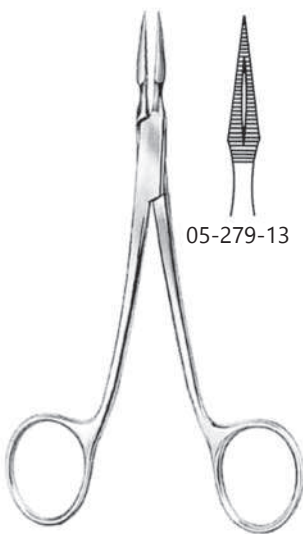
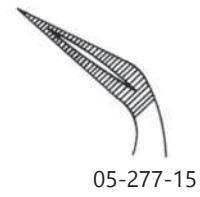
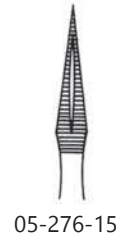

STIEGLITZ
05-279-13 - 05-280-13
13 cm

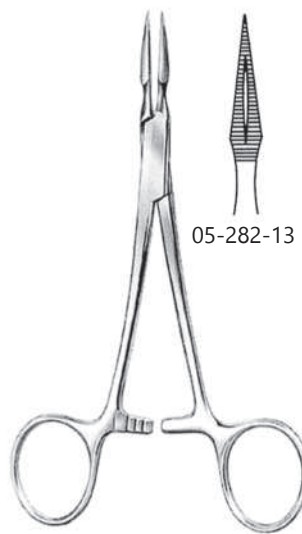

STIEGLITZ
05-282-13 - 05-283-13
13 cm

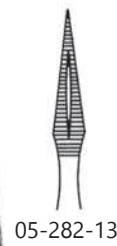



TAYLOR
05-285-17
17.5 cm



TAYLOR
05-287-17
17.5 cm

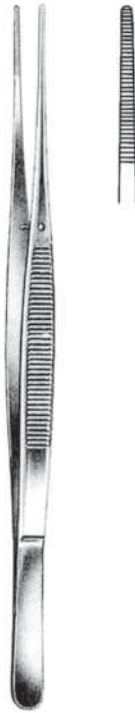

TAYLOR
05-289-17
17.5 cm



TAYLOR
05-291-17
17.5 cm



McINDOE
05-293-15
15 cm



TAYLOR
 05-295-17
 17.5 cm



TAYLOR
 05-297-17
 17.5 cm



TAYLOR
 05-299-17
 17.5 cm



TAYLOR
 05-301-17
 17.5 cm

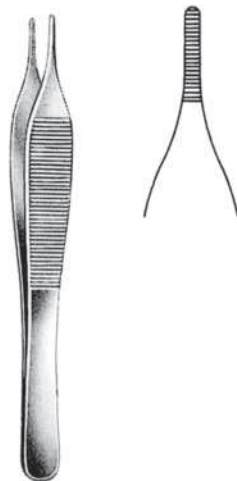

EWALD
 05-303-12
 12 cm

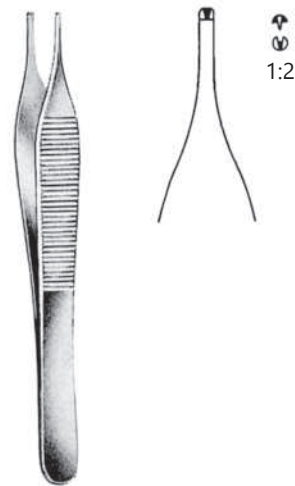

EWALD
 05-305-12
 12 cm

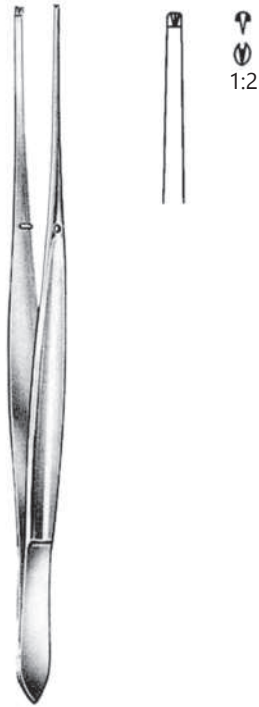

CUSHING
05-307-17
17.5 cm

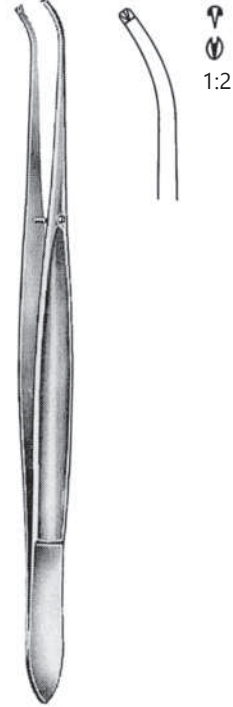

CUSHING
05-309-17
17.5 cm

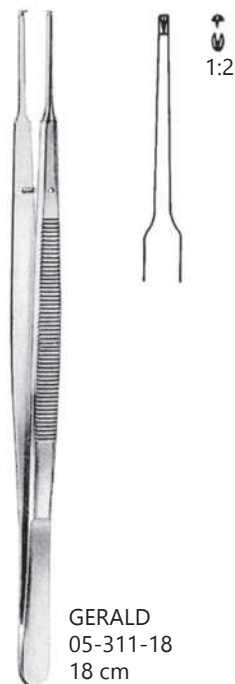

GERALD
05-311-18
18 cm

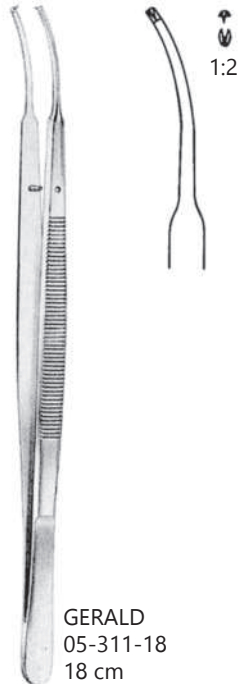

GERALD
05-311-18
18 cm



CUSHING
05-315-17
17.5 cm



CUSHING
05-317-17
17.5 cm

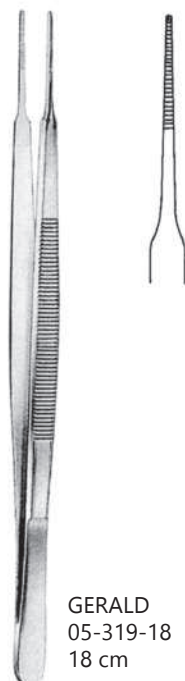

GERALD
05-319-18
18 cm



GERALD
05-321-18
18 cm



05-323-18 18 cm
05-324-21 21 cm
05-325-25 25cm

POTTS-SMITH
05-323-18 - 05-325-25



05-327-18 18 cm
05-328-21 21 cm
05-329-25 25cm

POTTS-SMITH
05-327-18 - 05-329-25



BROPHY
05-331-20
20 cm



BROPHY
05-333-20
20 cm



1:2

05-335-18 18 cm
05-336-21 21 cm
05-337-25 25 cm

POTTS-SMITH
05-335-18 - 05-337-25



1:2

05-339-18 18 cm
05-340-21 21 cm
05-341-25 25 cm

POTTS-SMITH
05-339-18 - 05-341-25

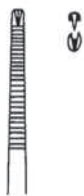

1:2

BROPHY
05-343-20
20 cm



1:2

BROPHY
05-345-20
20 cm



DUEHRSSEN
 05-347-20
 20 cm

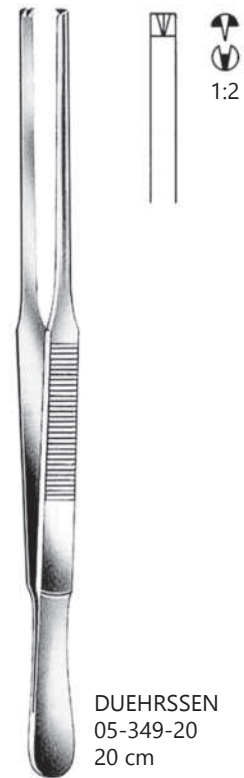

DUEHRSSEN
 05-349-20
 20 cm



DUEHRSSEN
 05-351-20
 20 cm



DUEHRSSEN
 05-353-20
 20 cm

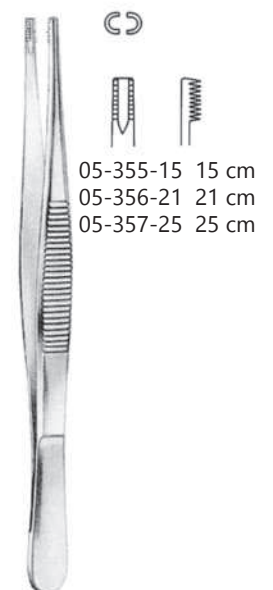

BROWN
 05-355-15 - 05-357-25

05-355-15 15 cm
 05-356-21 21 cm
 05-357-25 25 cm



05-359-11 11 cm
 05-360-13 13 cm
 05-361-15 15 cm

STILLE
 05-359-11 - 05-361-15

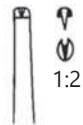

STILLE
 05-363-15
 15 cm

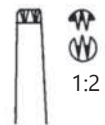

STILLE
 05-365-15
 15 cm



ADLERKREUTZ
 05-367-15 -05-368-20
 2:3 teeth

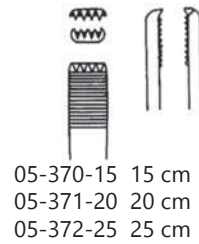

ADLERKREUTZ
 05-367-15 -05-368-20
 4:5 teeth

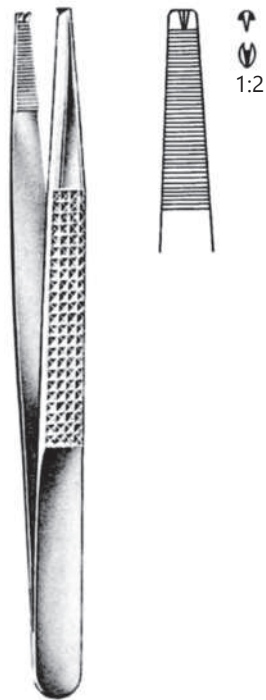

BONNEY
 05-374-18
 18 cm

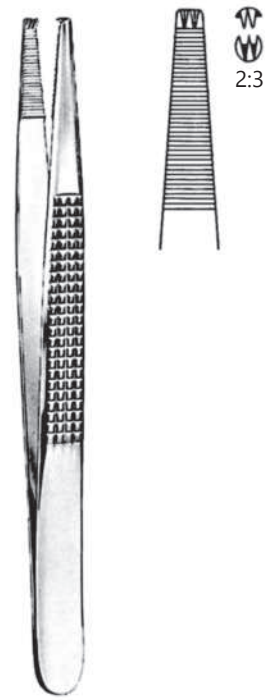

BONNEY
 05-376-18
 18 cm



MAYO-RUSS
 05-378-23
 23 cm



SINGLEY- TUTTLE
 05-380-23
 23 cm



05-382-20



05-383-20

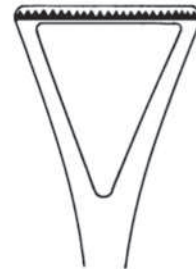

05-384-20

COLLIN-DUVAL
 05-382-20 - 05-384-20
 20 cm

05-386-10
 Fig-1



05-386-10 - 05-388-10
 10.5 cm

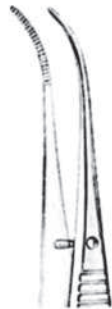

05-387-10
 Fig-2

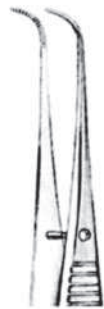

05-388-10
 Fig-3

05-390-10
 Fig-1



05-390-10 - 05-392-10
 10.5 cm
 1:2 teeth



05-391-10
 Fig-2



05-392-10
 Fig-3



WANGENSTEEN
 05-394-23
 23 cm



05-396-18 18 cm
 05-397-20 20 cm
 05-398-25 25 cm

STILLE-BARRAYA
 05-396-18 - 05-398-25
 3:4 teeth

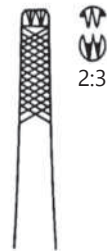

FERRIS-SMITH
 05-400-18
 18 cm

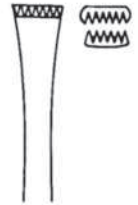

NELSON
 05-402-23
 23 cm

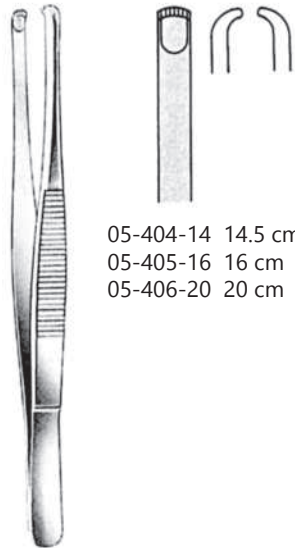

05-404-14 14.5 cm
05-405-16 16 cm
05-406-20 20 cm

DURANTE
05-404-14 - 05-406-20



DUVAL
05-408-14
14.5 cm

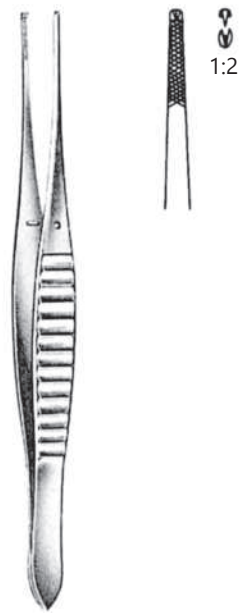

GILLIES
05-410-15
15 cm

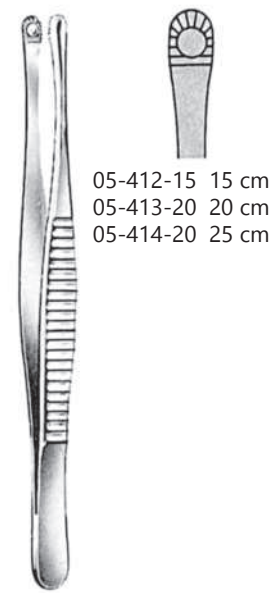

RUSS.MODELL
05-412-15 - 05-414-25

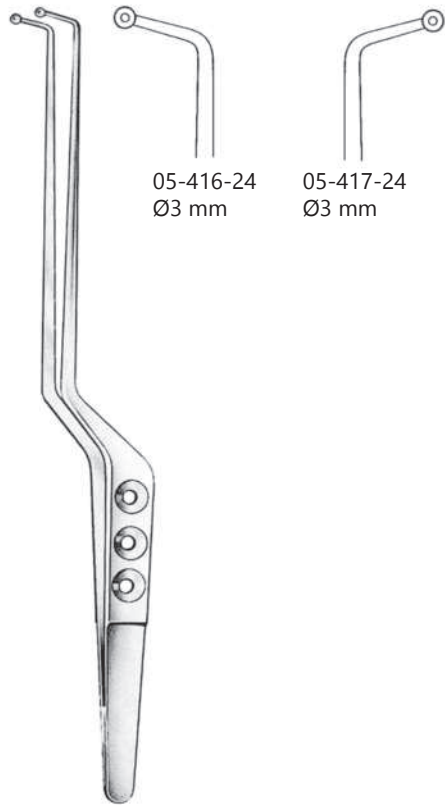

SAMII
05-416-24 - 05-417-24
24 cm

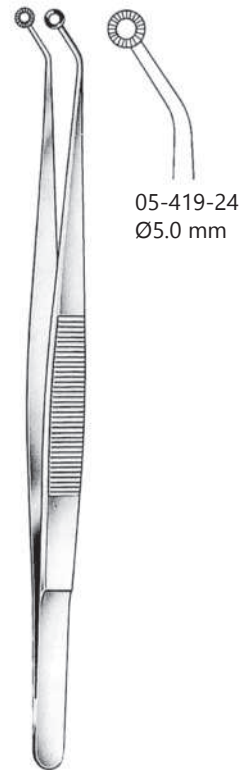

HUNT
05-419-20
20 cm

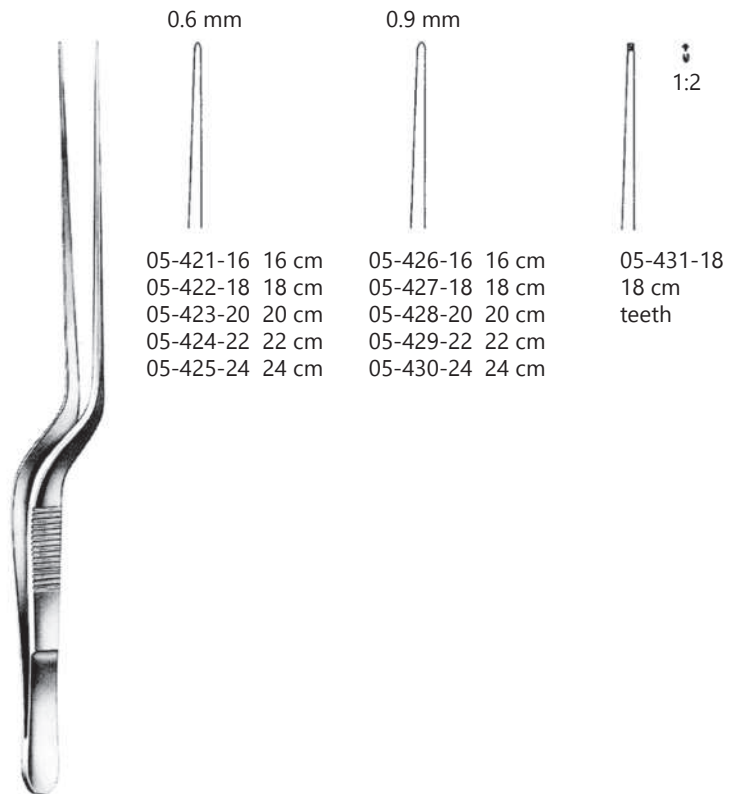

HUNT
05-421-16 - 05-431-18

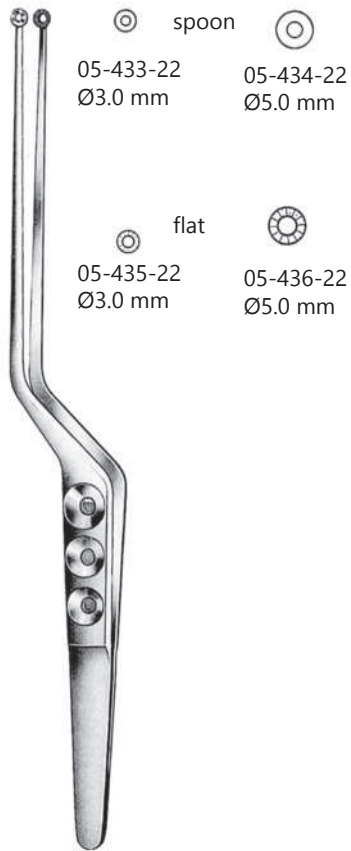

YASARGIL
05-433-22 - 05-436-22
22 cm



HEIFETZ
05-438-22 - 05-439-22
22 cm



05-441-11
11 cm



05-443-11
11 cm



05-445-12
12 cm



05-447-12
12 cm



05-449-12
12 cm



05-451-10
11.5 cm



05-453-10
10.5 cm



05-455-11
10.5 cm



05-457-11
11 cm

TC GOLD

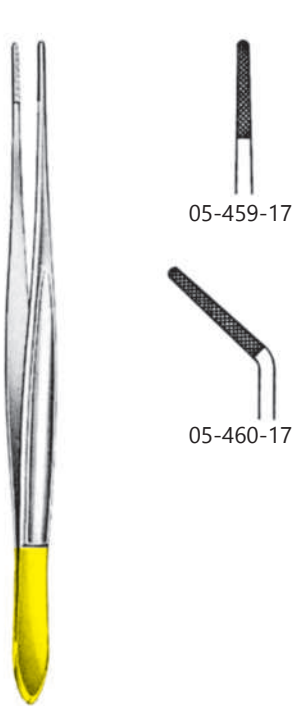

CUSHING
 05-459-17 - 05-460-17
 17.5 cm



CUSHING-TAYLOR
 05-462-18
 18 cm

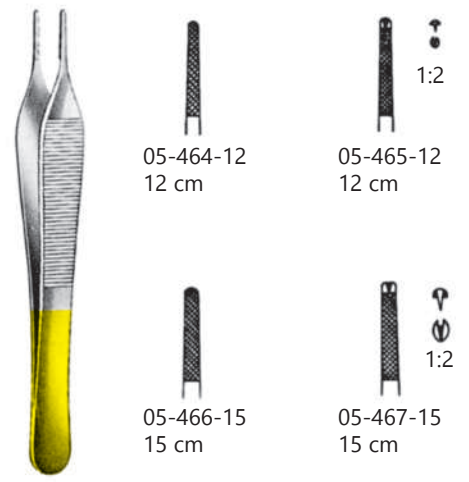

ADSON
 05-464-12 - 05-467-15

TC GOLD



GILLIES
 05-469-15
 15 cm



JEWELER
 05-471-15
 15 cm



SEMKEN
 05-473-12 - 05-474-15



DEHLER
 05-478-14 - 05-481-30
 17.5 cm

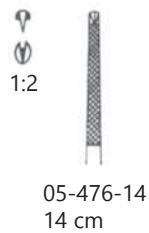

05-476-14
 14 cm

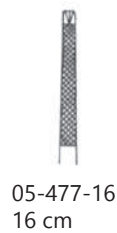

05-477-16
 16 cm

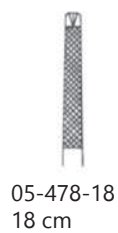

05-478-18
 18 cm



05-479-20
 20 cm



05-480-25
 25 cm



05-481-30
 25 cm



05-483-15 - 05-487-25



05-483-15
 15 cm



05-484-18
 18 cm



05-485-20
 20 cm



05-486-23
 23 cm



05-487-25
 25 cm



BONNEY
 05-489-18
 18 cm



WANGENSTEEN
 05-491-15 - 05-492-23

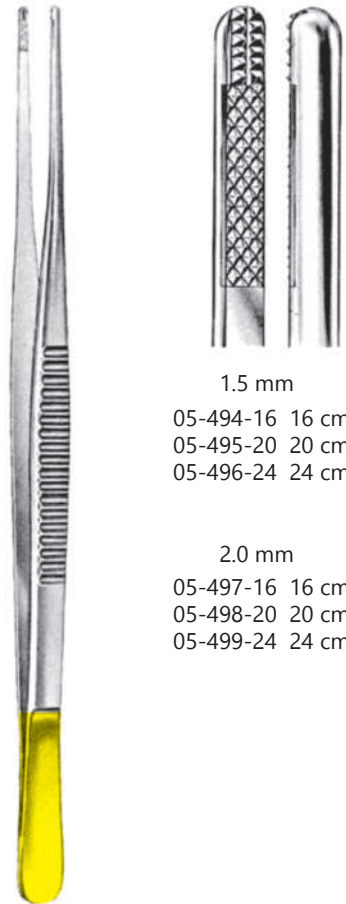

DE BAKEY
 05-494-16 - 05-499-24

- 1.5 mm
 - 05-494-16 16 cm
 - 05-495-20 20 cm
 - 05-496-24 24 cm
- 2.0 mm
 - 05-497-16 16 cm
 - 05-498-20 20 cm
 - 05-499-24 24 cm



06

Ophthalmology
Augenheilkunde
Oftalmología



ARRUGA
06-010-10
10 cm

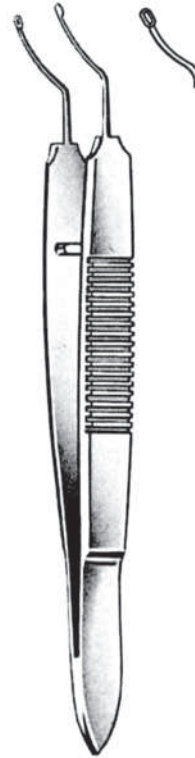

ARRUGA
06-012-10
10 cm

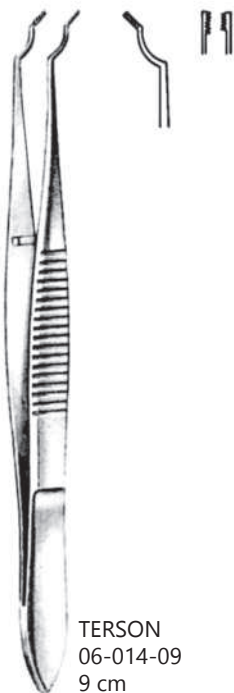

TERSON
06-014-09
9 cm



CASTROVIEJO
06-016-10
10 cm



CASTROVIEJO
06-018-10
10 cm



BINKHORST
06-020-07
7 cm



GILL-FUCHS
06-022-07
7.5 cm



MOD-BONN
06-024-07
1:2 teeth
7 cm



MOD-BONN
06-024-07
1:2 teeth
7 cm



BARRAQUER-KATZIN
(Colibri)
06-028-07
1:2 teeth
7 cm



TROUTMAN
(Corneal)
06-030-07
1:2 teeth
7 cm



BARRAQUER-KATZIN
(Colibri)
06-032-07
1:2 teeth
7.5 cm

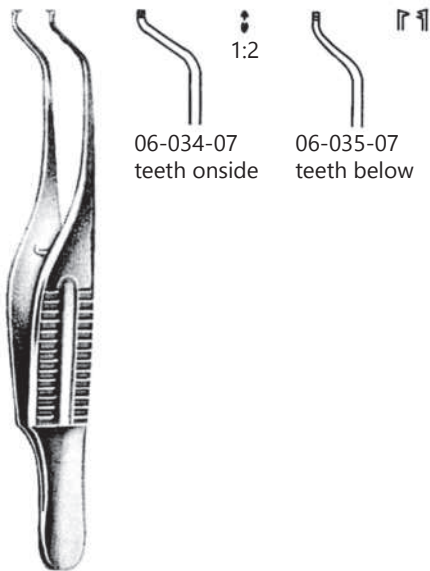

GILL-HESS
06-034-07 - 06-035-07
7.5 cm



HESS
06-037-07
7 cm

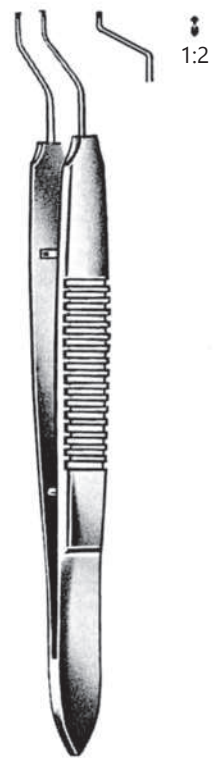

HESS
06-039-09
9 cm



GRAEFE
06-041-07 - 06-052-10

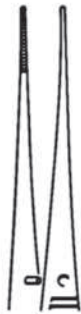

Fig-1

06-041-07 7 cm
06-042-10 10 cm



Fig-2

06-043-07 7 cm
06-044-10 10 cm



Fig-3

06-045-07 7 cm
06-046-10 10 cm

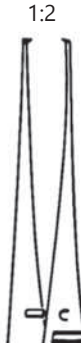

Fig-4

06-047-07 7 cm
06-048-10 10 cm



Fig-5

06-049-07 7 cm
06-050-10 10 cm



Fig-6

06-051-07 7 cm
06-052-10 10 cm



GRAEFE
06-054-05 - 06-056-10
7 cm



06-054-05 0.5 cm
06-055-07 0.7 cm
06-056-10 1.0 cm



GRAEFE
06-058-05 - 06-060-10
7 cm



GRAEFE
06-062-05 - 06-064-10
7 cm



06-062-05 0.5 cm
06-063-07 0.7 cm
06-064-10 1.0 cm

1:2



GRAEFE
06-066-05 - 06-068-10
7 cm



06-066-05 0.5 cm
06-067-07 0.7 cm
06-068-10 1.0 cm

1:2



STEVENS
06-070-10 - 06-075-10
10.5 cm



06-070-10
Fig-1



06-071-10
Fig-2



06-072-10
Fig-3



06-073-10
Fig-1

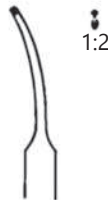

06-074-10
Fig-2

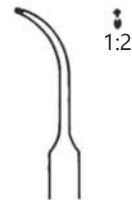

06-075-10
Fig-3

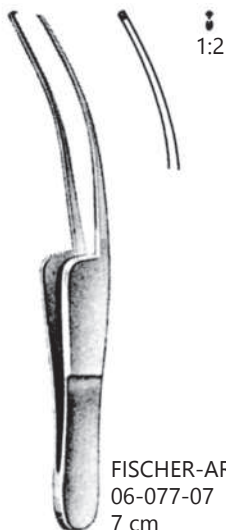

FISCHER-ARLT
06-077-07
7 cm

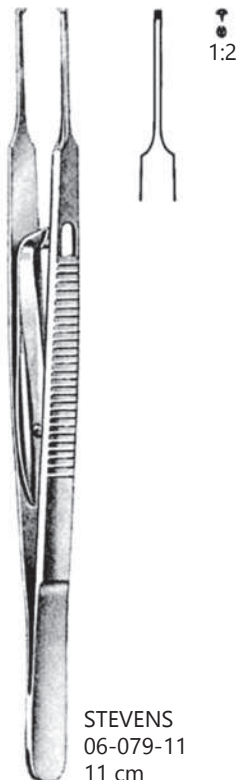

STEVENS
06-079-11
11 cm

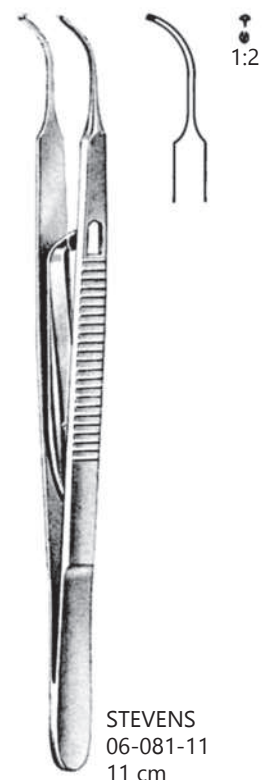

STEVENS
06-081-11
11 cm



BISHOP-HARMAN
06-083-08
8.5 cm



BISHOP-HARMAN
06-085-08
8.5 cm



BISHOP-HARMAN
06-087-08
8.5 cm



BISHOP-HARMAN
06-089-08
1:2 teeth
8.5 cm



KIRBY
06-091-09
1:2 teeth
9 cm



FOERSTER
06-093-08
8.5 cm



FOERSTER
06-093-08
8.5 cm



FOERSTER
06-097-08
8.5 cm



FOERSTER
06-099-08
8.5 cm



ST.MARTIN
06-101-07
7 cm



DESMARRES
06-103-09
9 cm



06-103-09
Fig-1

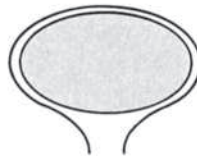

06-104-09
Fig-2



06-105-09
Fig-3



AYER
06-107-09
9 cm



AYER
06-109-09
9 cm

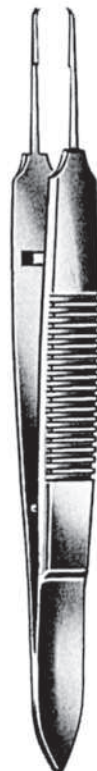

- 06-111-10 0.12 mm
- 06-112-10 0.30 mm
- 06-113-10 0.50 mm
- 06-114-10 1.0 mm
- 06-115-10 1.5 mm

CASTROVIEJO
06-111-10 - 06-115-10
10 cm



- 06-117-10 0.12 mm
- 06-118-10 0.30 mm
- 06-119-10 0.50 mm
- 06-120-10 1.0 mm
- 06-121-10 1.5 mm

CASTROVIEJO
06-117-10 - 06-121-10
10 cm

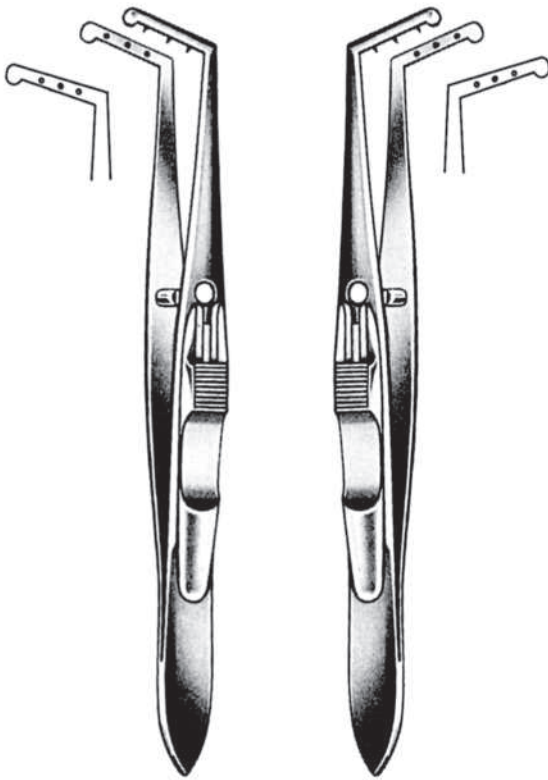

SATTLER
 06-123-10
 10 cm

SATTLER
 06-125-10
 10 cm

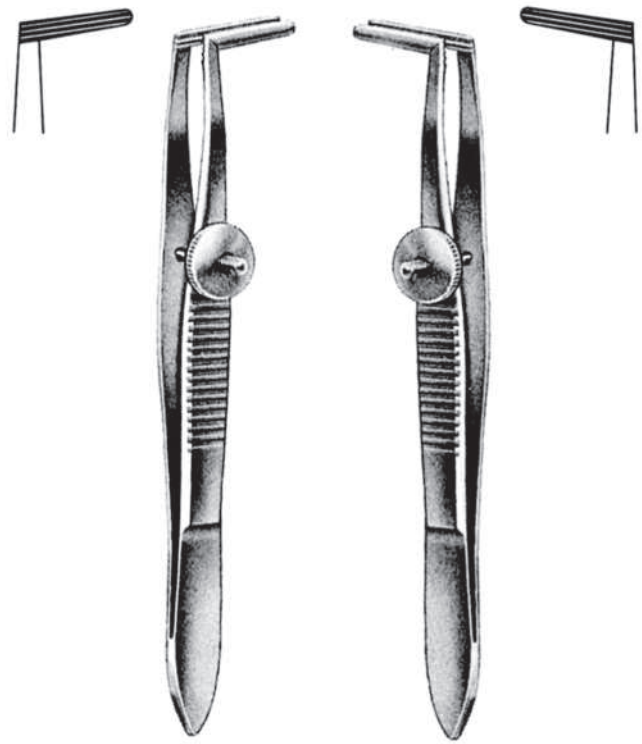

BLASCOVICS
 06-127-09
 9 cm

BLASCOVICS
 06-129-09
 9 cm



BONACCOLTO
06-131-10
10 cm



BONACCOLTO
06-133-10
10 cm

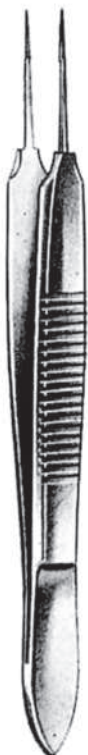

MOD-TUBINGEN
06-135-10
10 cm

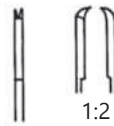
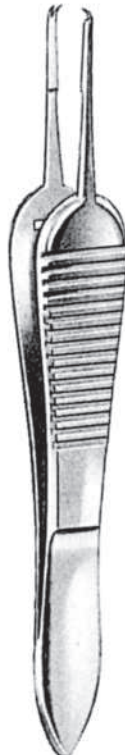

PAUFIQUE
06-137-10
10 cm



ERHARDT
06-139-09
9 cm

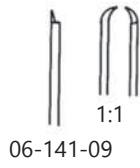

CASTROVIEJO
 06-141-09 - 06-142-09
 9 cm



LESTER
 06-144-09 - 06-145-09
 9 cm



MOORFIELD
 06-147-10
 10 cm

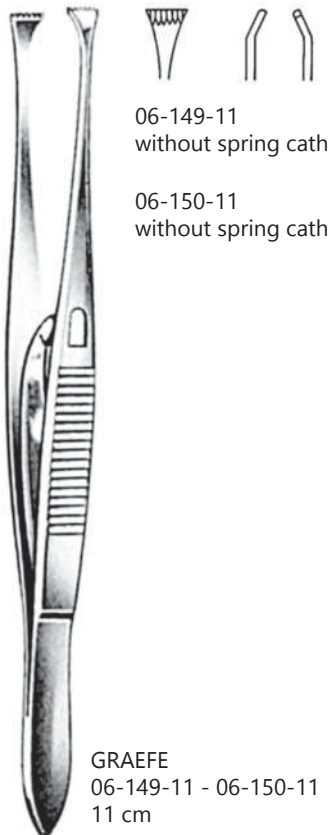

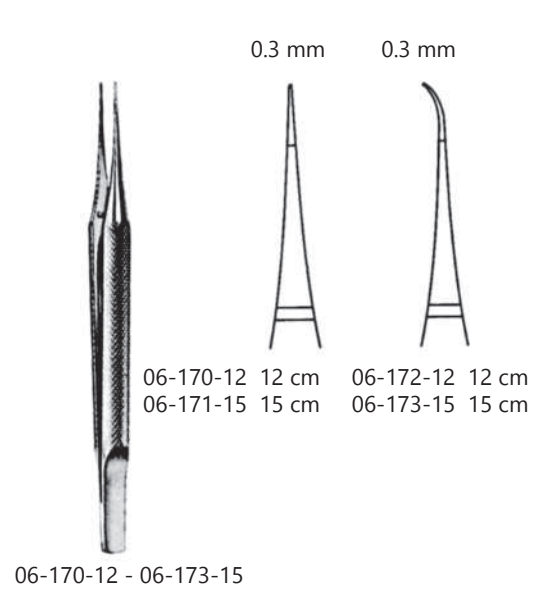
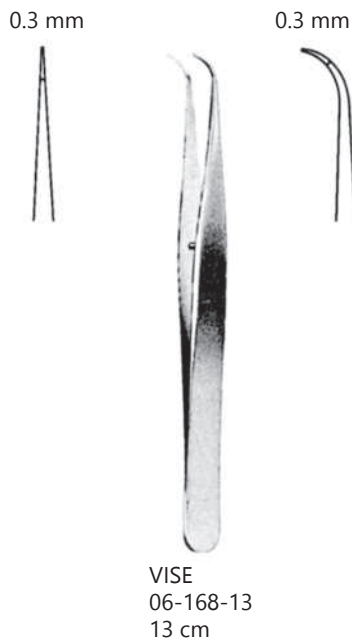
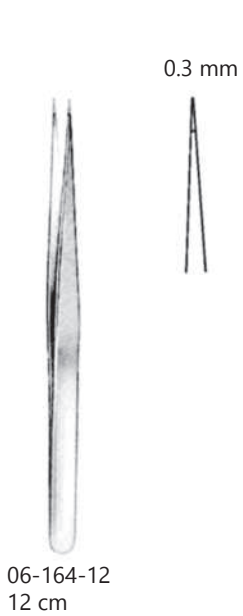
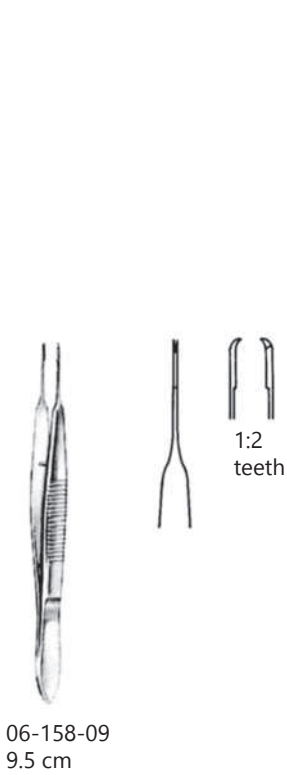



06-175-11
11 cm



06-177-14
14 cm



06-179-14
14 cm



06-181-14
14 cm



06-183-18



06-184-18

06-183-18 - 06-184-18
18 cm

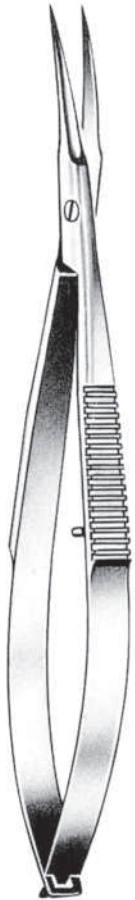

WESTCOTT
06-186-12
12 cm
curved



WESTCOTT
06-188-11
11.5 cm
straight

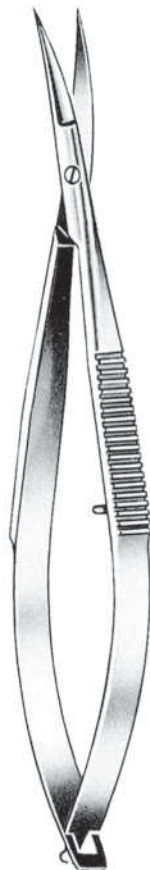

WESTCOTT
06-190-11
11.5 cm
curved



NOYES
06-192-15
15 cm

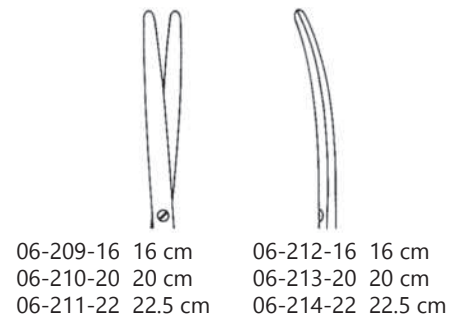
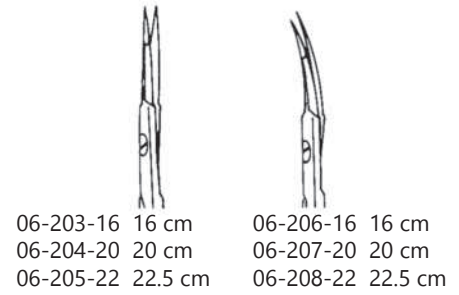
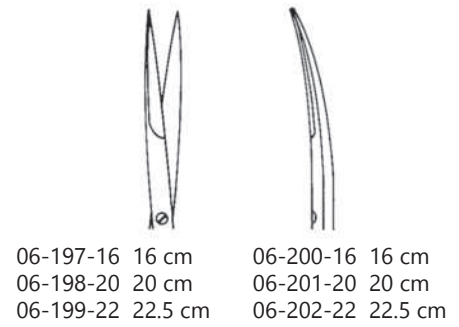
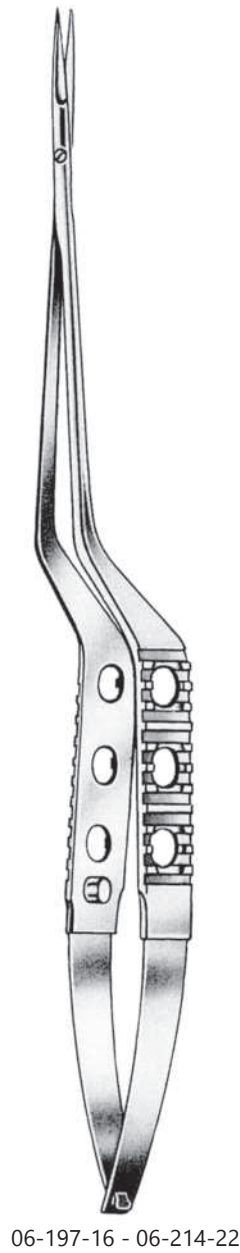
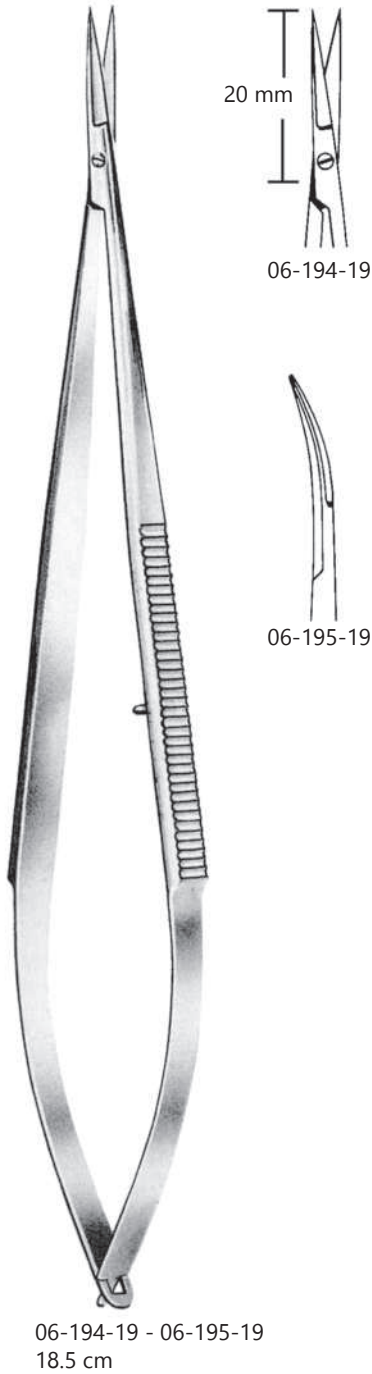



06-216-18 - 06-219-18
18 cm



06-216-18
25°



06-217-18
45°



06-218-18
60°



06-219-18
90°



06-221-18 - 06-224-18
18 cm



06-221-18
25°



06-222-18
45°



06-223-18
60°



06-224-18
90°

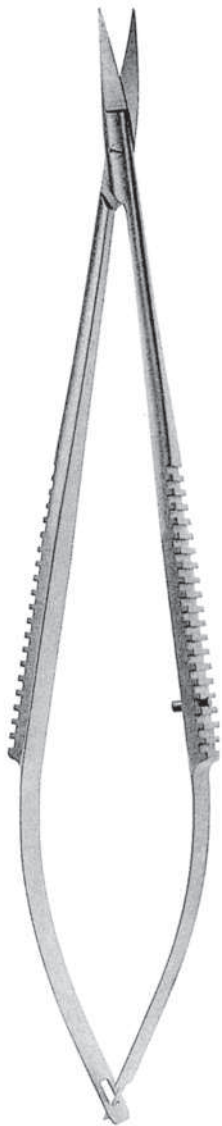

06-226-15 - 06-231-15
15 cm

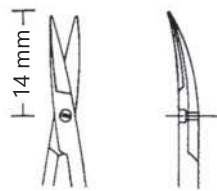

06-227-15
dissection

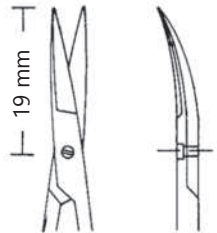

06-229-15
dissection

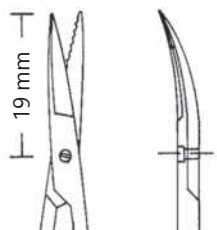
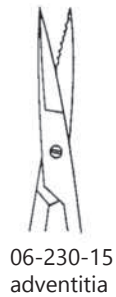

06-231-15
dissection

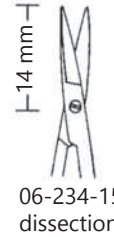
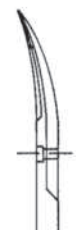
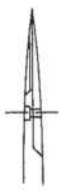
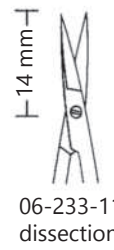
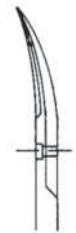

06-233-11 - 06-234-11
11 cm

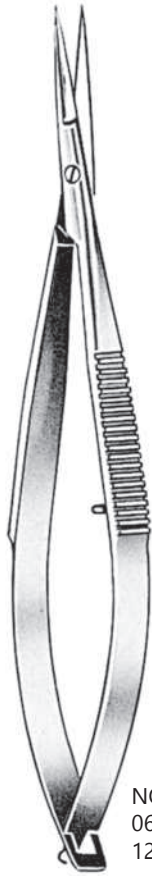

NOYES
06-236-12 - 06-238-12
12 cm

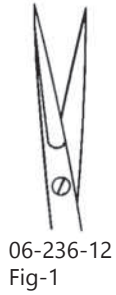

06-236-12
Fig-1

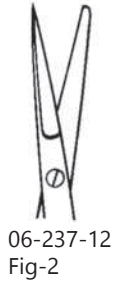

06-237-12
Fig-2

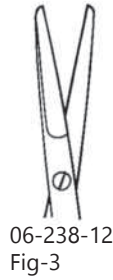

06-238-12
Fig-3



NOYES
06-240-12 - 06-242-12
12 cm

06-240-12 Fig-1
06-241-12 Fig-2
06-242-12 Fig-3
angle

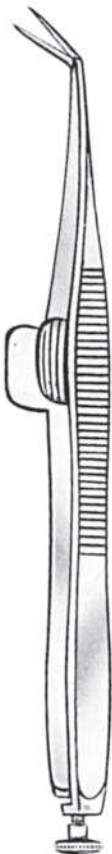

WECKER
06-244-11 - 06-246-11
11 cm



06-244-11
Fig-1



06-245-11
Fig-2



06-246-11
Fig-3



BARRAQUER
06-248-05 5 mm
06-249-07 7 mm
06-250-10 10 mm

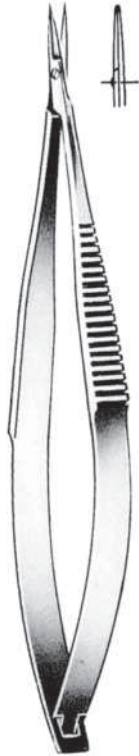

06-252-10
10 cm

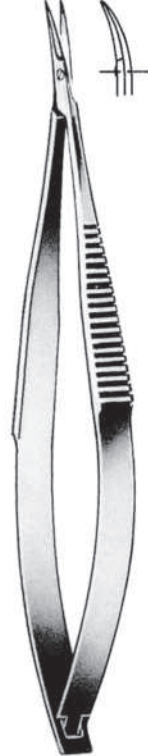

06-254-10
10 cm

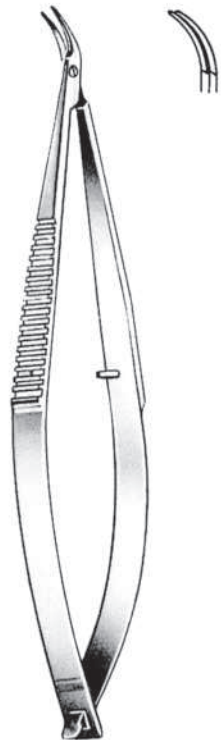

KATZIN
06-256-10
11 cm

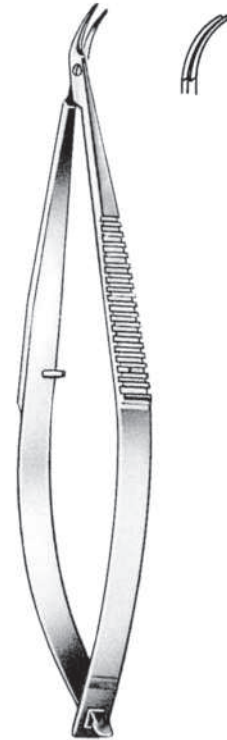

KATZIN
06-258-11
11 cm

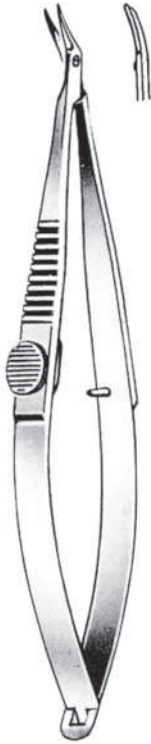

KATZIN-BARRAQUER
06-260-10
10 cm

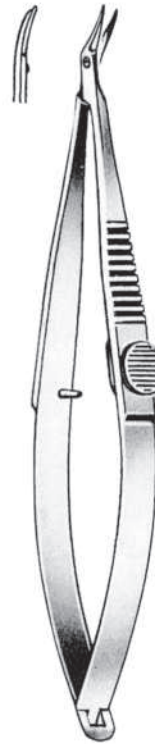

KATZIN-BARRAQUER
06-262-10
10 cm

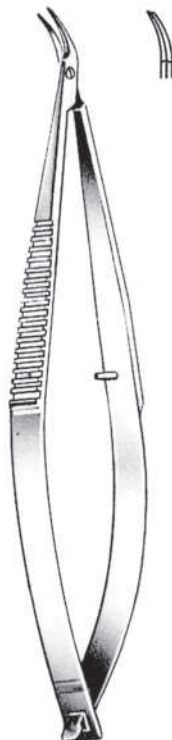

KATZIN
06-264-10
10 cm

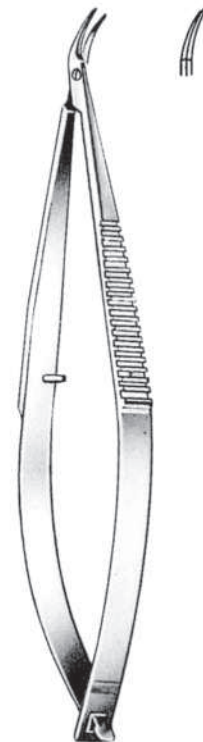

KATZIN
06-266-10
10 cm



06-268-14 - 06-269-14
14.5 cm

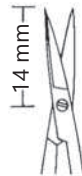

06-268-15



06-269-15

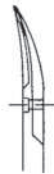

06-271-18 - 06-272-18
18 cm



06-271-18



06-272-18





06-274-14
14.5 cm



06-276-18
18 cm



06-278-18
18 cm



IRIS - FLAT
STRAIGHT
06-280-11
11.5 cm



IRIS - FLAT
CURVED
06-282-11
11.5 cm

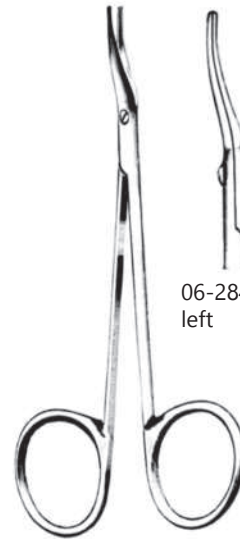

MC GUIRE
06-284-09 - 06-285-09
9.5 cm



06-284-09
left



06-285-09
right



La Garange
06-287-11 - 06-288-11
11.5 cm



06-287-10



06-288-10
serrated



Landolt
06-290-12 - 06-291-12
12 cm



06-290-12



06-291-12

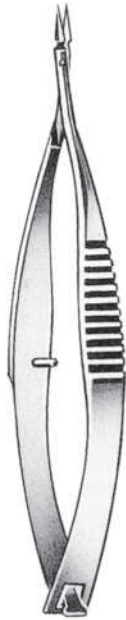

VANNAS
 06-293-08
 8 cm
 straight

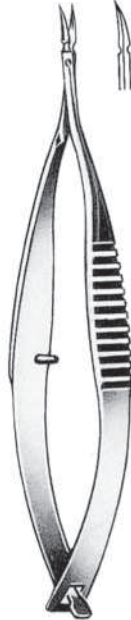

VANNAS
 06-295-08
 8 cm
 curved

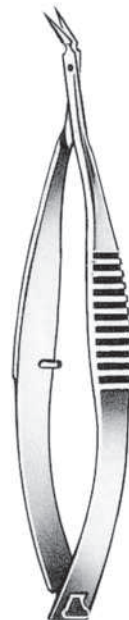

VANNAS
 06-297-08
 8 cm
 angular

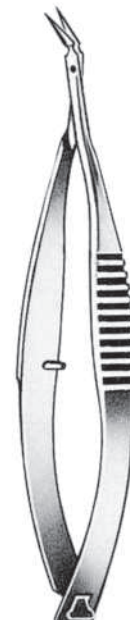

VANNAS
 06-299-08
 8 cm
 angled on flat

VANNAS, SPECIAL MODEL

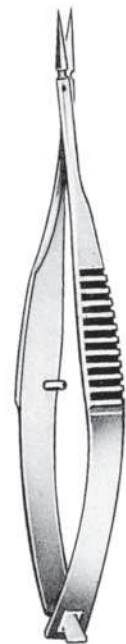

06-301-08
 8.5 cm
 straight

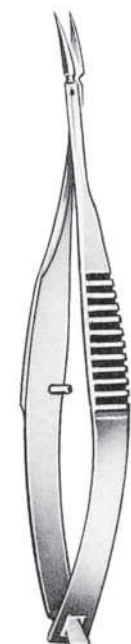

06-303-08
 8.5 cm
 curved

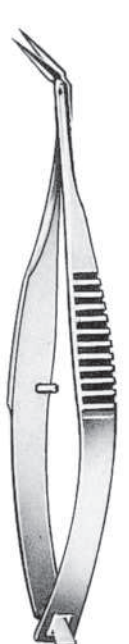

06-305-08
 8.5 cm
 angular

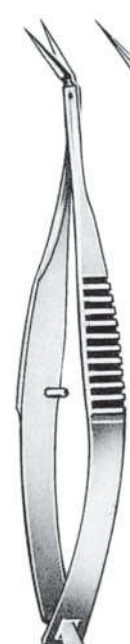

06-307-08
 8.5 cm
 angular

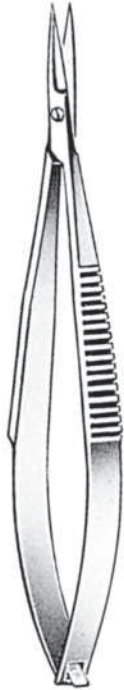

CASTROVIEJO
06-309-09 - 06-312-09
9 cm



06-309-09
blunt

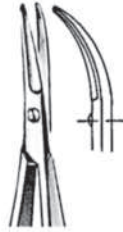

06-310-09
blunt



06-311-09
blunt



06-312-09
sharp

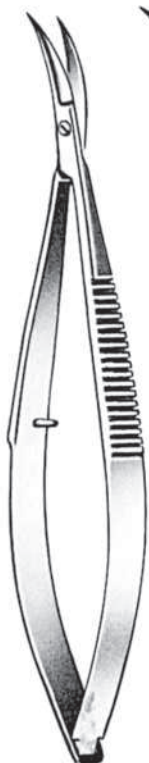

CASTROVIEJO
06-314-10
10 cm



sharp

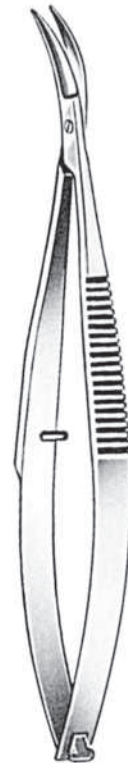

CASTROVIEJO
06-316-10
10 cm



blunt

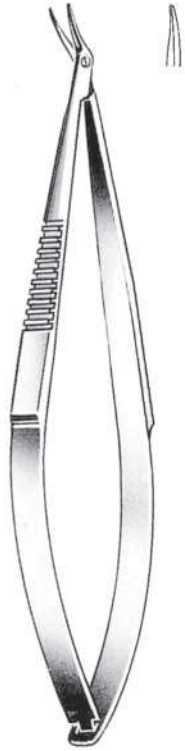

TROUTMAN
 06-318-10
 10 cm

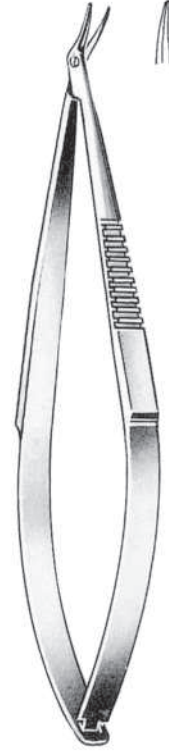

TROUTMAN
 06-320-10
 10 cm

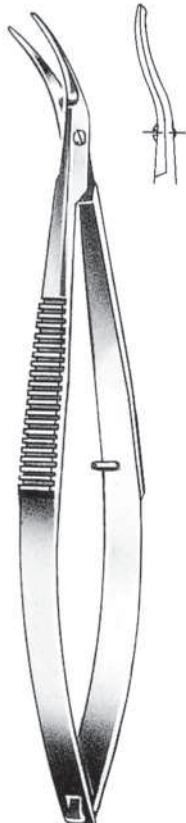

CASTROVIEJO
 06-322-11
 11 cm

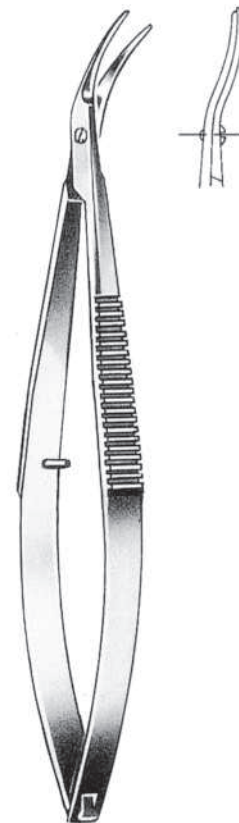

CASTROVIEJO
 06-324-11
 11 cm



06-326-10 - 06-331-15



CASTROVIEJO
06-326-10
10 cm



CASTROVIEJO
06-327-10
10 cm



CASTROVIEJO
06-328-15
15 cm



ANEL
06-329-00



ANEL
06-330-00



ANEL
06-331-00



HRSCHMANN
06-333-14
14 mm



JAFFE
06-334-14
14 mm



KWITKO
06-335-14
14 mm



BANGERTER
06-336-14
14 mm

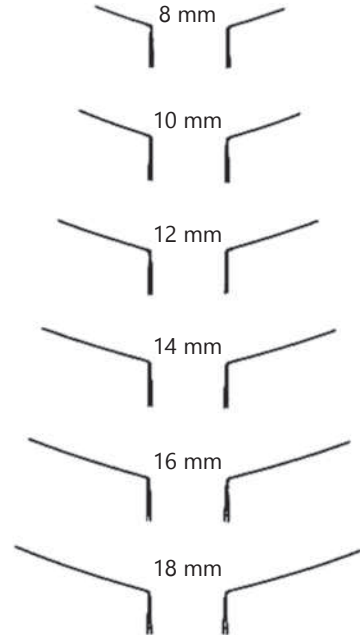

CASTROVIEJO - BARRAQUER

- | | |
|-----------------|-----------------|
| 06-338-08 8 mm | 06-344-08 8 mm |
| 06-339-10 10 mm | 06-345-10 10 mm |
| 06-340-12 12 mm | 06-346-12 12 mm |
| 06-341-14 14 mm | 06-347-14 14 mm |
| 06-342-16 16 mm | 06-348-16 16 mm |
| 06-343-18 18 mm | 06-349-18 18 mm |



MEYHOEFER
06-351-00

3.7 x 2.7 mm
spoon



WELLS
06-353-00



CASTROVIEJO
06-355-00



CASTROVIEJO
06-357-01 0.5X 15 mm
06-358-02 0.75x 15 mm
06-359-03 1.0x 15 mm



WECKER
06-361-02



WECKER
(Wheeler)
06-362-11
1 mm



SAUTTER
06-364-12
12 mm



SAUTTER
06-365-15
15 mm



SAUTTER
06-366-17
17 mm



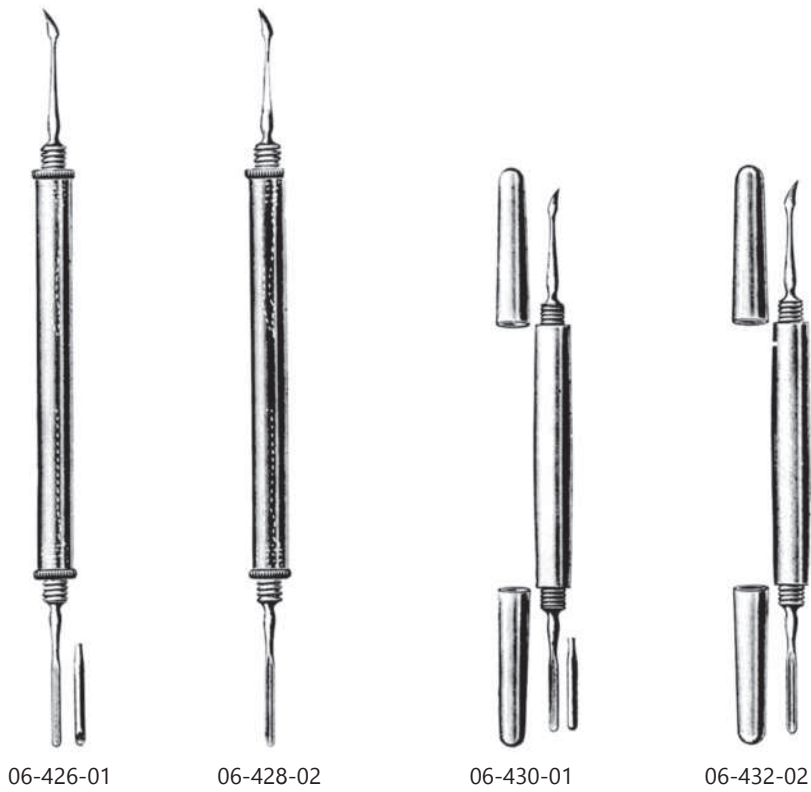
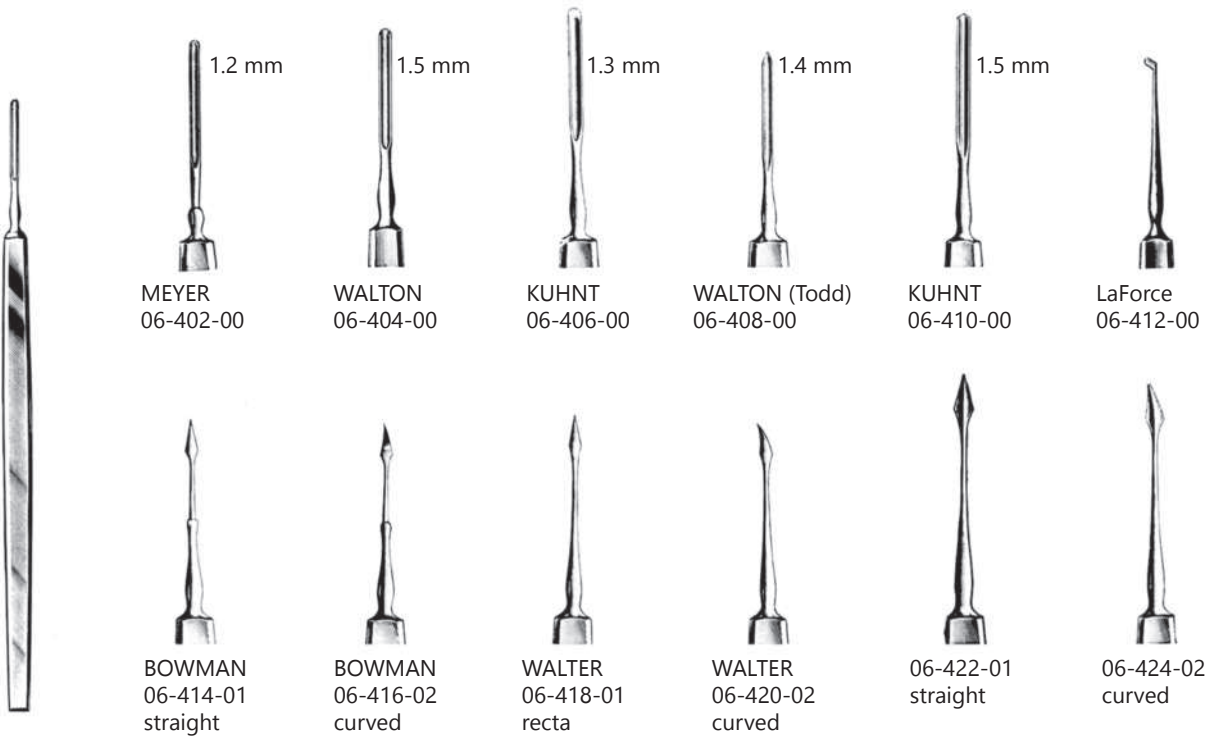



WEBER
06-434-01
Fig-1



WEBER
06-436-02
Fig-2



WEBER
06-438-03
Fig-3



GRAEFE
06-440-00



KUHNT
06-448-01
Fig-1



KUHNT
06-450-02
Fig-2



KUHNT
06-452-03
Fig-3



KUHNT
06-454-04
Fig-4



PAUFIQUE
06-456-00



ROLLET
06-458-00



TOOKE
06-460-00



BARRAQUER
06-462-00
7 X 1 mm



GILL
06-464-00
curved



BARRAQUER
06-466-00



BARRAQUER
06-468-03 3 cm
06-470-04 4 cm



BOWMAN
06-472-07
7 cm

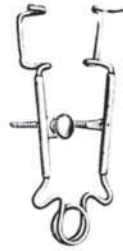

CRITCHETT
06-474-07
7 cm



GRAEFE
06-476-07 7 cm
06-478-09 9 cm



MULLER
06-480-07
7 cm



WEISS
06-482-08
8 cm



WEISS
06-484-07 7 cm
06-486-09 9 cm



WEISS
06-488-07 7 cm
06-490-09 9 cm



WILIAMS
06-492-07 7 cm
06-494-08 9 cm



CASTROVIEJO
06-496-08
8 cm



SAUER
06-498-03
3 cm



LANCASTER
06-500-07
7 cm

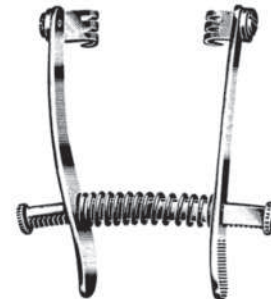

AXENFEILD
06-502-08
8 cm



MURDOCK
06-504-05
5 cm



PLEY
06-506-06
6 cm



ZIEGLER
06-508-06
7 cm

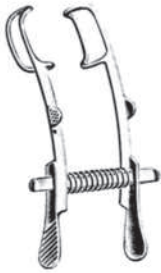

MELINGER
06-510-05 5cm
06-512-07 7 cm



MELINGER-BEARD
06-514-05 5cm
06-516-07 7 cm



MELINGER-AXENFELD
06-518-07
7 cm

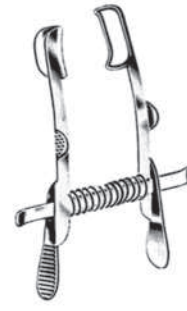

MELINGER-AXENFELD
06-520-07
7 cm

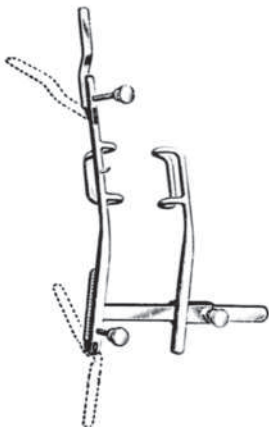

ARRUGA
06-522-07
7 cm

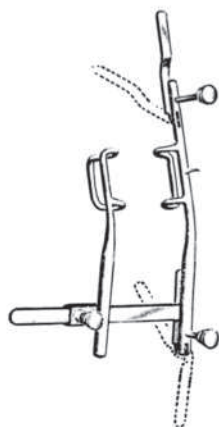

ARRUGA
06-524-07
7 cm



GUYTON-PARK
06-526-08
8 cm



PARK-MAUMENE
06-528-08
8 cm



DESMARRES
13 cm



06-530-01
10 cm
Fig-1



06-532-02
12 cm
Fig-2



06-534-03
14 cm
Fig-3



06-536-04
16 cm
Fig-4



06-538-05
18 cm
Fig-5



CALEZOWSKY

- 06-542-00 Fig-000 0.6 mm
- 06-543-00 Fig-00 0.7 mm
- 06-544-00 Fig-0 0.8 mm
- 06-545-01 Fig-1 0.9 mm
- 06-546-02 Fig-2 1.1 mm
- 06-547-03 Fig-4 1.3 mm
- 06-548-04 Fig-5 1.4 mm
- 06-549-05 Fig-5 1.5 mm
- 06-550-06 Fig-6 1.6 mm



BOWMAN

- 06-552-00 Fig-0000 0.5 mm
- 06-553-00 Fig-000 0.6 mm
- 06-554-00 Fig-00 0.7 mm
- 06-555-00 Fig-0 0.8 mm
- 06-556-01 Fig-1 0.9 mm
- 06-557-02 Fig-2 1.1 mm
- 06-558-03 Fig-3 1.3 mm
- 06-559-04 Fig-4 1.4 mm
- 06-560-05 Fig-5 1.5 mm
- 06-561-06 Fig-6 1.6 mm
- 06-562-07 Fig-7 1.8 mm
- 06-563-08 Fig-8 1.9 mm



BOWMAN (Williams)

- 06-565-00 Fig-00 0.7 mm
- 06-566-00 Fig-0 0.8 mm
- 06-567-00 Fig-1 0.9 mm
- 06-568-00 Fig-2 1.1 mm
- 06-569-01 Fig-3 1.3 mm
- 06-570-02 Fig-4 1.4 mm
- 06-571-03 Fig-5 1.5 mm
- 06-572-04 Fig-6 1.6 mm
- 06-573-05 Fig-7 1.8 mm
- 06-574-06 Fig-8 1.9 mm



BOWMAN

- 06-575-00 Fig-00 0.7 mm
- 06-576-00 Fig-0 0.8 mm
- 06-577-00 Fig-1 0.9 mm
- 06-578-00 Fig-2 1.1 mm
- 06-579-01 Fig-3 1.3 mm
- 06-580-02 Fig-4 1.4 mm
- 06-581-03 Fig-5 1.5 mm
- 06-582-04 Fig-6 1.6 mm
- 06-583-05 Fig-7 1.8 mm
- 06-584-06 Fig-8 1.9 mm



BOWMAN
06-586-00
set of lacrimal channel sondes in behalter



ROLF
06-588-00



CASTROVIEJO
06-590-00



ZIEGIER
06-592-00



MEYHOEFER
06-549-10
1.5 mm Ø



MEYHOEFER
06-546-11
2.0 mm Ø



MEYHOEFER
06-598-12
2.5 mm Ø



MEYHOEFER
06-600-13
3.5 mm Ø



MEYHOEFER
06-602-14
4.0 mm Ø



SNELLEN
06-604-15
smooth



SNELLEN
06-608-10
serrated



WEBER
06-610-21
smooth



NEW ORLEANS
06-612-21
smooth



LEWIS
06-614-27
serrated



LEWIS
06-616-28
smooth



SKEELE
06-618-10
1.0 mm Ø



SKEELE
06-620-32
1.5 mm Ø



SKEELE
06-622-33
2.0 mm Ø



06-624-01
Fig-1



06-626-02
Fig-2



06-628-03
Fig-3



GRAEFE
06-630-00



DAVIEL
06-632-00
3.0 mm



DAVIEL
06-634-00
4.0 mm



ZEIGLER
06-636-01
5 mm



ZEIGLER
06-638-02
6 mm



ZEIGLER
06-640-03
7 mm



KNAPP
06-642-06
6 mm



KNAPP
06-644-07
7 mm



KNAPP
06-646-08
8 mm



WHEELER
06-648-00



GALEZOWSKY
06-650-00



GRAEFE
06-652-00



BARKAN
06-654-00



GRAEFE
06-656-00



GRAEFE
06-658-00



06-660-00
1.3 x 23 mm
Fig-0



06-662-01
1.5 x 25 mm
Fig-1



06-664-02
1.7 x 27 mm
Fig-2



06-666-03
2.0 x 30 mm
Fig-3



GRAEFE
06-668-04
2.3 x 33 mm
Fig-4



GRAEFE
06-670-05
2.5 x 35 mm
Fig-5

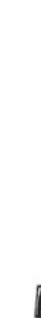

GRAEFE
06-672-06
3.0 x 32 mm
Fig-6



DEUTSCHMANN
06-674-00

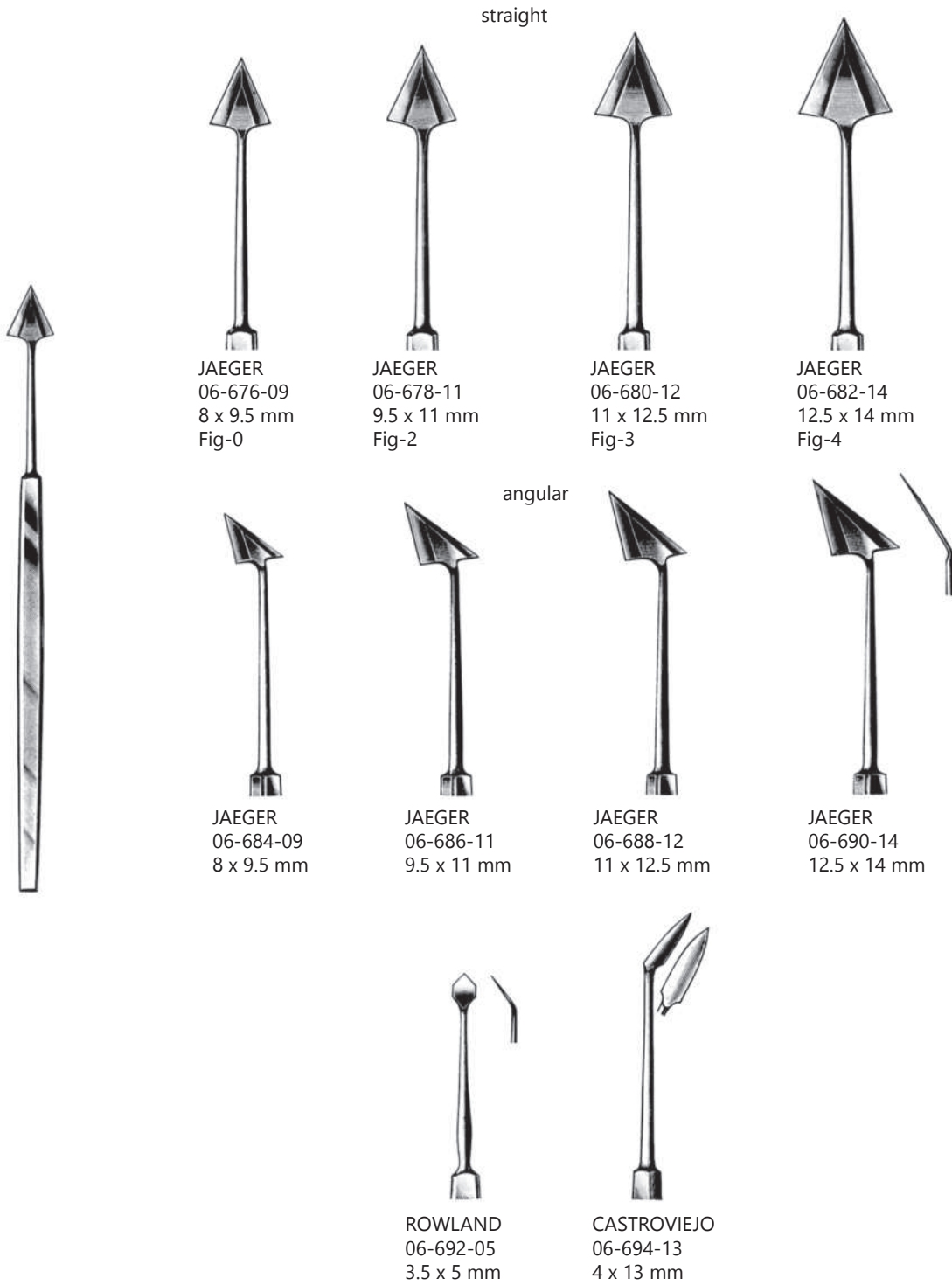



07

Suture
Naht
Sutura

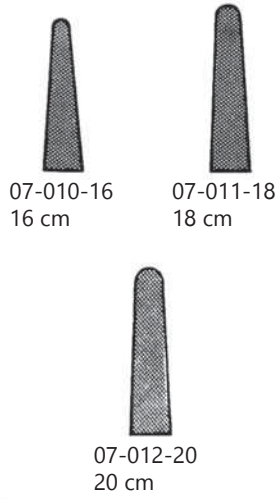

LANGENBECK
07-010-16 - 07-012-20



TOENNIS
07-014-18
18 cm



HOSEL
07-016-25
25 cm



ZAWEIFEL
07-018-20 - 07-019-23



CRILE
07-021-15
15 cm

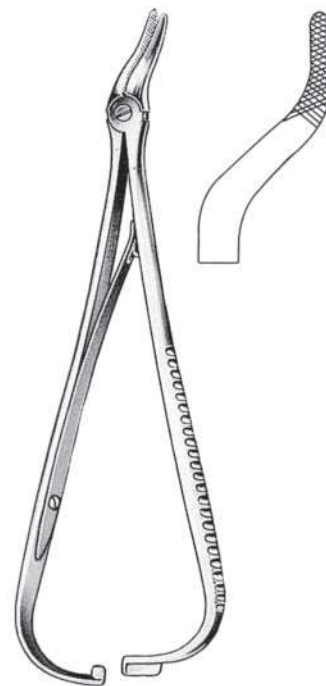

EISELSBERG-MATHIEU
07-023-18
18.5 cm

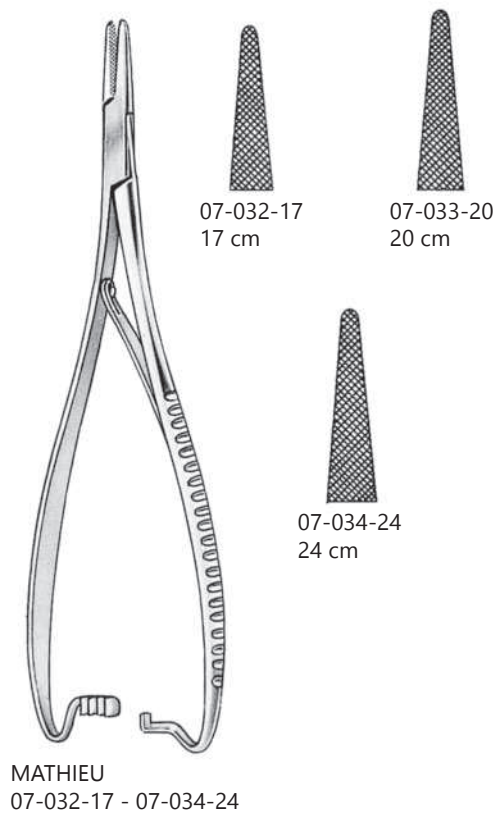
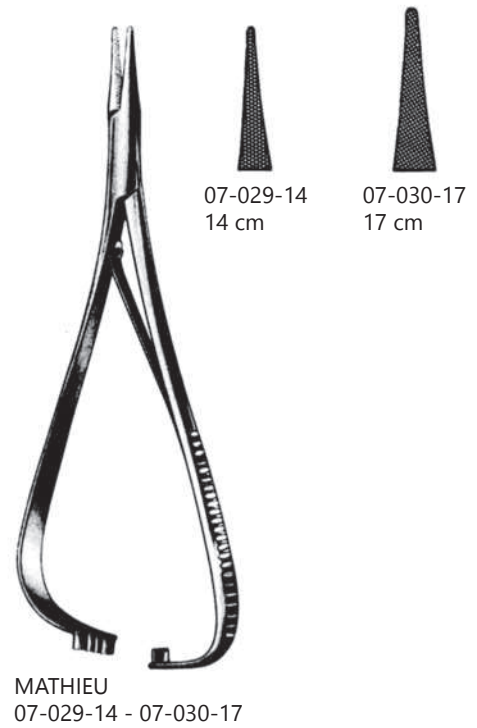
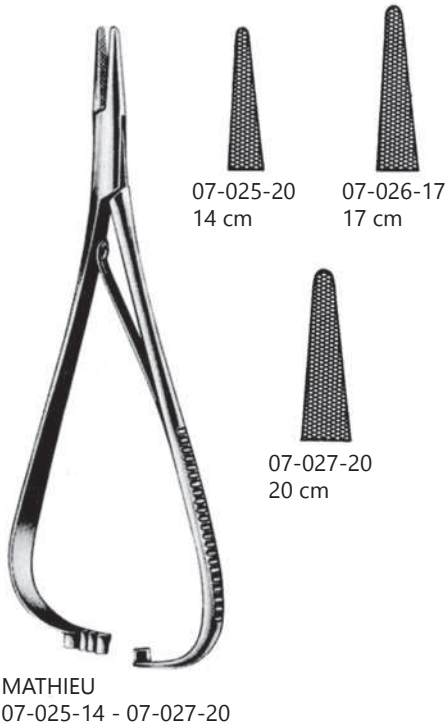

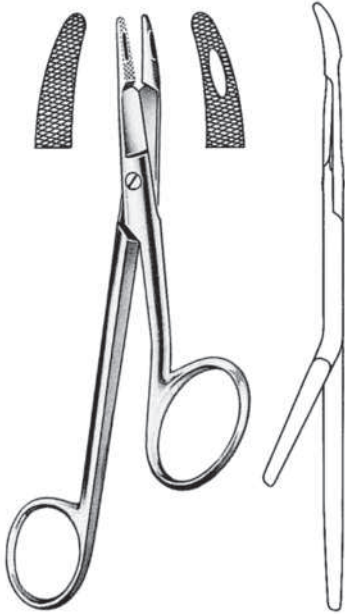

GILLIES
07-036-16
16 cm



WERTHEIM
07-038-20 20 cm
07-039-24 24 cm



WANGENSTEEN
07-041-27
27 cm

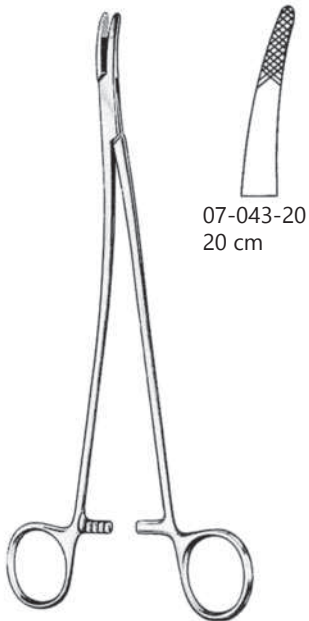

FINOCCHIETTO
07-043-20 - 07-044-23

07-043-20
20 cm

07-044-23
23 cm



FINOCCHIETTO
07-046-27
27 cm

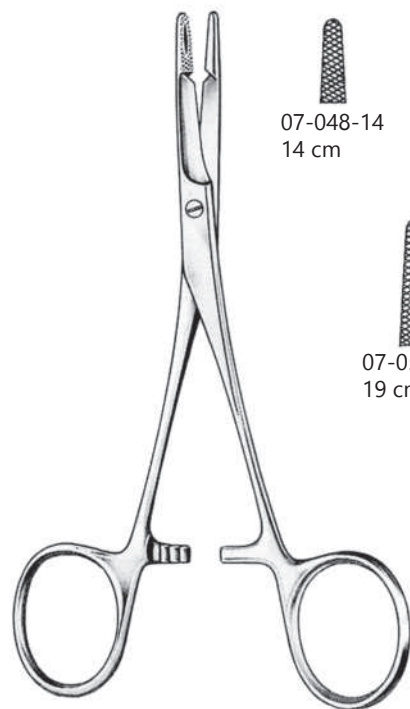

OLSEN-HEGAR
07-048-14 - 07-050-19

07-048-14
14 cm

07-049-17
17 cm

07-050-19
19 cm



JAMESON
07-052-23
23.5 cm



HEANEY
07-054-21
21 cm



MASSON
07-056-27
27 cm

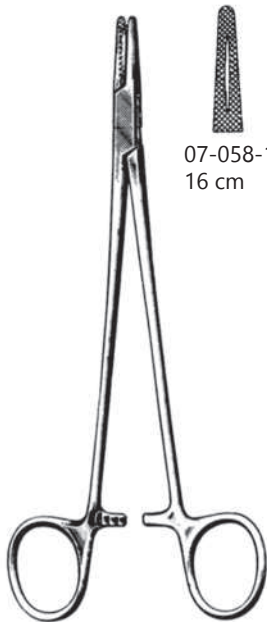

MAYO-HEGAR
07-058-16 - 07-060-20



07-058-16
16 cm



07-059-18
18 cm



07-060-20
20 cm

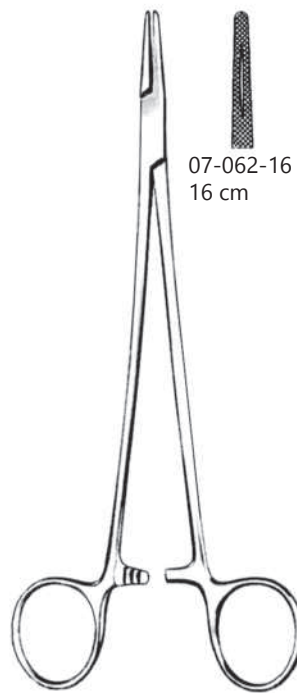

MAYO-HEGAR-GRAZIL
07-062-16 - 07-064-20

delicate



07-062-16
16 cm



07-063-18
18 cm



07-064-20
20 cm



DERF
07-066-12
12 cm



COLLIER
07-068-12
12.5 cm

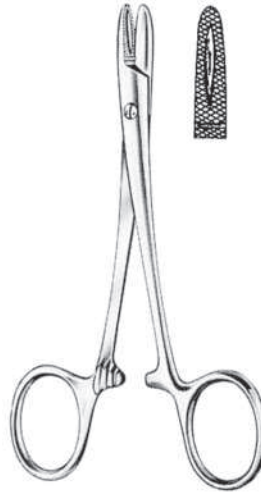

DOYEN
07-070-12
12.5 cm

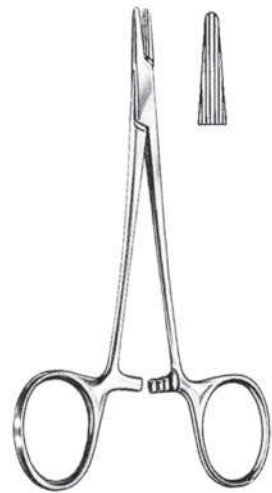

DERF-CONVERSE
07-072-12
12.5 cm



ARRUGA
07-074-16 - 07-075-16
16 cm

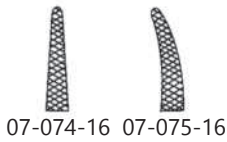

BOYNTON
07-077-12
12 cm

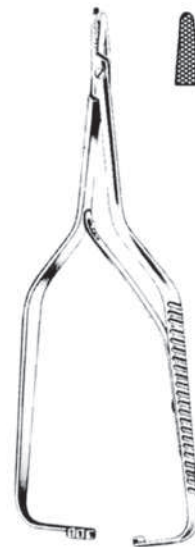

BOYNTON
07-079-12
12 cm

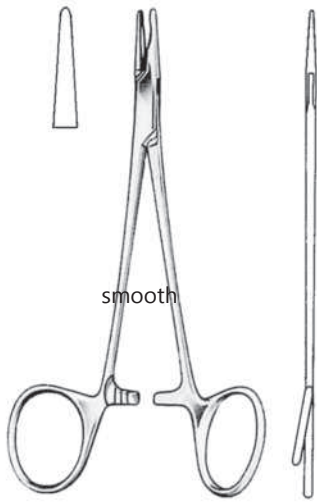

NEIVERT
07-081-13
13 cm

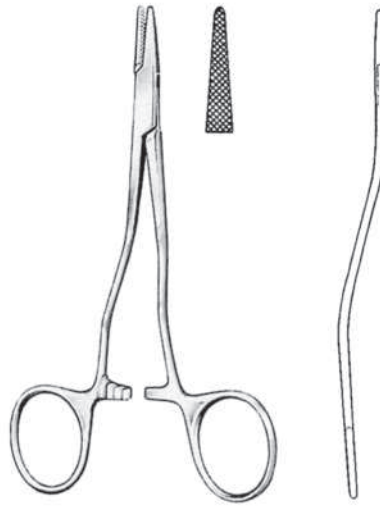

KILNER
07-083-13
13 cm

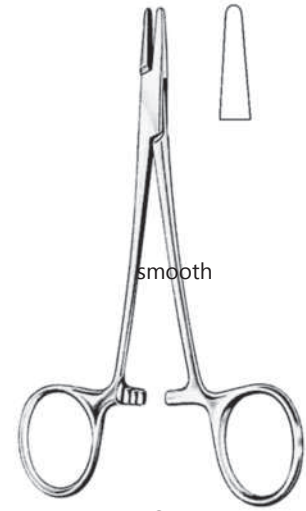

WEBSTER
07-085-13
13 cm

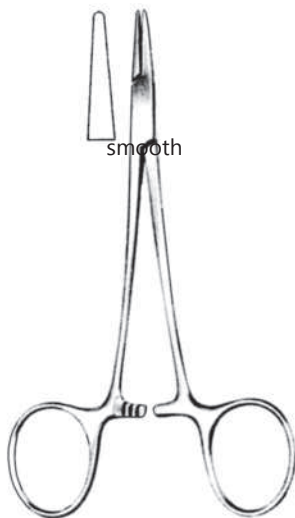

HALSEY
07-087-13
13 cm

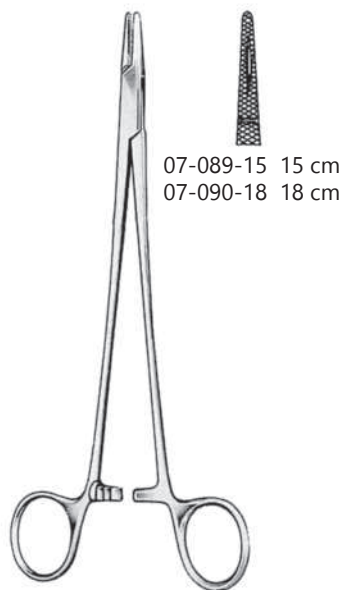

CRILE-WOOD
07-089-15 - 07-090-18

07-089-15 15 cm
07-090-18 18 cm



BABY-CRILE-WOOD
07-092-15
15 cm



BOZEMANN
07-094-20 - 07-096-23



CARROLL
07-098-15
15 cm

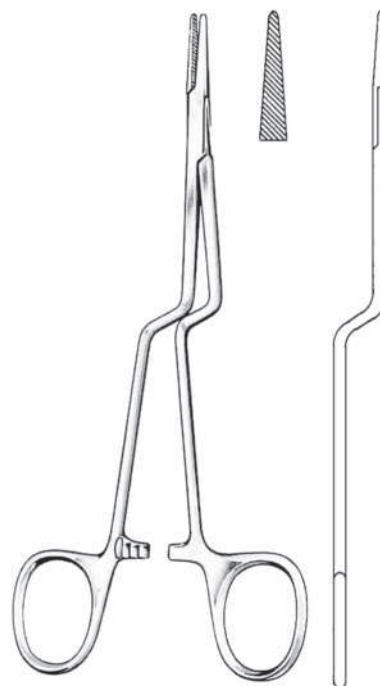

JACOBSON
07-100-18
18 cm



NEW ORLEANS
07-102-18
18 cm

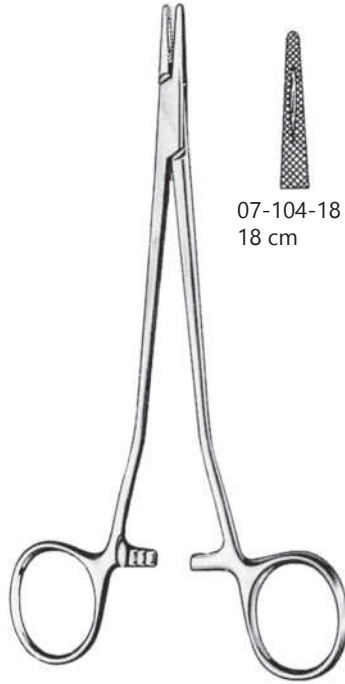

SAROT
07-104-18 - 07-105-26

07-104-18
18 cm

07-105-26
26 cm

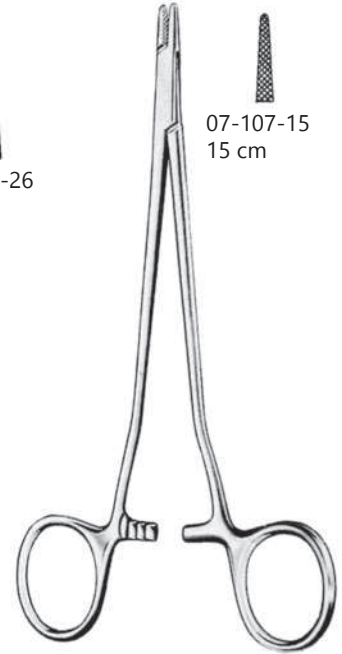

SNNING (Schwed-Model)
07-107-15 - 07-108-17

07-107-15
15 cm

07-108-17
17 cm

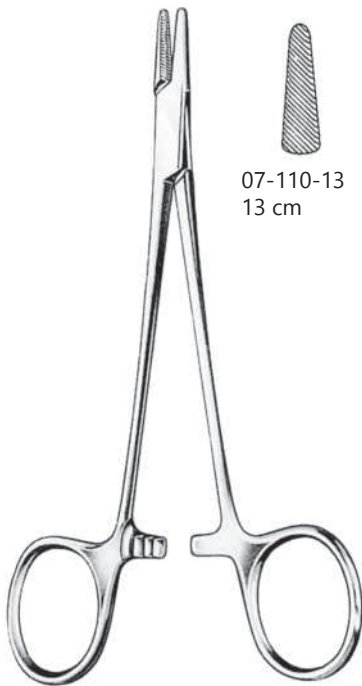

BROWN
07-110-13 - 07-111-18

07-110-13
13 cm

07-111-18
18 cm



M.G.H.
07-113-17
17 cm



ADSON
07-115-18
18 cm

TC GOLD

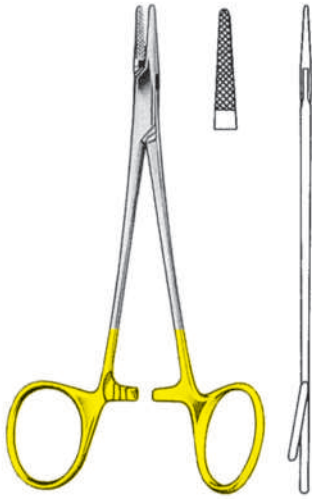

NEIVERT
 07-117-13
 13.5 cm

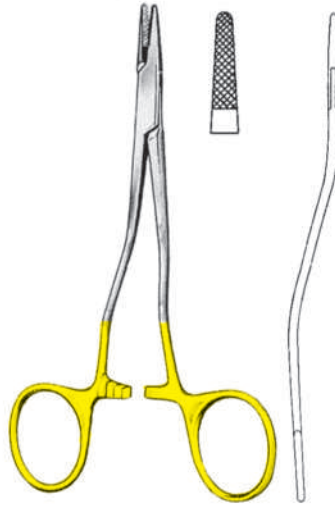

KILNER
 07-119-13
 13.5 cm

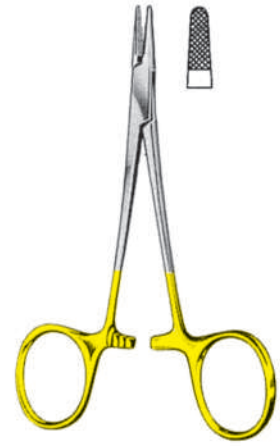

DERF
 07-121-12
 12 cm



HALSEY
 04-123-13 - 07-124-13
 13 cm



WEBSTER
 04-126-13
 13 cm

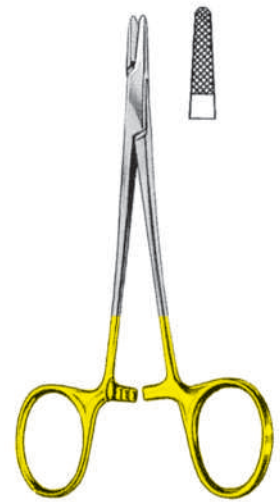

CONVERSE
 04-128-12
 12.5 cm

TC GOLD

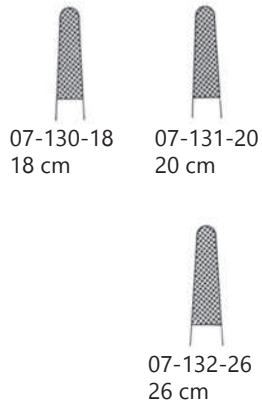
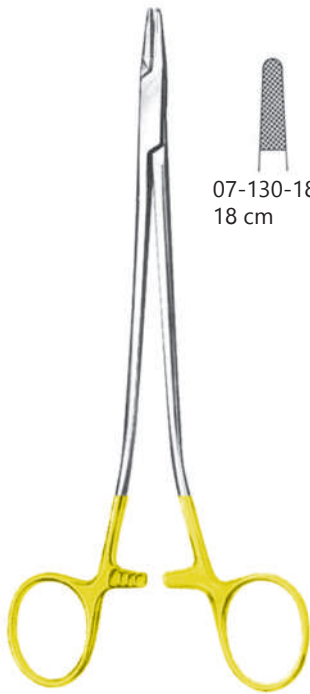

SAROT
 07-130-18 - 07-132-26



METZENBAUM
 07-134-17 - 07-135-19

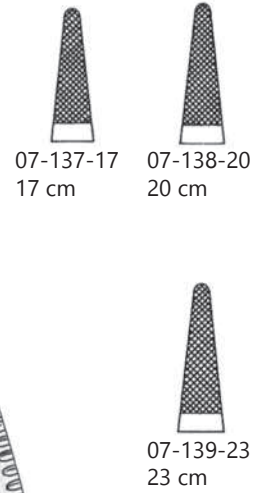

MATHEIU
 07-137-17 - 07-139-23

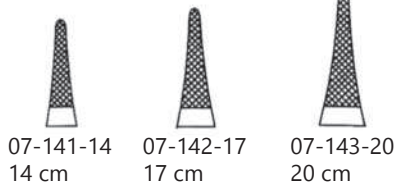

MATHIEU-DELICATE
 07-141-14 - 07-143-20

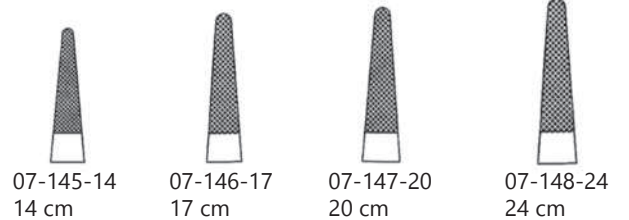

MATHIEU
 07-145-14 - 07-148-24

TC GOLD

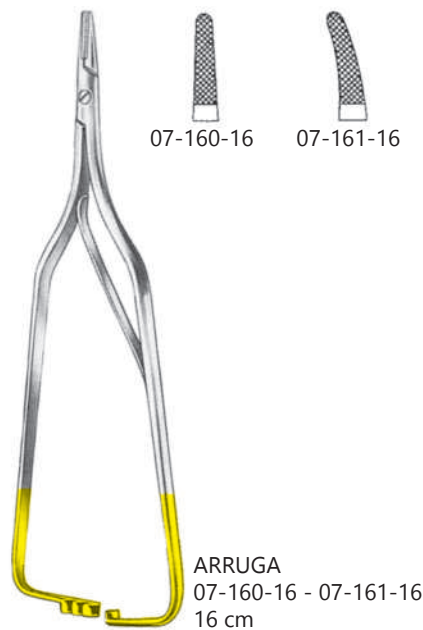
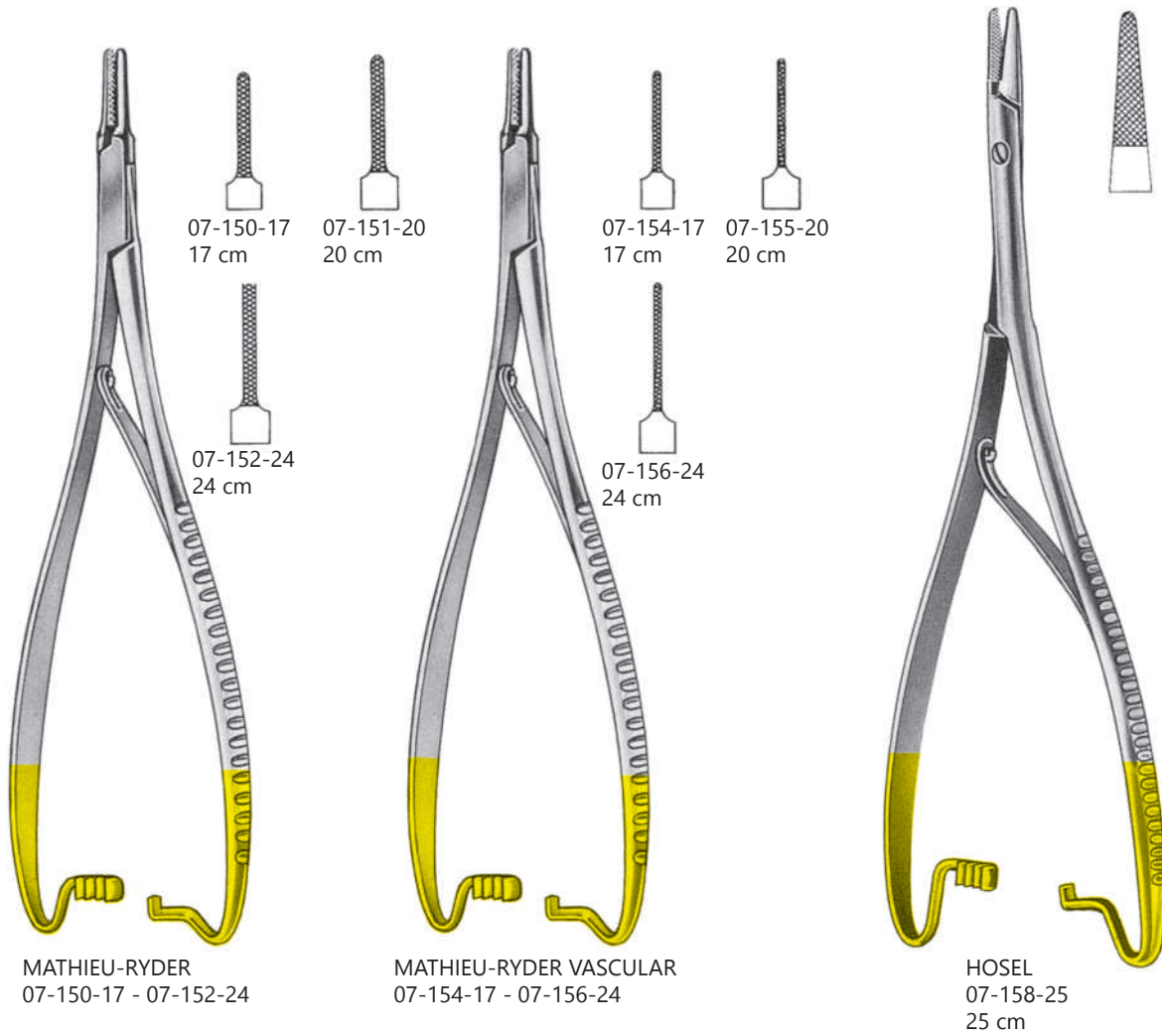

TC GOLD



GILLIES
 07-163-16
 16 cm



WERTHEIM
 07-165-20 - 07-167-30

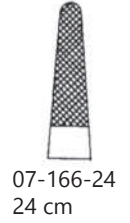







OLSEN-HEGAR
 07-169-14 - 07-171-18





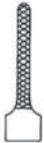



TC GOLD



RYDER VASCULAR
 07-173-13 - 07-184-26

- | | | | | | |
|---|---|---|--|---|---|
|  |  |  |  |  |  |
| 07-173-13
13 cm | 07-174-15
15 cm | 07-175-18
18 cm | 07-176-20
20 cm | 07-177-23
23 cm | 07-178-26
26 cm |

MICRO

- | | | | | | |
|---|---|---|--|---|---|
|  |  |  |  |  |  |
| 07-179-13
13 cm | 07-180-15
15 cm | 07-181-18
18 cm | 07-182-20
20 cm | 07-183-23
23 cm | 07-184-26
26 cm |



delicate model

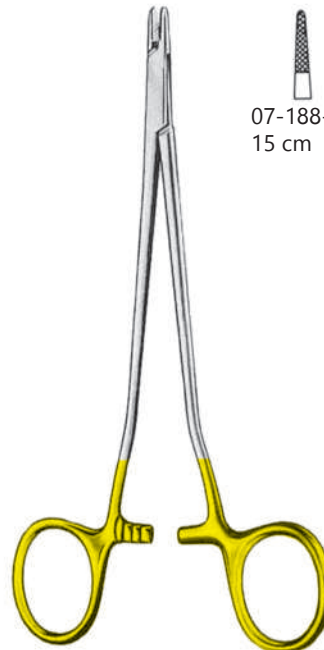

NEW ORLEANS
 07-186-18
 18 cm



SENNING
 07-188-15 - 07-189-17

- | | |
|---|---|
|  |  |
| 07-188-15
15 cm | 07-189-17
17 cm |

TC GOLD

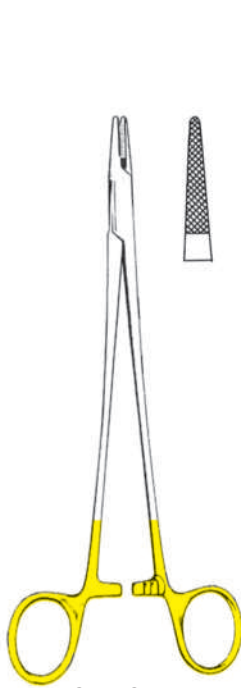

CARROLL
 07-191-15
 15 cm

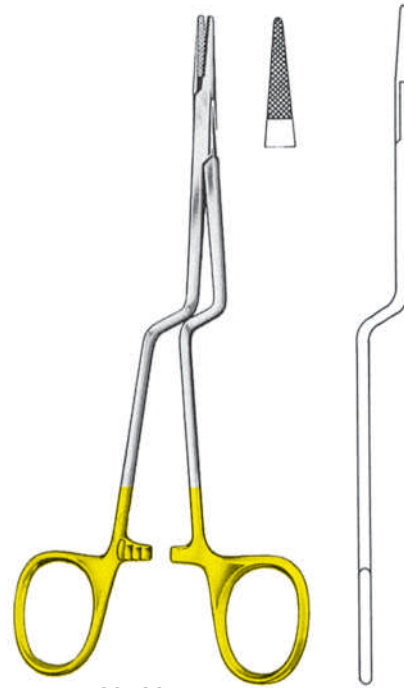

JACOBSON
 07-193-18
 18 cm

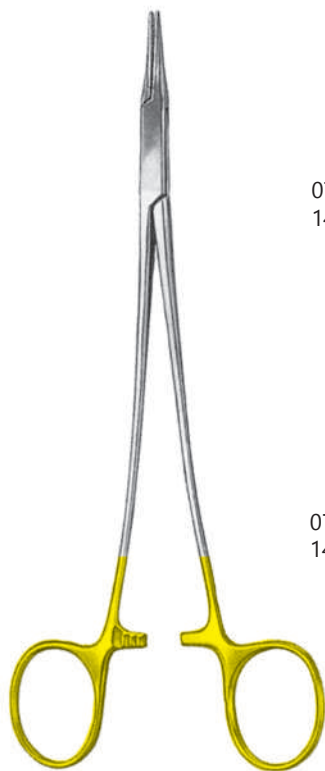

HEGAR VASCULAR
 Microvascular
 07-195-14 - 07-202-23

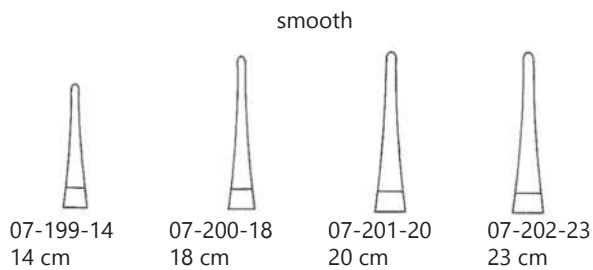
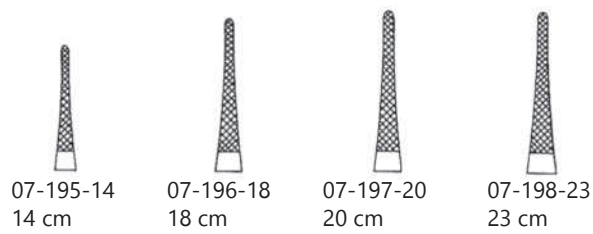

TC GOLD

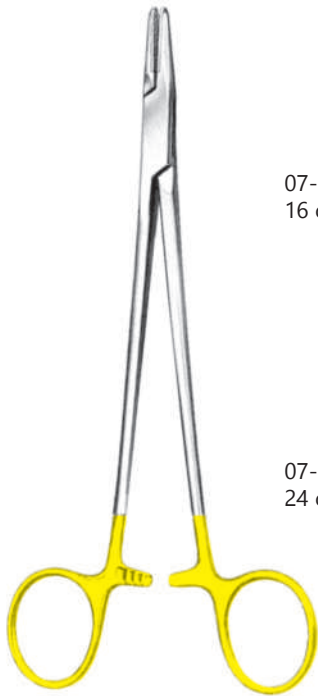

HAYO-HEGAR
 07-204-16 - 07-209-30

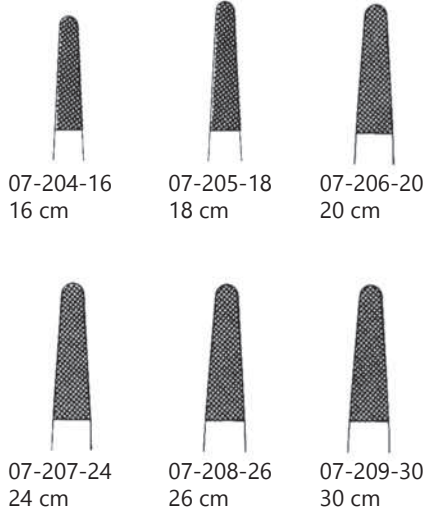

CRILE-WOOD
 07-211-15



DE BAKEY
 07-213-18 - 07-218-37

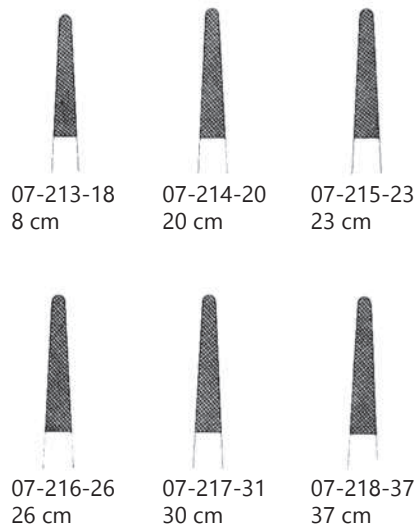

BABY-CRILE-WOOD
 07-220-15



TC GOLD



POTT-SMITH
 07-222-22
 22 cm



KALT
 07-224-13
 13.5 cm



- 07-226-16
16 cm
- 07-227-18
18 cm
- 07-228-20
20 cm
- 07-229-23
23 cm
- 07-230-26
26 cm

DIETRICH
 07-230-26 - 07-230-26

TC GOLD



JACOBSON
 07-232-21 - 07-233-21
 21 cm



CASTROVIEJO
 07-235-14 - 07-236-14
 14 cm



CASTROVIEJO
 07-238-14 - 07-239-14
 14 cm



TOENNIS
 07-241-25
 25 cm



BOYNTON
 07-243-12 - 07-244-12
 12 cm



CASTROVIEJO
 07-246-13
 13 cm

TC GOLD



LICHTENBERG
 07-248-17
 17 cm



ZWEIFEL
 07-250-20 - 07-251-23

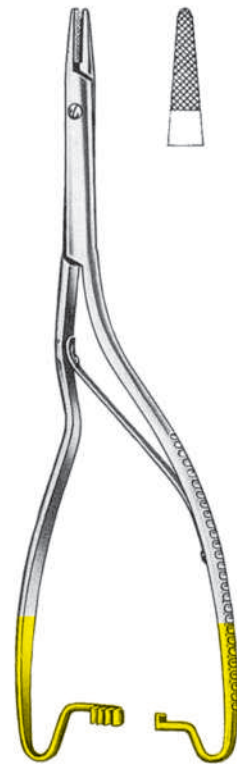
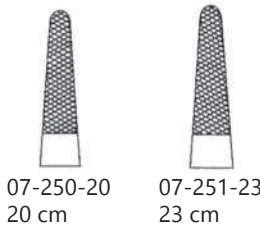

LUETHY-BECK
 07-253-20
 20 cm



EISELSBERG-MATHIEU
 07-255-18
 18.5 cm



LANGENBECK-LEICHT
 07-257-16 - 07-261-25

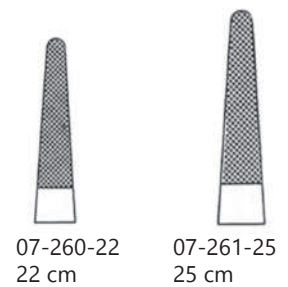
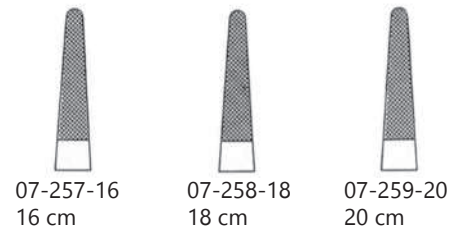

TC GOLD

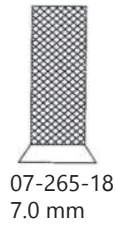
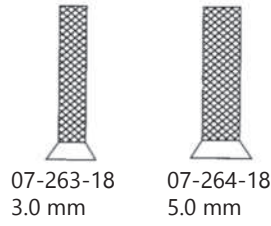

07-263-18 - 07-265-18
 18 cm

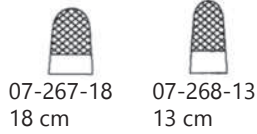

STERNUM
 07-267-18 - 07-268-13

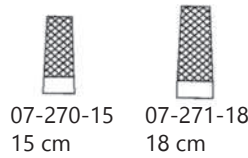

07-270-15 - 07-271-18



07-270-15
 18.5 cm

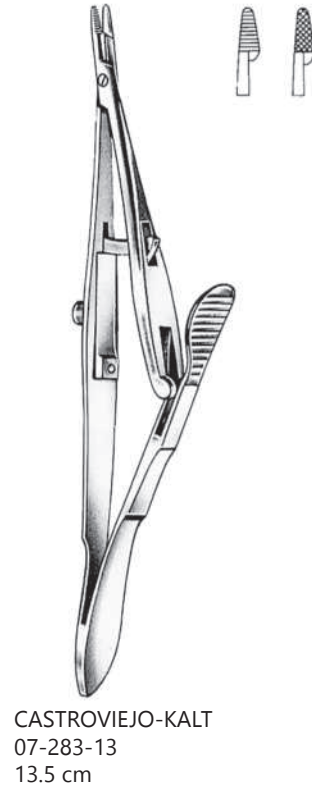
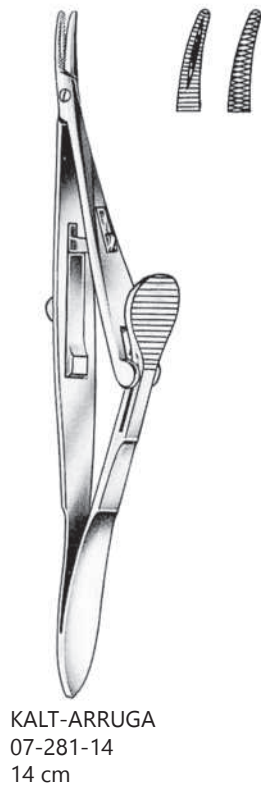

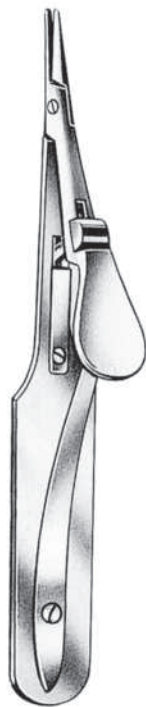

ARRUGA
 07-285-14 - 07-286-14
 14 cm

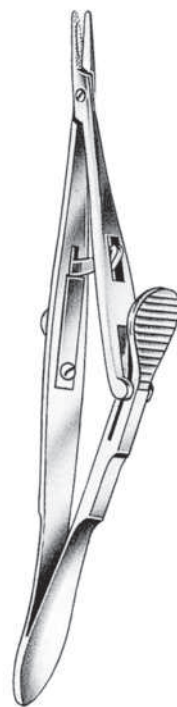

KALT
 07-288-14
 14 cm



07-290-13 13 cm
 07-291-15 15 cm

STEVENS
 07-290-13 - 07-291-15

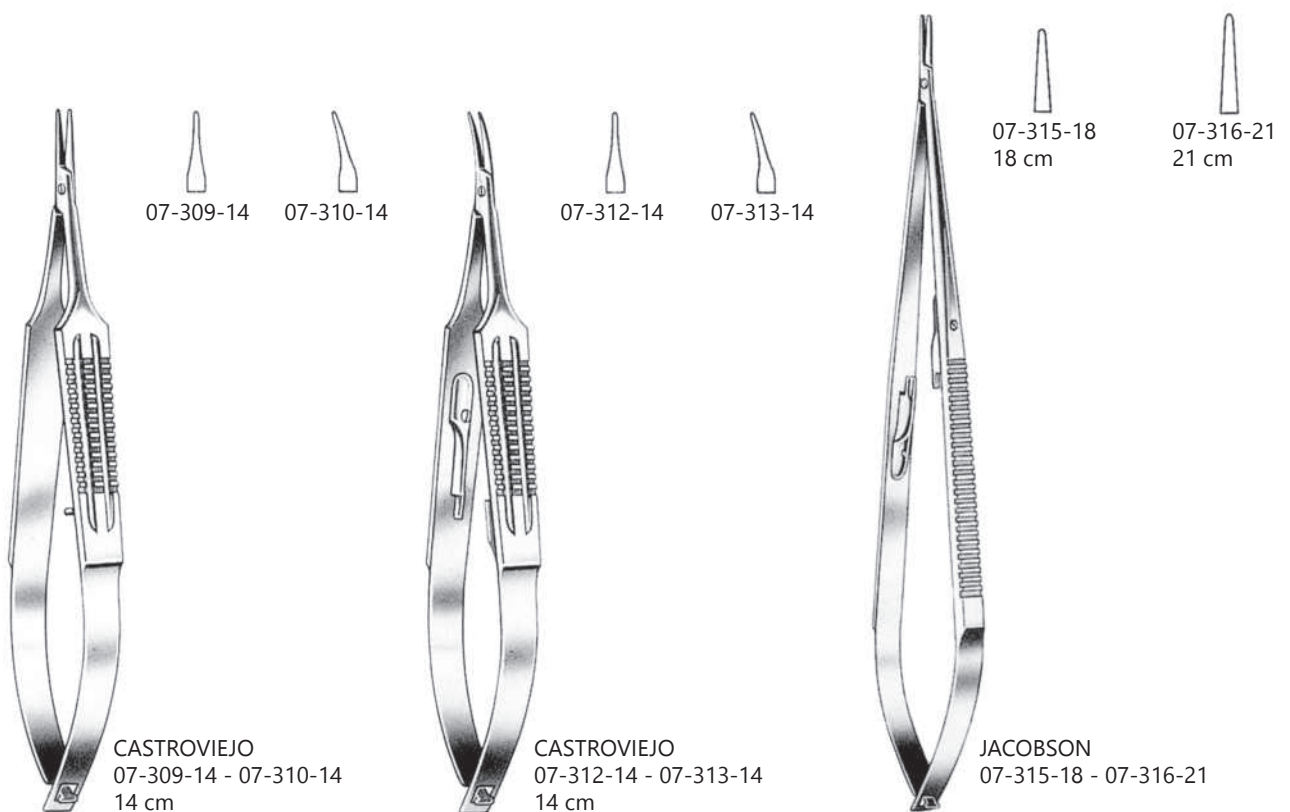
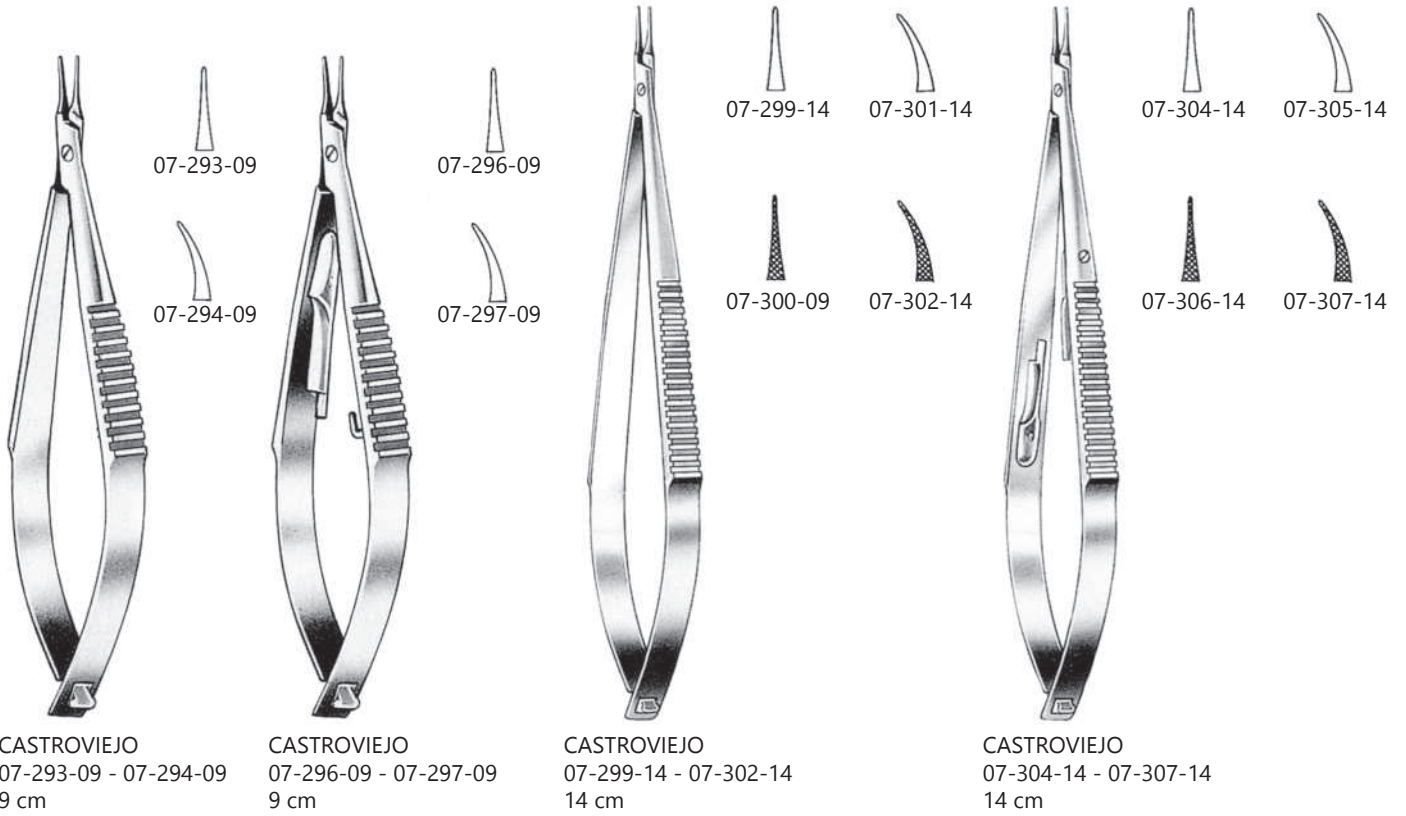



BARRAQUER
 07-318-11
 11 cm



BARRAQUER
 07-320-13
 13 cm



BARRAQUER
 07-322-14
 14 cm



BARRAQUER
 07-324-14
 14 cm

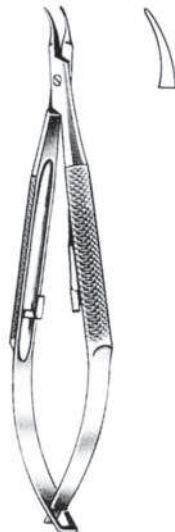

BARRAQUER
 07-326-14
 14 cm



07-328-00
 14 cm



TROUTMAN
 07-330-12
 12 cm

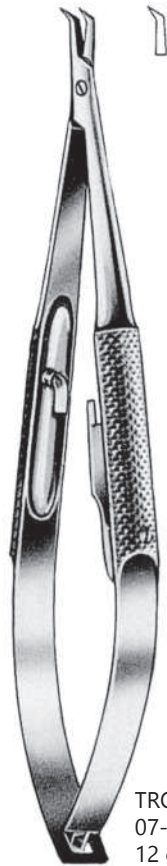

TROUTMAN
 07-332-12
 12 cm

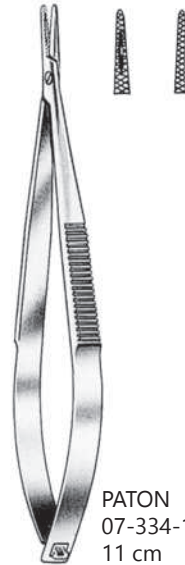

PATON
 07-334-11
 11 cm



PATON
 07-336-11
 11 cm

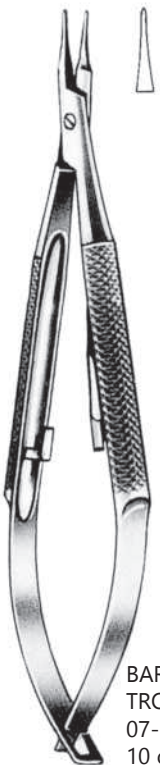

BARRAQUER-
 TROUTMAN
 07-338-10
 10 cm

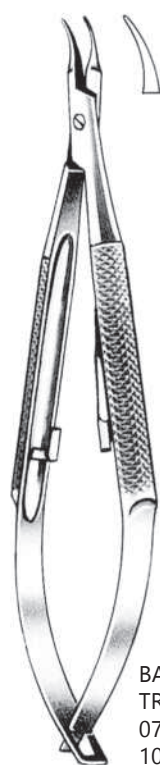

BARRAQUER-
 TROUTMAN
 07-340-10
 10 cm

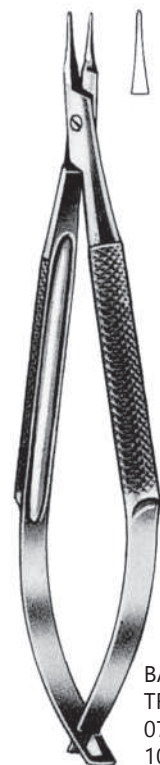

BARRAQUER-
 TROUTMAN
 07-342-10
 10 cm



BARRAQUER-
 TROUTMAN
 07-344-10
 10 cm



07-346-14
 14 cm



07-348-14
 14 cm



REILL
 07-350-15 - 07-351-15
 15 cm



07-350-15



07-351-15



REILL
 07-353-15 - 07-354-15
 15 cm



07-353-15



07-354-15



07-356-18
18 cm



07-358-18
18 cm



07-360-18
18 cm



07-362-18
18 cm

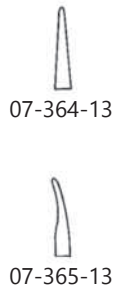
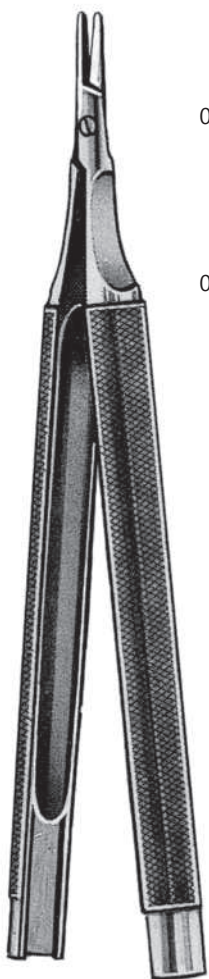

07-364-13

07-365-13

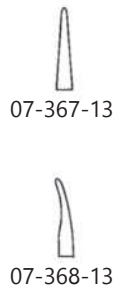
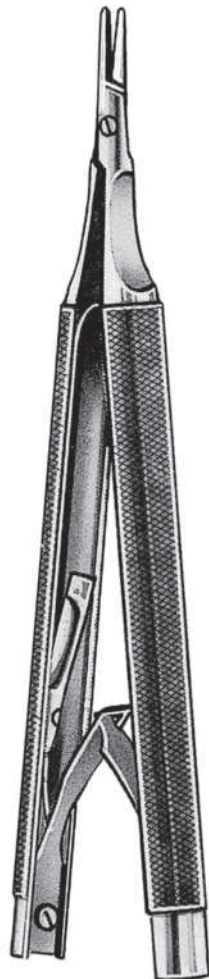

07-367-13

07-368-13

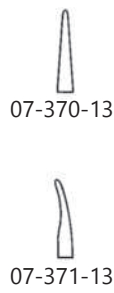
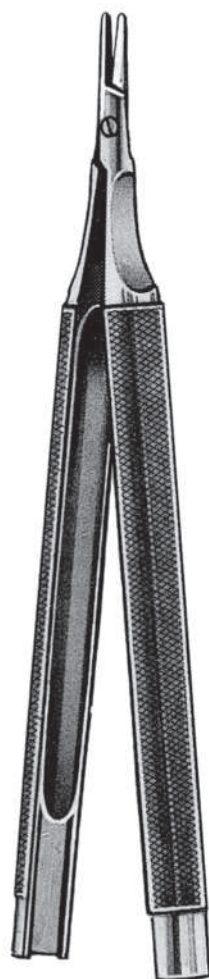

07-370-13

07-371-13

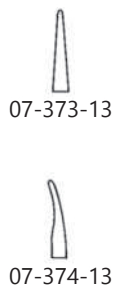
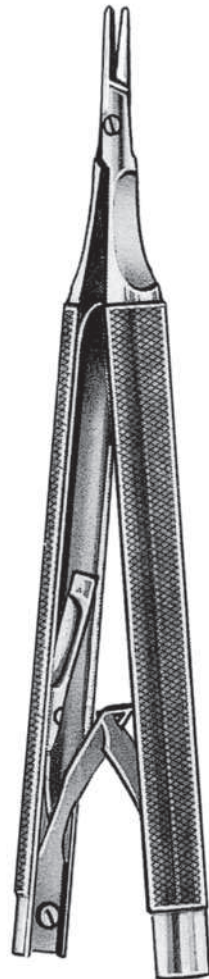

07-373-13

07-374-13

CASTROVIEJO
 07-364-13 - 07-365-13
 13 cm
 handle 8 mm Ø

CASTROVIEJO
 07-367-13 - 07-368-13
 13 cm
 handle 8 mm Ø

CASTROVIEJO
 07-370-13 - 07-371-13
 13 cm
 handle 10 mm Ø

CASTROVIEJO
 07-373-13 - 07-374-13
 13 cm
 handle 10 mm Ø



MICHEL
07-376-12



WACHENFELDT
07-378-12



MICHEL
07-380-12



RICHTER-HEATH
07-382-14
14 cm



DESCHAMPS
07-384-20
20 cm

DESCHAMPS
07-386-20
20 cm



DESCHAMPS
07-387-20
20 cm

DESCHAMPS
07-388-20
20 cm

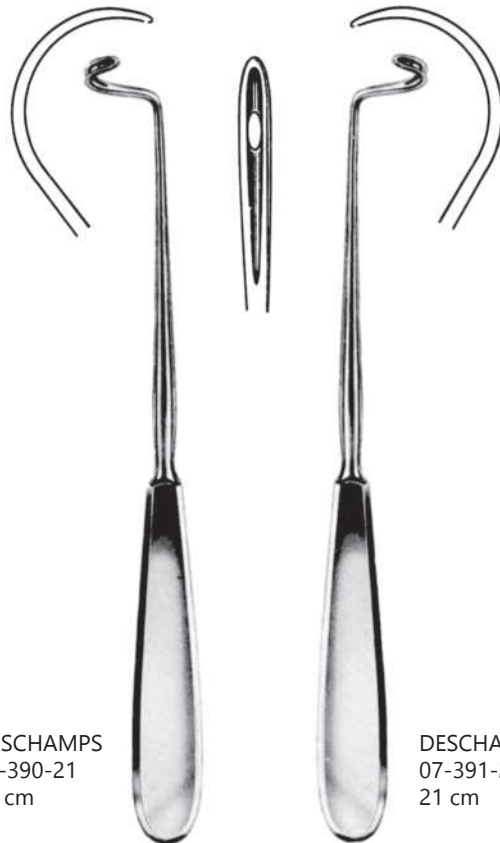

DESCHAMPS
07-390-21
21 cm

DESCHAMPS
07-391-21
21 cm



REVERDIN
 07-393-23
 22.5 cm



REVERDIN
 07-395-19 - 07-402-23



07-395-19 19.5 cm
 07-396-23 23.5 cm



07-397-19 19.5 cm
 07-398-23 23.5 cm



07-399-19 19.5 cm
 07-400-23 23.5 cm



07-401-19 19.5 cm
 07-402-23 23.5 cm



08

Cotton Swab Forceps
Wattestäbchen-Pinzette
Pinzas de algodón

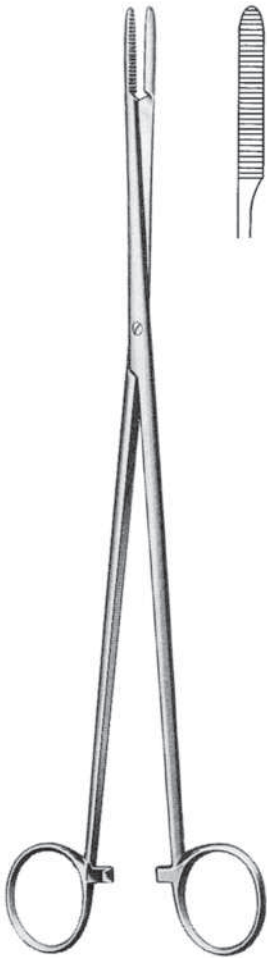

PELKMANN
08-010-25
25 cm

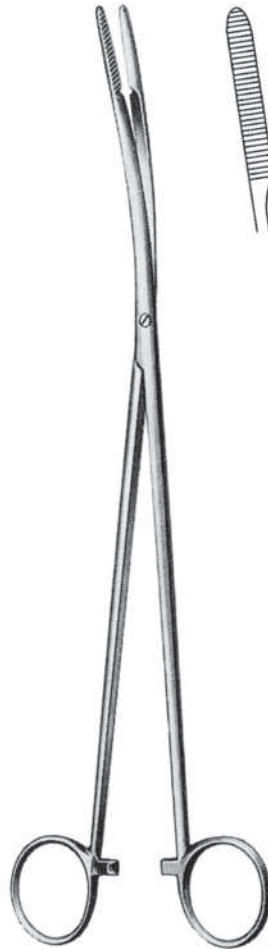

PELKMANN
08-012-25
25 cm

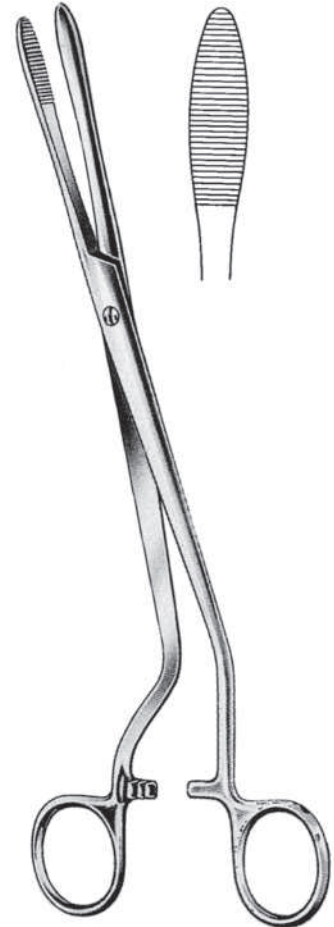

CHERON
08-014-25
25 cm



FLETCHER
08-016-24
24 cm

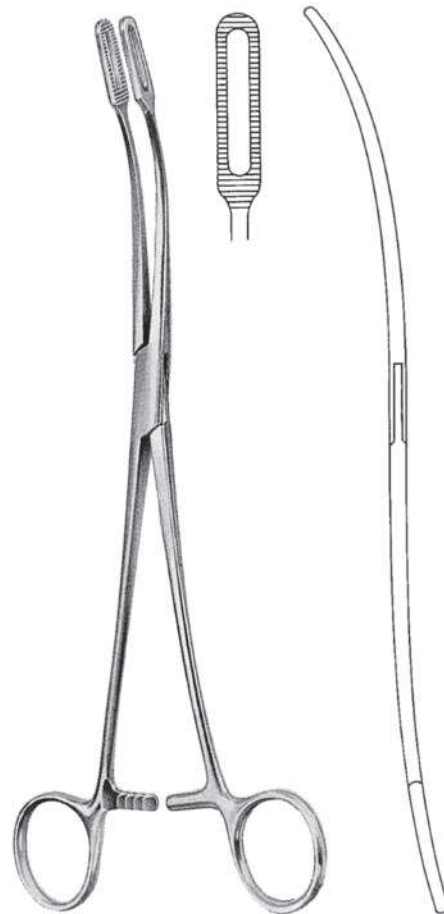

FLETCHER
08-018-24
24 cm



FOERSTER-BALLENGER
 08-020-18 - 08-027-20



08-020-18 18 cm
 08-021-18 20 cm



08-022-18 18 cm
 08-023-18 20 cm



08-024-18 18 cm
 08-025-18 20 cm
 smooth



08-026-18 18 cm
 08-027-18 20 cm
 smooth



FOERSTER-BALLENGER
 08-029-25 - 08-032-25
 25 cm



08-029-25



08-030-25



08-031-25
 smooth



08-032-25
 smooth

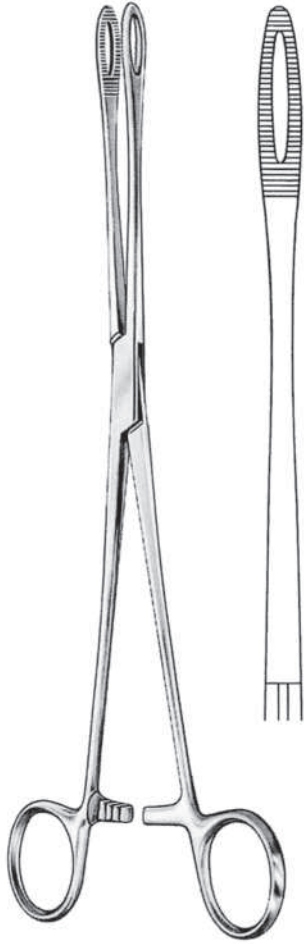

FOERSTER
 08-034-25 - 08-035-25
 25 cm



08-034-25

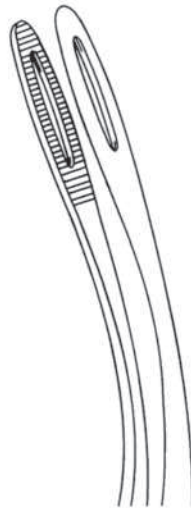

08-035-25



08-037-17 17 cm
 08-038-25 25 cm

WALTON
 08-037-17 17 cm
 08-038-25 25 cm

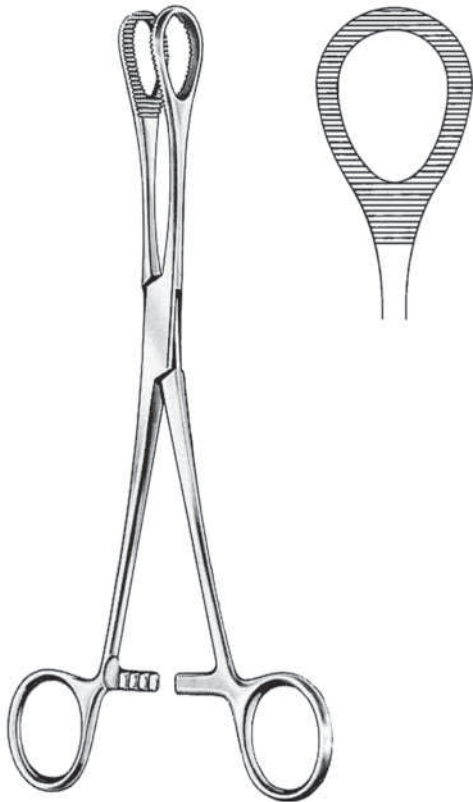

HEYWOOD-SMITH
 08-040-21
 21 cm



DUPLAY
 08-042-20
 20.5 cm

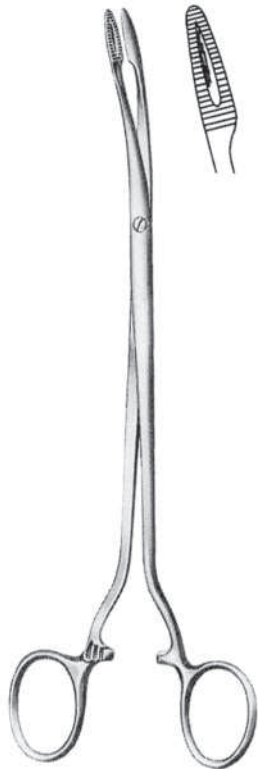

DUPLAY
 08-044-20
 20.5 cm



HEYWOOD-SMITH
 08-046-25
 25 cm



LISTER
08-048-16
16 cm

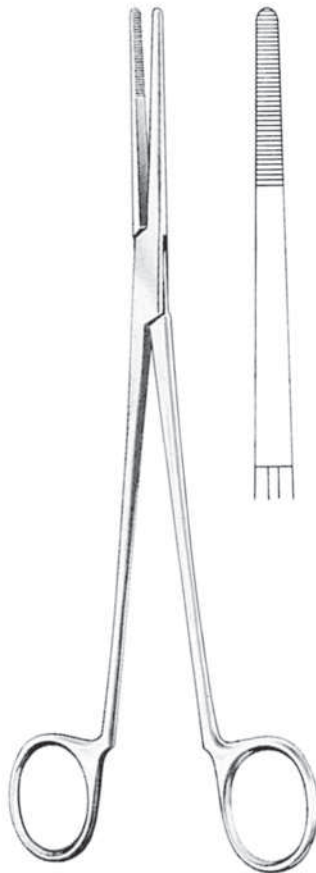

WESTERMARK
08-050-23
23 cm

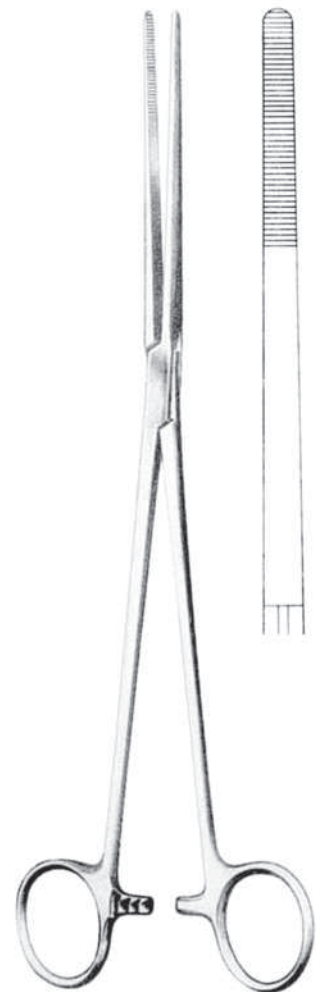

BOZEMANN
08-052-26
26 cm

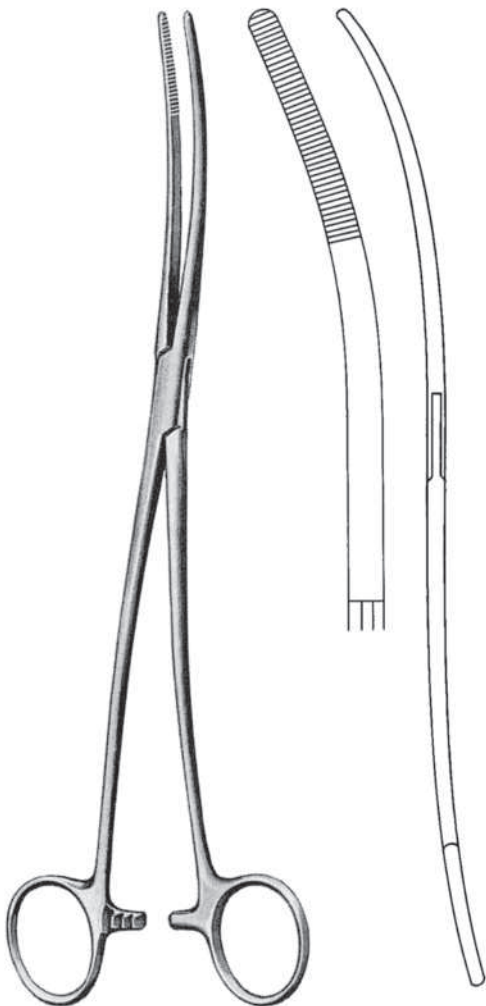

BOZEMANN
08-054-26
26 cm

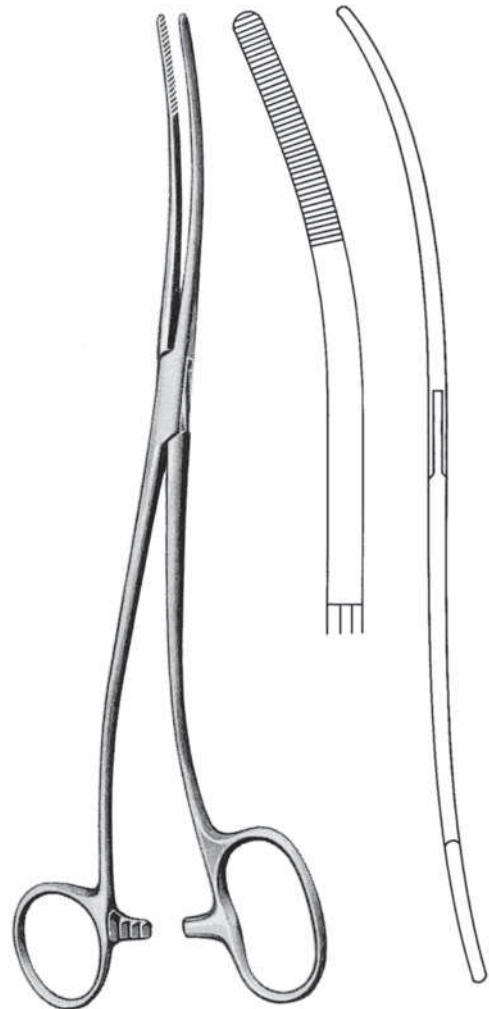

BOZEMANN-DOUGLAS
08-056-26
26 cm

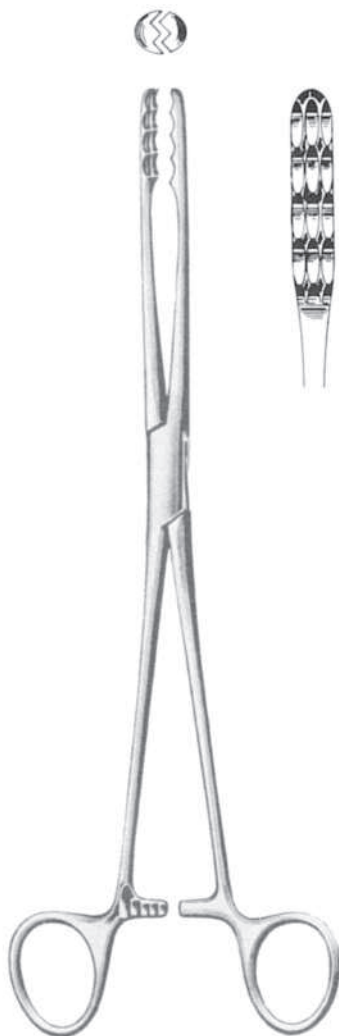

ULRICH
 08-058-22 22 cm
 08-059-25 25 cm



ULRICH
 08-061-22 22 cm
 08-062-25 25 cm

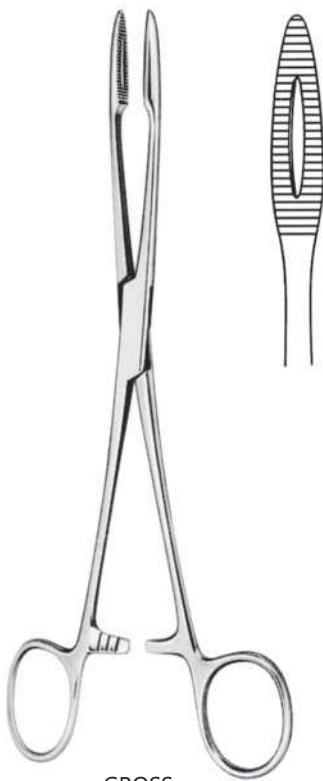

GROSS
08-064-20
20 cm



GROSS
08-066-20
20 cm

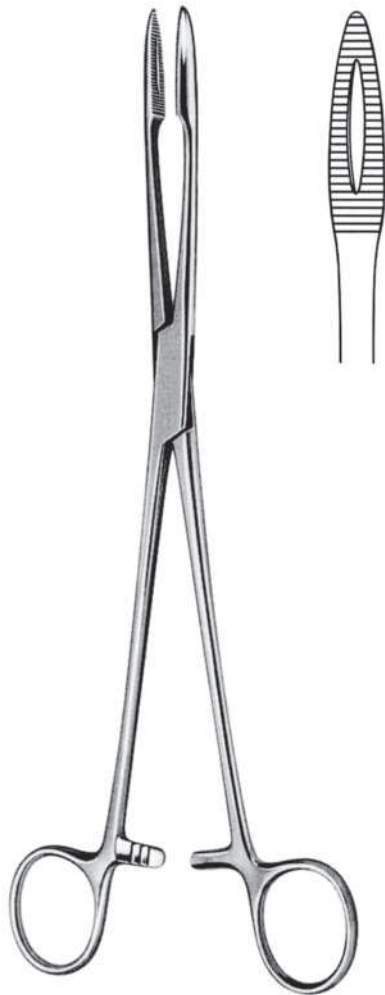

MAIER
08-068-26
26 cm



MAIER
08-070-26
26 cm

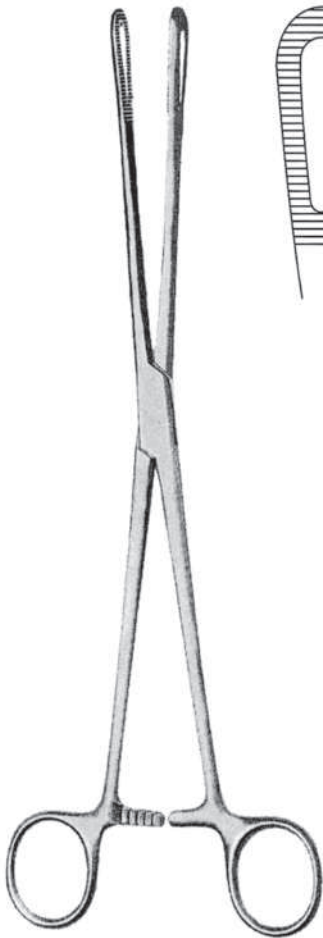

RAMPLEY
08-072-25
26 cm



SIMS-MAIER
08-074-28
28 cm

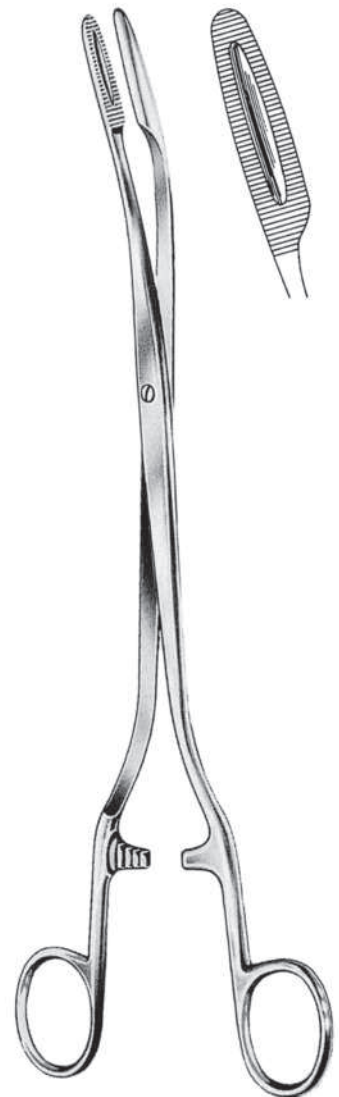

SIMS-MAIER
08-076-28
28 cm



09

Retractors
Wundhaken und - Sperrer
Separadores

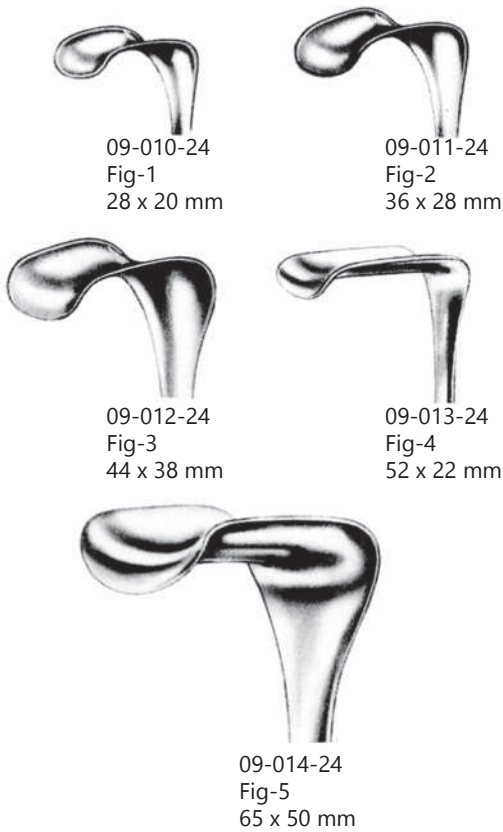

RICHARDSON
(KELLY)
09-010-24 - 09-014-24
24 cm

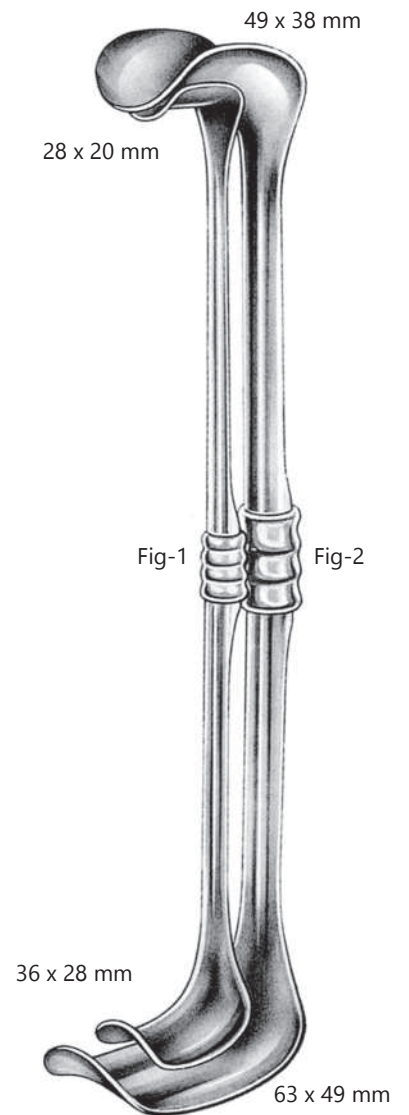

RICHARDSON-EASTMAN
09-016-26 26 cm fig # 1
09-017-28 28 cm fig # 2



MIDDELDORPF
09-019-21 - 09-024-23



09-019-21 21.5 cm
09-020-21 21.5 cm
14 x 17 mm



09-021-22 22 cm
09-022-22 22 cm
20 x 22 mm



09-023-23 23.5 cm
09-024-23 23.5 cm
26 x 30 mm



MIDDELDORPF
09-026-21
09-027-22
09-028-23



LAHEY
09-030-19
19 cm



LITTLE
09-032-20
20 cm

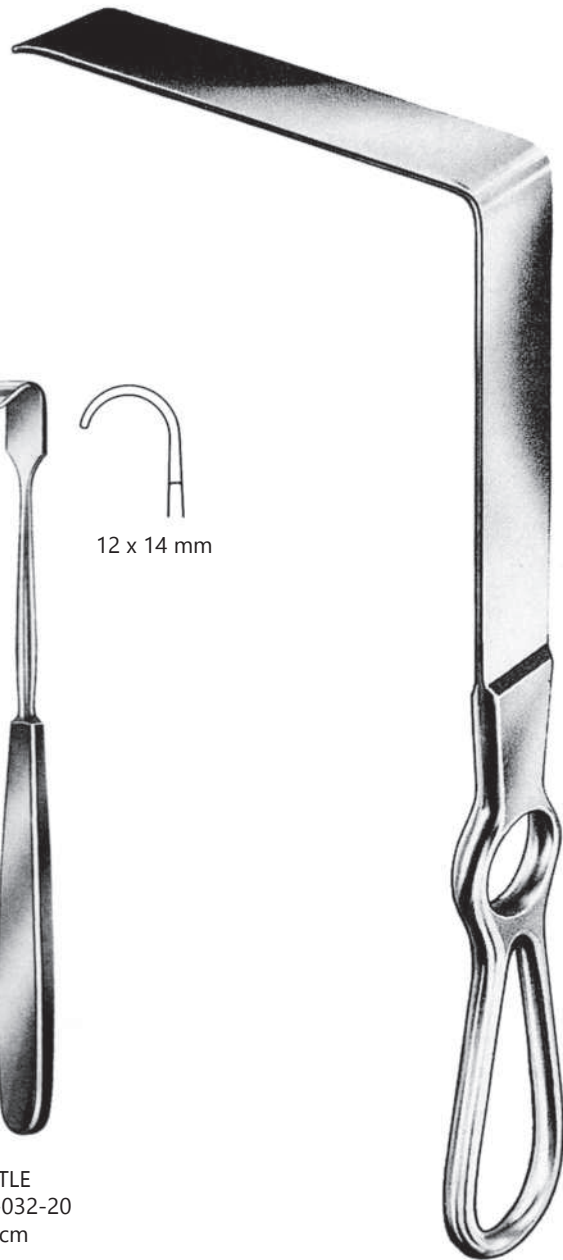

BRUNNER
09-034-25 - 09-039-25
25 cm

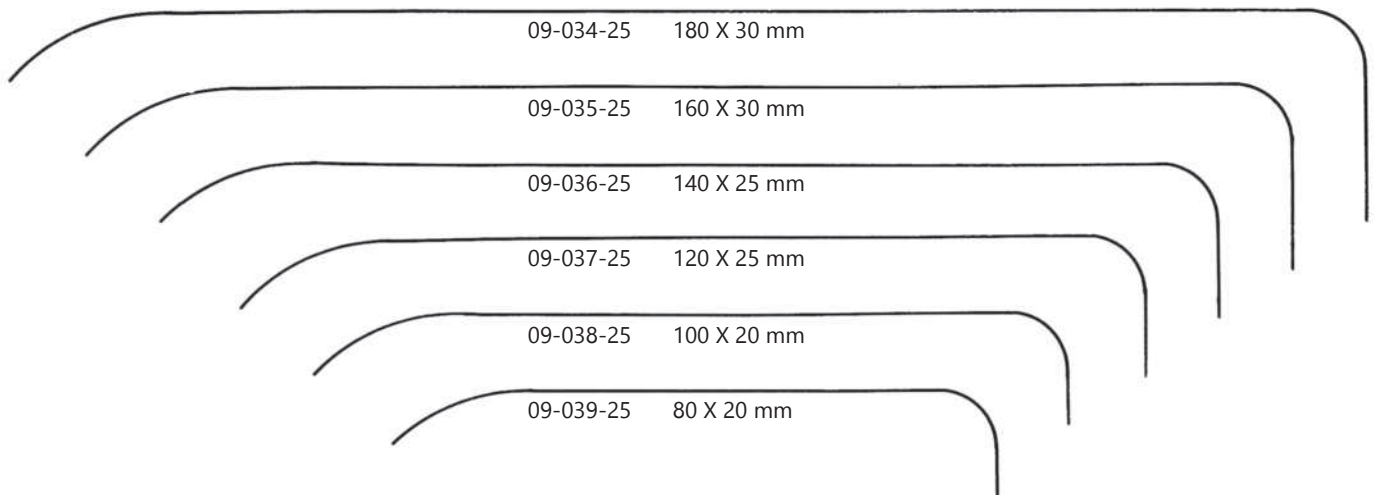

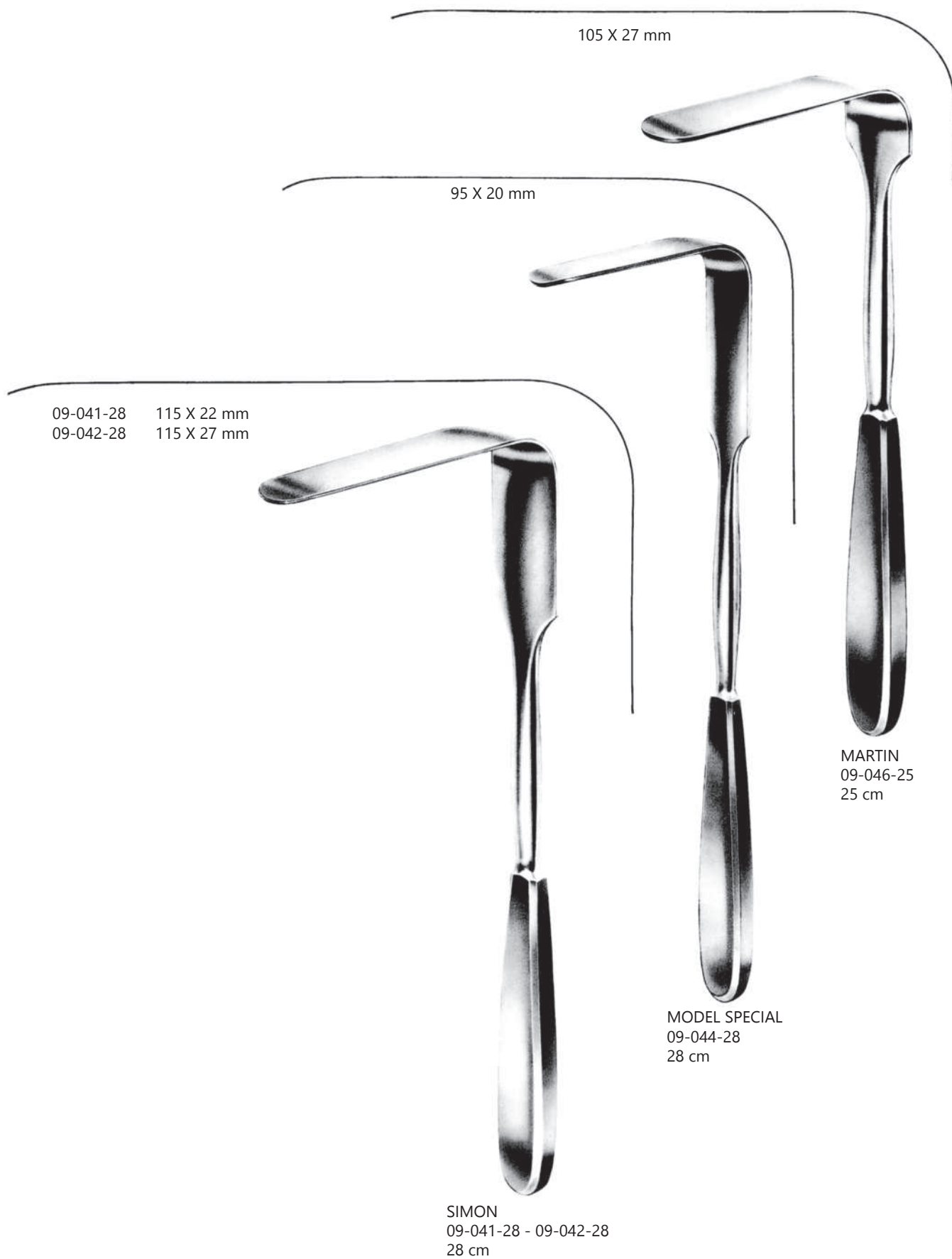



KOCHER
09-048-23 - 09-052-23
23 cm

09-048-23
40 X 18 mm

09-049-23
60 X 20 mm

09-050-23
60 X 25 mm

09-051-23
75 X 30 mm

09-052-23
75 X 40 mm

09-054-22
44 X 16 mm

09-055-22
55 X 22 mm

09-056-22
72 X 19 mm

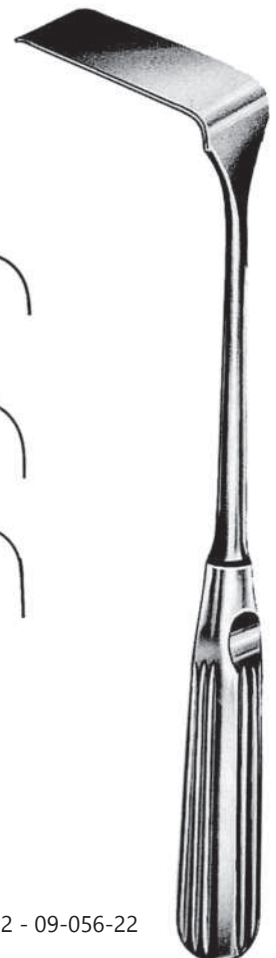

KOCHER
09-054-22 - 09-056-22
22.5 mm



09-058-21
25 X 6.0 mm



09-059-21
35 X 8.0 mm



09-060-21
35 X 11 mm



09-061-21
35 X 15 mm



09-062-21
40 X 11 mm



09-063-21
55 X 11 mm



09-064-21
70 X 14 mm



09-065-21
80 X 12 mm



09-066-21
80 X 16 mm



KOCHER-LANGENBECK
09-058-21 - 09-066-21
21.5 cm



BABY SENN-MILLER
09-068-15 - 09-069-15
15 cm



09-068-15
sharp



09-069-15
blunt



SENN-MILLER
09-071-16 - 09-072-16
16 cm



09-071-15
sharp



09-072-16
blunt



CUSHING
09-074-20
20 cm



RAGNELL-DAVIS
09-076-14
14 cm

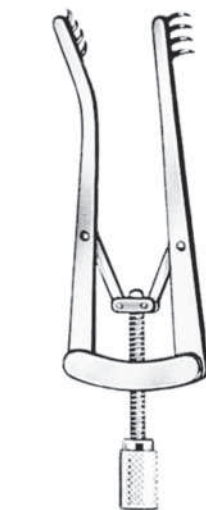
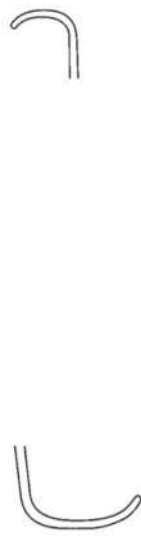

09-078-07 7.0 cm sharp
09-079-07 7.0 cm blunt
09-080-10 10 cm sharp
09-081-10 10 cm blunt



09-083-05 5.0 cm sharp
09-084-05 5.0 cm blunt
09-085-07 7.0 cm sharp
09-086-07 7.0 cm blunt

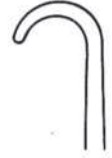

VOLKMANN
09-088-21 - 09-102-21
21 cm



09-104-21
sharp

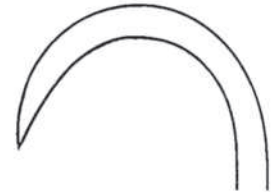

09-107-20
sharp



09-105-21
blunt

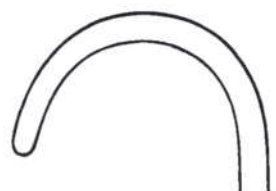

09-108-20
sharp

VOLKMANN
09-104-21 - 09-105-21
21.5 cm

VOLKMANN
09-107-21 - 09-108-21
20 cm

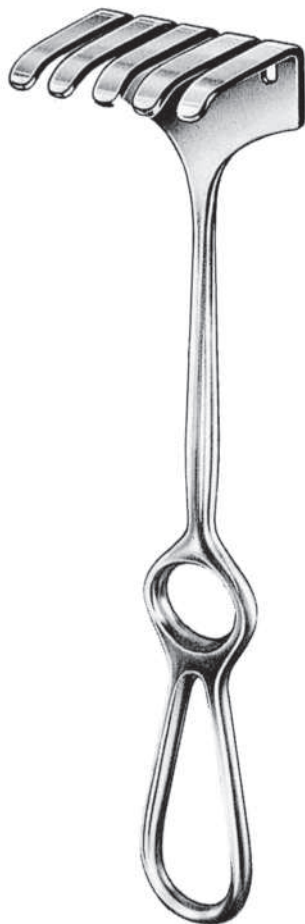

ISRAEL
09-110-25 - 09-113-25
25 cm

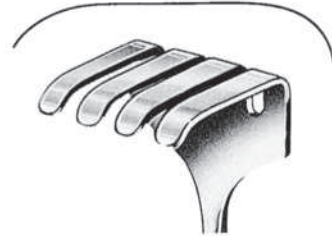

09-110-25
40 x 40 mm

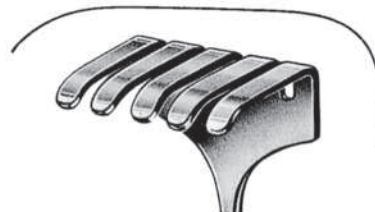

09-111-25
45 x 50 mm

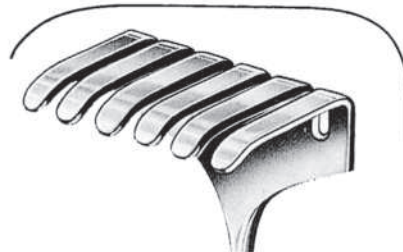

09-112-25
50 x 60 mm

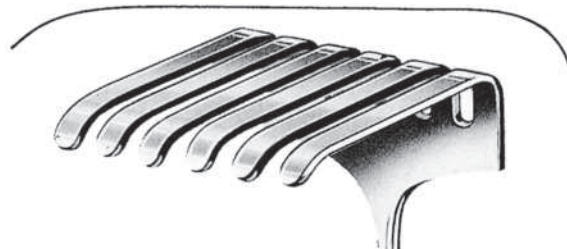

09-113-25
70 x 70 mm



KOERTE
09-115-24 - 09-116-24
24 cm



09-115-24
26 x 40 mm
sharp



09-116-24
26 x 40 mm
blunt

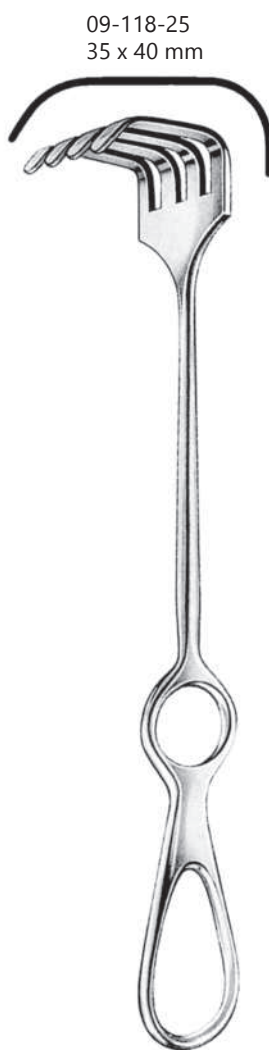

09-118-25
35 x 40 mm

BILLROTH
09-118-25 - 09-120-25
25 cm



09-119-25
43 x 35 mm



09-116-24
45 x 50 mm



09-122-22
36 x 60 mm

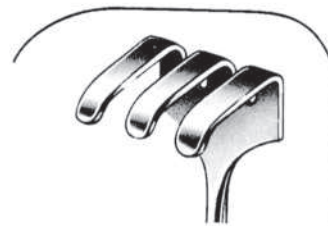

09-123-22
36 x 30 mm

OLLIER
09-122-22 - 09-23-22
22.5 cm



09-125-22

09-131-22

09-137-22



09-126-22



09-132-22



09-138-22



09-127-22



09-133-22



09-139-22



09-128-22



09-134-22



09-140-22



09-129-22



09-135-22



09-141-22



09-130-22



09-136-22



09-142-22



KOCHER
09-125-22 - 09-142-22
22 cm



09-144-16 - 09-155-16
16 cm



09-157-16 - 09-164-16
16 cm



09-157-16



09-161-16



09-158-16



09-162-16



09-159-16



09-163-16



09-160-16
sharp



09-164-16
blunt



LANGENBECK
09-166-21 - 09-174-21
21 cm

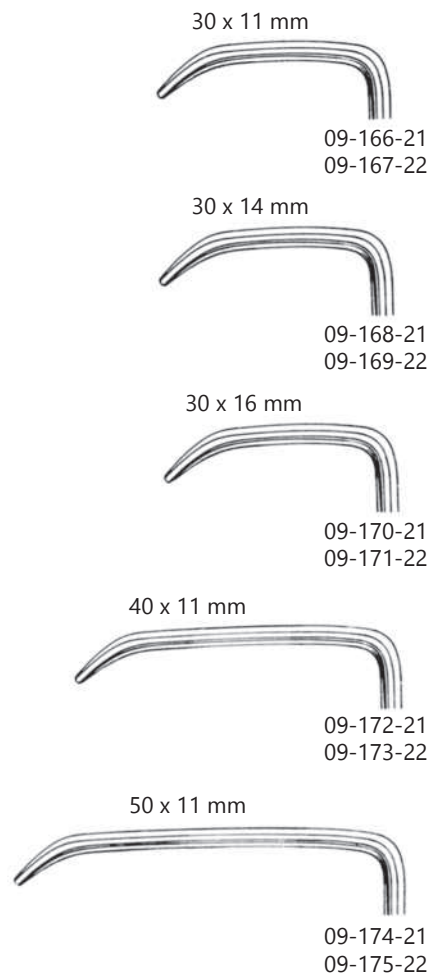

LANGENBECK
09-167-22 - 09-175-22
22 cm



LANGENBECK
09-177-21 - 09-179-20
21 cm

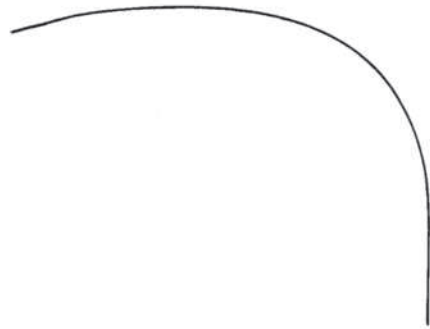

09-177-21
55 x 20 mm

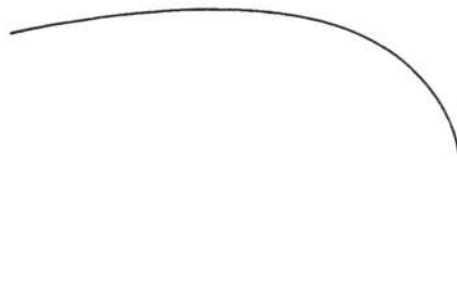

09-178-21
60 x 20 mm

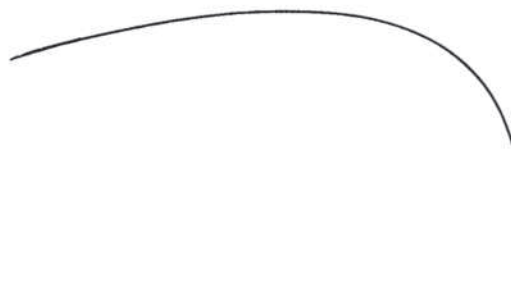

09-179-21
63 x 20 mm



O'CONNOR
09-181-16
16 cm



GRAEFE
09-183-16 - 09-184-16
16 cm



09-183-16
sharp



09-184-16
blunt



09-186-16 - 09-189-16
16 cm



09-186-01
Fig-1



09-187-02
Fig-2



09-188-03
Fig-3



09-189-04
Fig-4



MOLDESTAD
09-191-13
13 cm



CUSHING
09-193-01 - 09-194-02
19 cm



09-193-01
Fig-1



09-194-02
Fig-2



CUSHING
09-196-01 - 09-197-02
28 cm



09-196-01
Fig-1



09-197-02
Fig-2



09-199-01
Fig-1



09-200-02
Fig-2



GILLIES
09-199-01 - 09-200-02
18 cm



KILNER
09-202-15
15 cm



FRAZIER
09-204-13
13 cm



09-206-01
Fig-1



09-207-02
Fig-2



09-208-03
Fig-3

KLEINERT-KUTZ
09-206-01 - 09-208-03
16 cm



09-210-17 - 09-211-17
17 cm



09-210-17
5 mm



09-211-17
7 mm



09-213-18 - 09-214-18
18.5 cm



09-213-19
Ø1.0 mm



09-214-19
Ø1.2 mm



09-216-11
11 cm



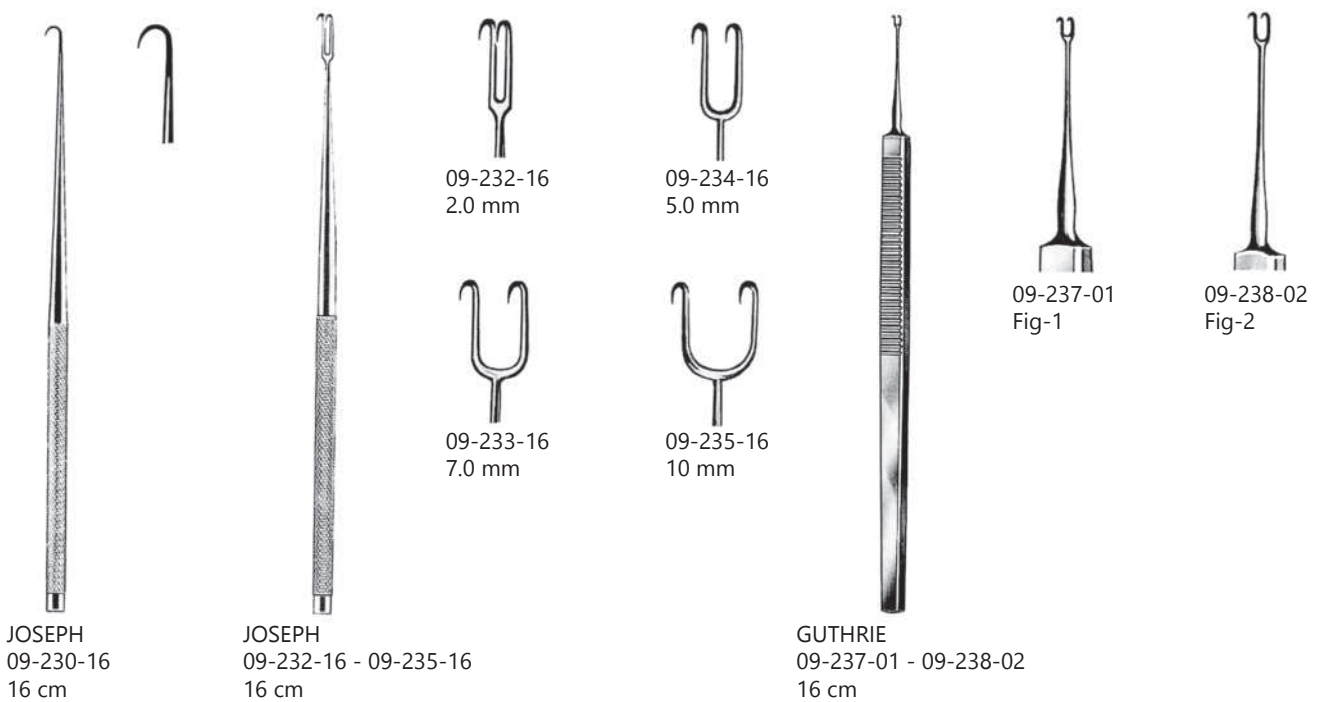
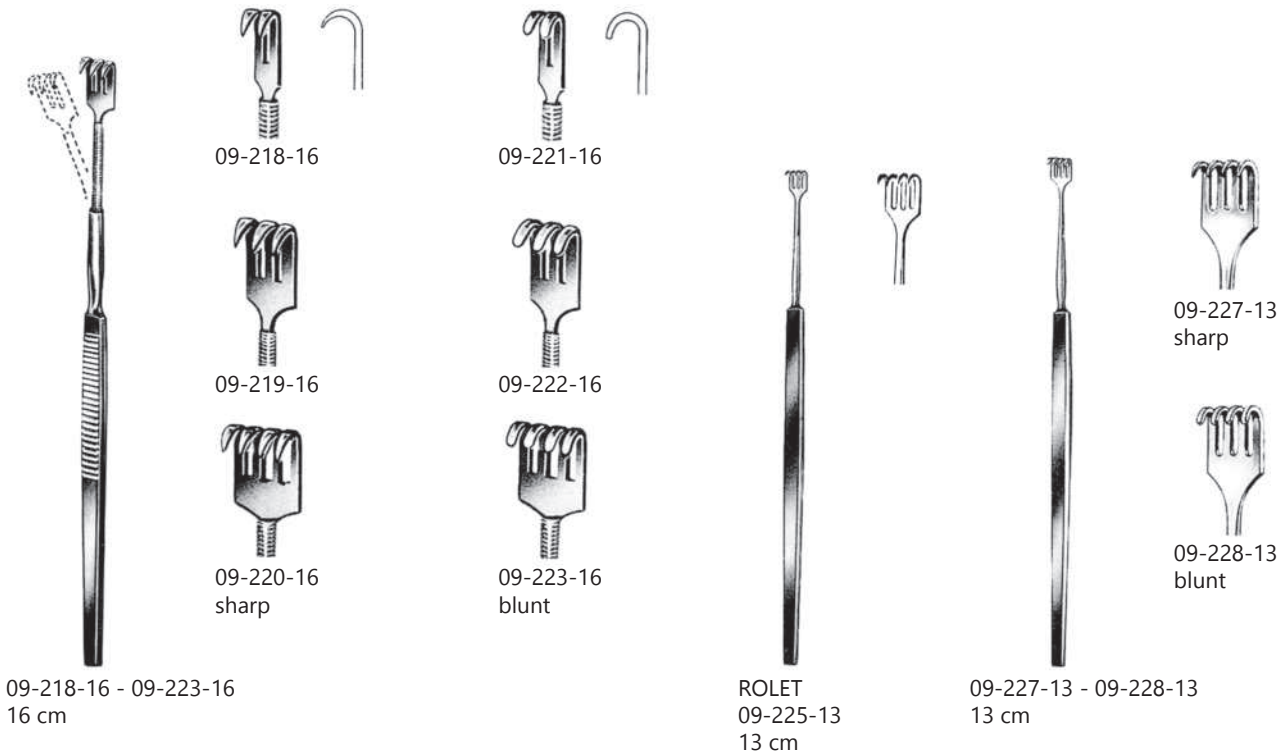



09-240-15
10 X 6 mm



09-241-15
20 X 6 mm

SENN-GREEN
09-240-15 - 09-241-15
15 cm



09-243-16
10 X 6 mm



09-244-16
17 X 5 mm



09-245-16
20 X 6 mm



09-246-16
21 X 8 mm

MINI-LANGENBECK
09-243-16 - 09-246-16
16 cm



09-248-25
25 X 7 mm



09-249-25
25 X 7 mm

09-248-25 - 09-249-25
25 cm



DESMARRES
09-251-01 - 09-255-05
13 mm



09-251-01
10 mm
Fig-1



09-252-02
12 mm
Fig-2



09-253-03
14 mm
Fig-3



09-254-04
16 mm
Fig-4



09-255-05
18 mm
Fig-5



DESMARRES
09-257-16 - 09-262-16
16 mm



09-257-16
8.0 mm



09-258-16
10 mm



09-259-16
12 mm



09-260-16
14 mm



09-261-16
16 mm



09-262-16
18 mm



CUSHING
09-264-20 - 09-269-20
20 mm



09-264-20
8.0 mm



09-265-20
10 mm



09-266-20
12 mm



09-267-20
14 mm



09-268-20
16 mm



09-269-20
18 mm



CUSHING
09-271-24 - 09-276-24
24 mm



09-271-24
8.0 mm



09-272-24
10 mm



09-273-24
12 mm



09-274-24
14 mm



09-275-24
16 mm



09-276-24
18 mm

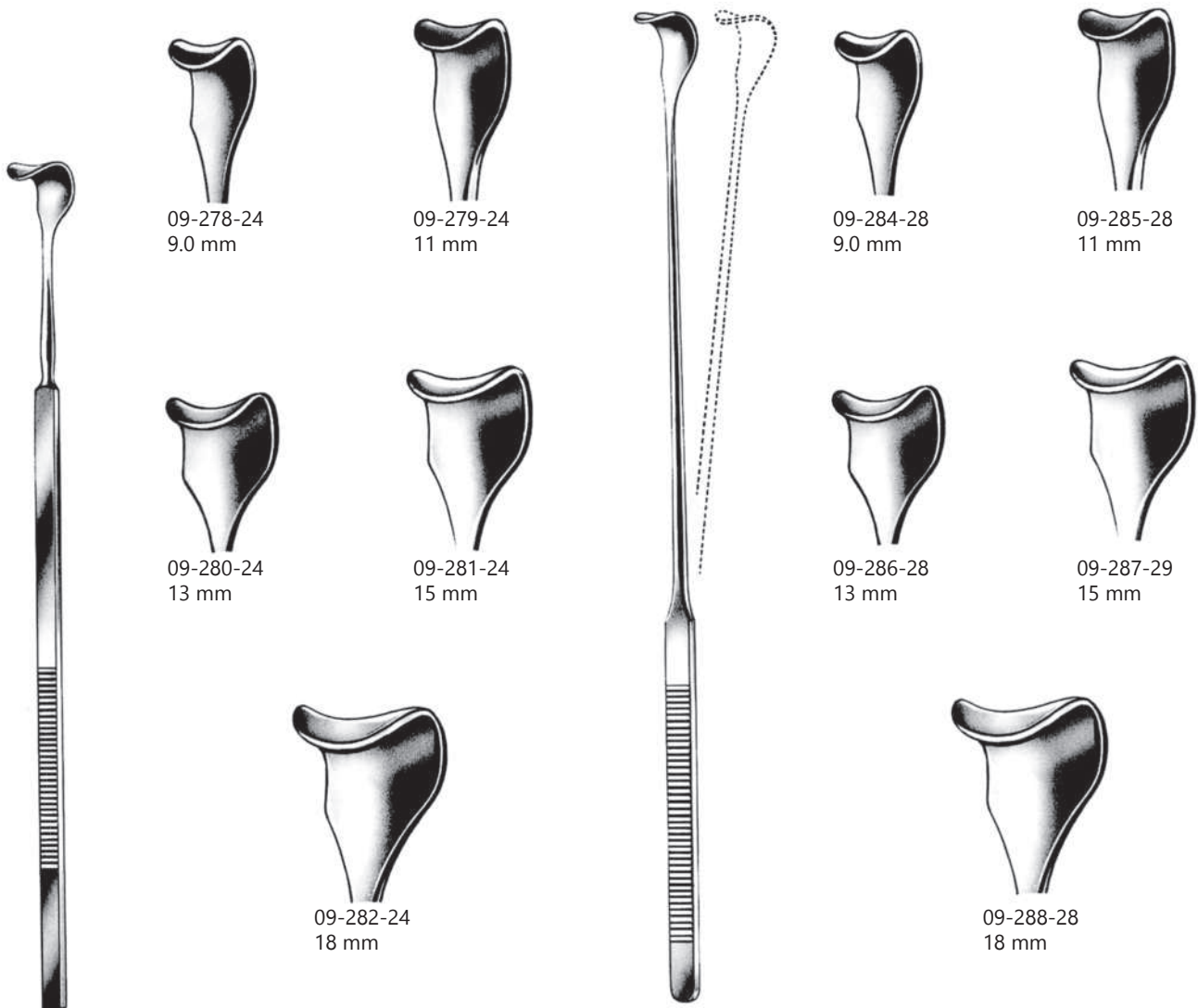

GILL-VERNET
09-278-24 - 09-082-24
24.5 cm

GILL-VERNET
09-284-28 - 09-088-28
28 cm



HOESEL
09-290-25 - 09-295-25
25 cm



09-290-25
80 x 20 mm

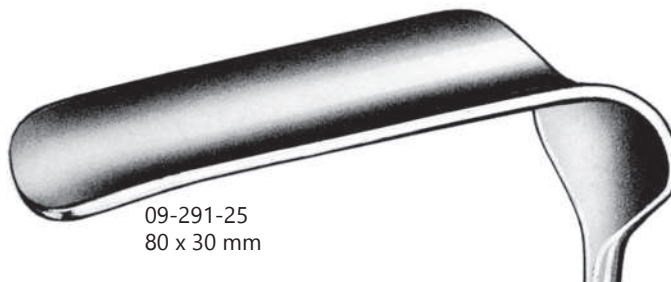

09-291-25
80 x 30 mm

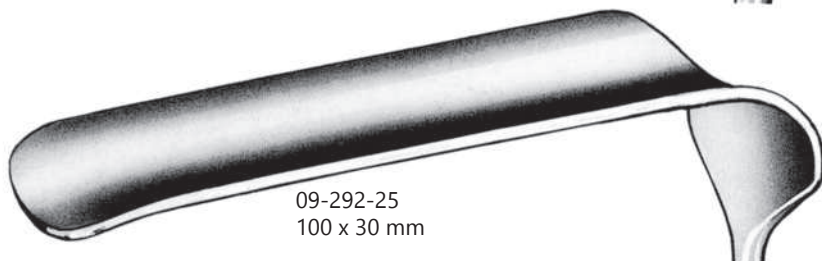

09-292-25
100 x 30 mm

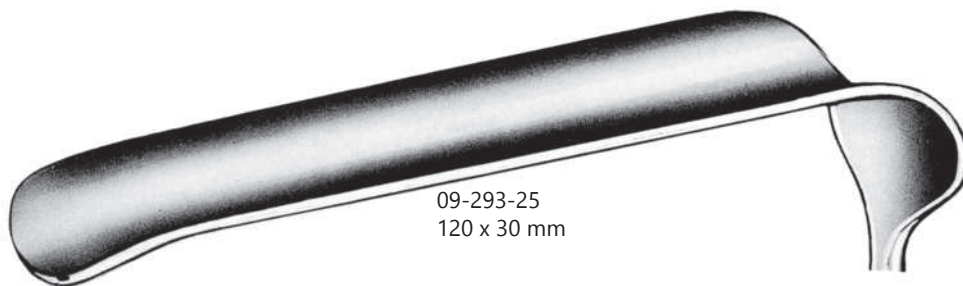

09-293-25
120 x 30 mm

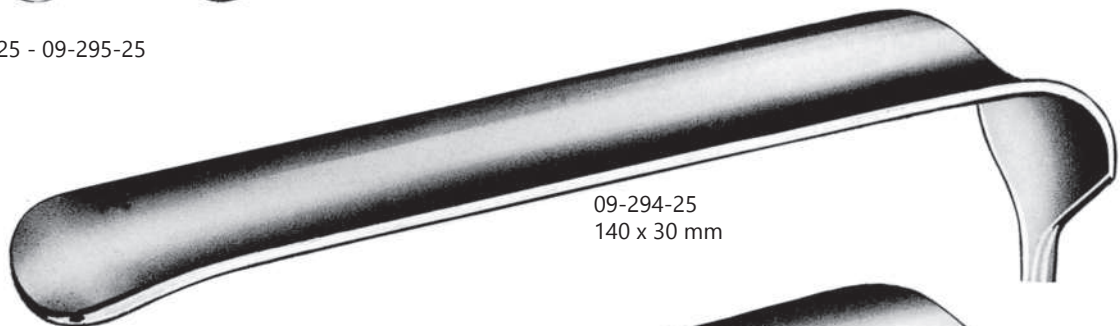

09-294-25
140 x 30 mm

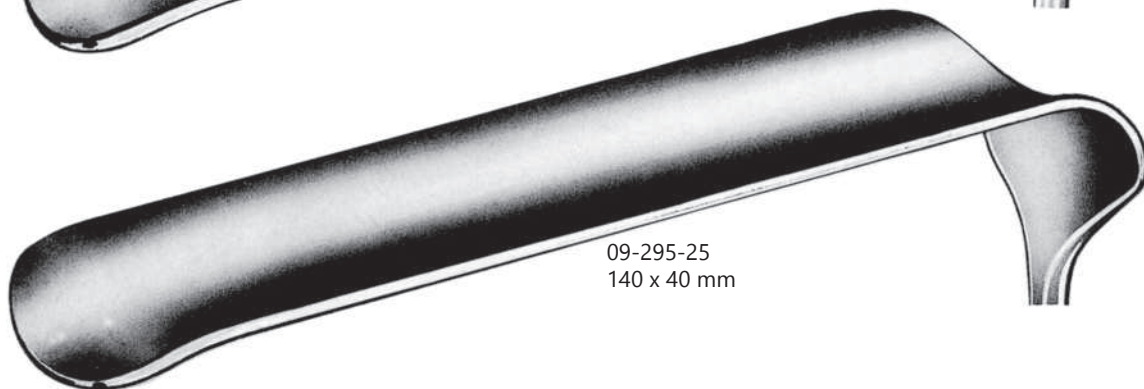

09-295-25
140 x 40 mm



FRITSCH

09-294-24 24 cm 45 x 40 mm
09-298-24 24 cm 45 x 50 mm
09-299-24 24 cm 45 x 60 mm
09-300-24 24 cm 45 x 75 mm
09-301-24 24 cm 65 x 85 mm



KOCHER

09-303-24 22 cm 70 x 25 mm
09-304-24 25 cm 80 x 42 mm
09-305-24 25 cm 80 x 50 mm
09-306-24 25 cm 80 x 60 mm



DOYEN-STILLE

09-308-24 24 cm 90 x 15 mm
09-309-24 24 cm 90 x 20 mm
09-310-24 25 cm 90 x 30 mm
09-311-24 24 cm 110 x 35 mm
09-312-24 24 cm 110 x 40 mm
09-313-24 24 cm 120 x 55 mm

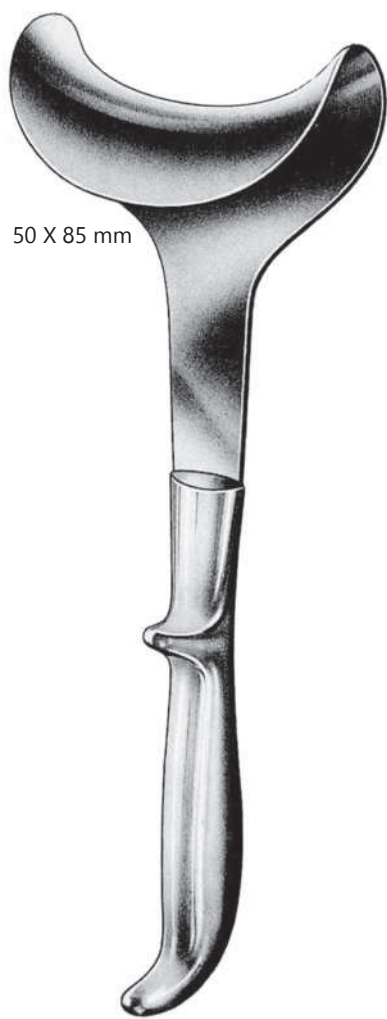
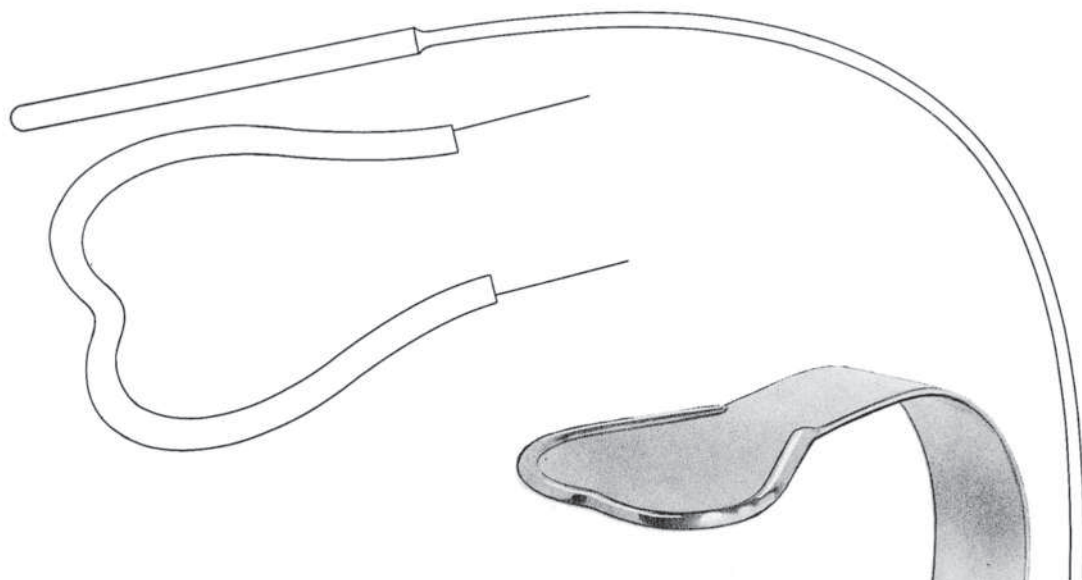

50 X 85 mm

DOYEN
09-315-25
25 cm



64 X 60 mm

TUFFIER
09-317-23
23 cm



HARRINGTON
09-319-32 32 cm 127 x 40 mm
09-320-32 32 cm 127 x 62 mm
09-321-32 32 cm 175 x 64 mm



90 X 50 mm

MIKULICZ
09-333-26
26 cm

MIKULICZ
09-325-26 26 cm 85 x 35 mm
09-326-26 26 cm 120 x 50 mm
09-327-26 26 cm 120 x 50 mm

KELLY
09-329-27 27 cm 160 x 38 mm
09-330-27 27 cm 160 x 57 mm
09-331-27 27 cm 190 x 38 mm
09-332-27 27 cm 190 x 57 mm





38 mm

DEAVER
09-336-30
30 cm



50 mm

DEAVER
09-348-30
30 cm



75 mm

DEAVER
09-350-30
30 cm



DEAVER

	L	B
09-352-30	30.5 cm	25 mm
09-353-33	33.0 cm	25 mm
09-354-30	30.5 cm	38 mm
09-355-30	30.5 cm	50 mm
09-356-30	30.5 cm	75 mm

KOERTE
09-358-28
28 cm

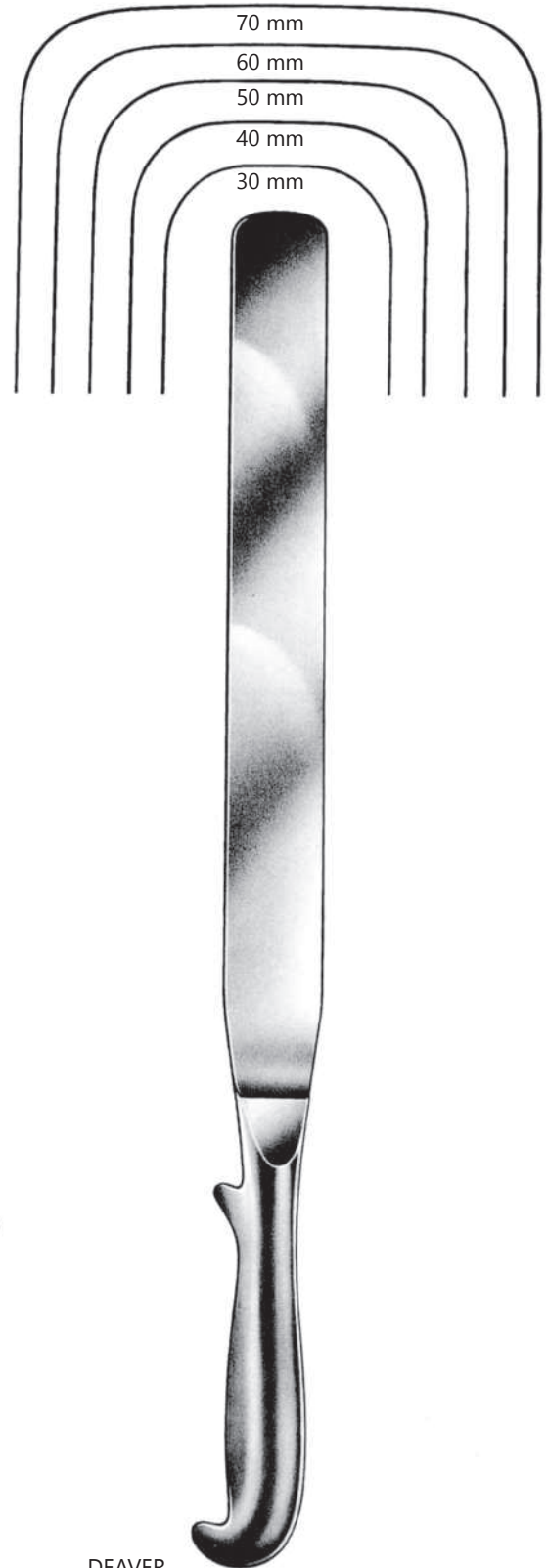

DEAVER

	L	B
09-360-41	41 cm	245 x 30 mm
09-361-41	41 cm	245 x 40 mm
09-362-41	41 cm	245 x 50 mm
09-363-41	41 cm	245 x 60 mm
09-364-41	41 cm	245 x 70 mm

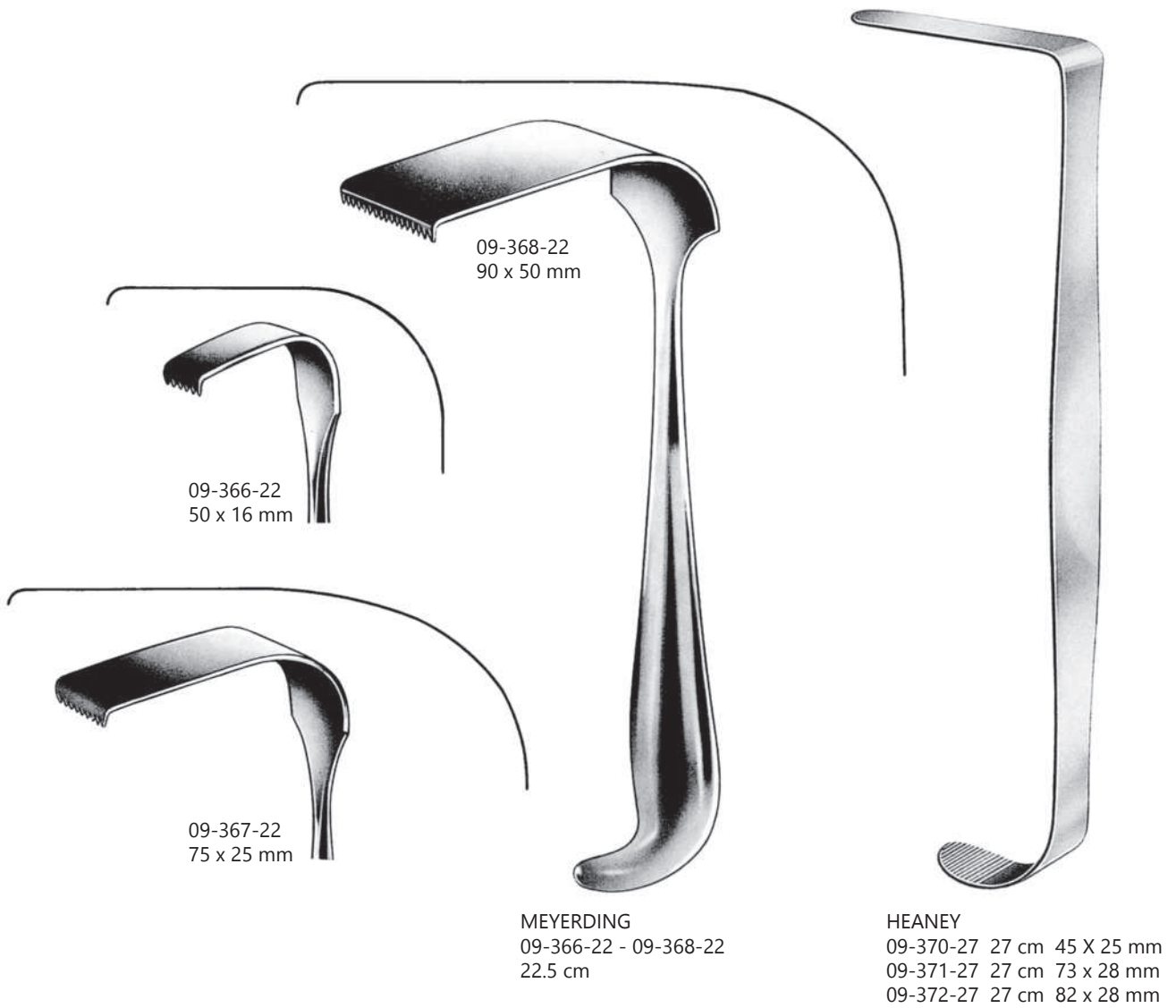



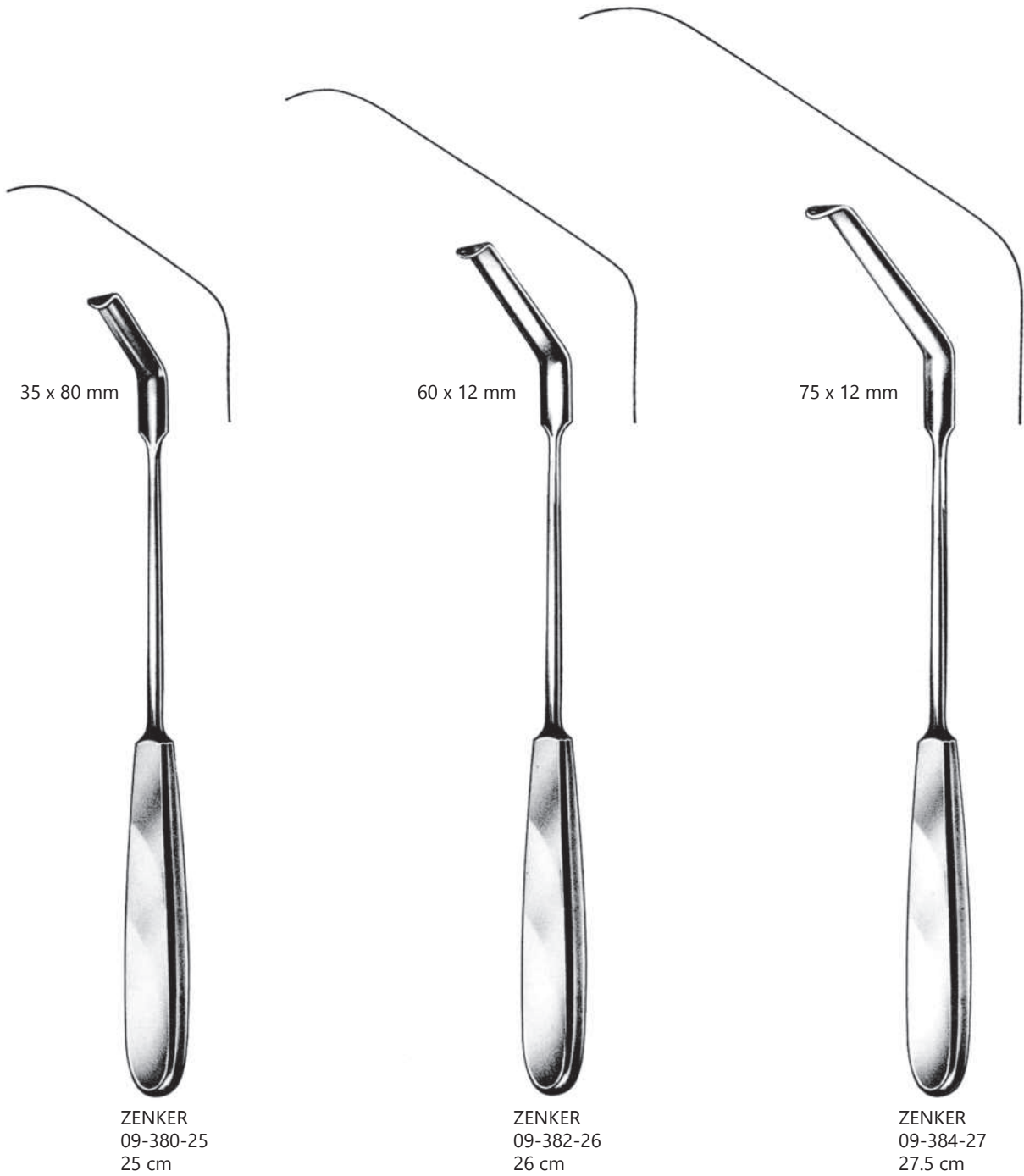

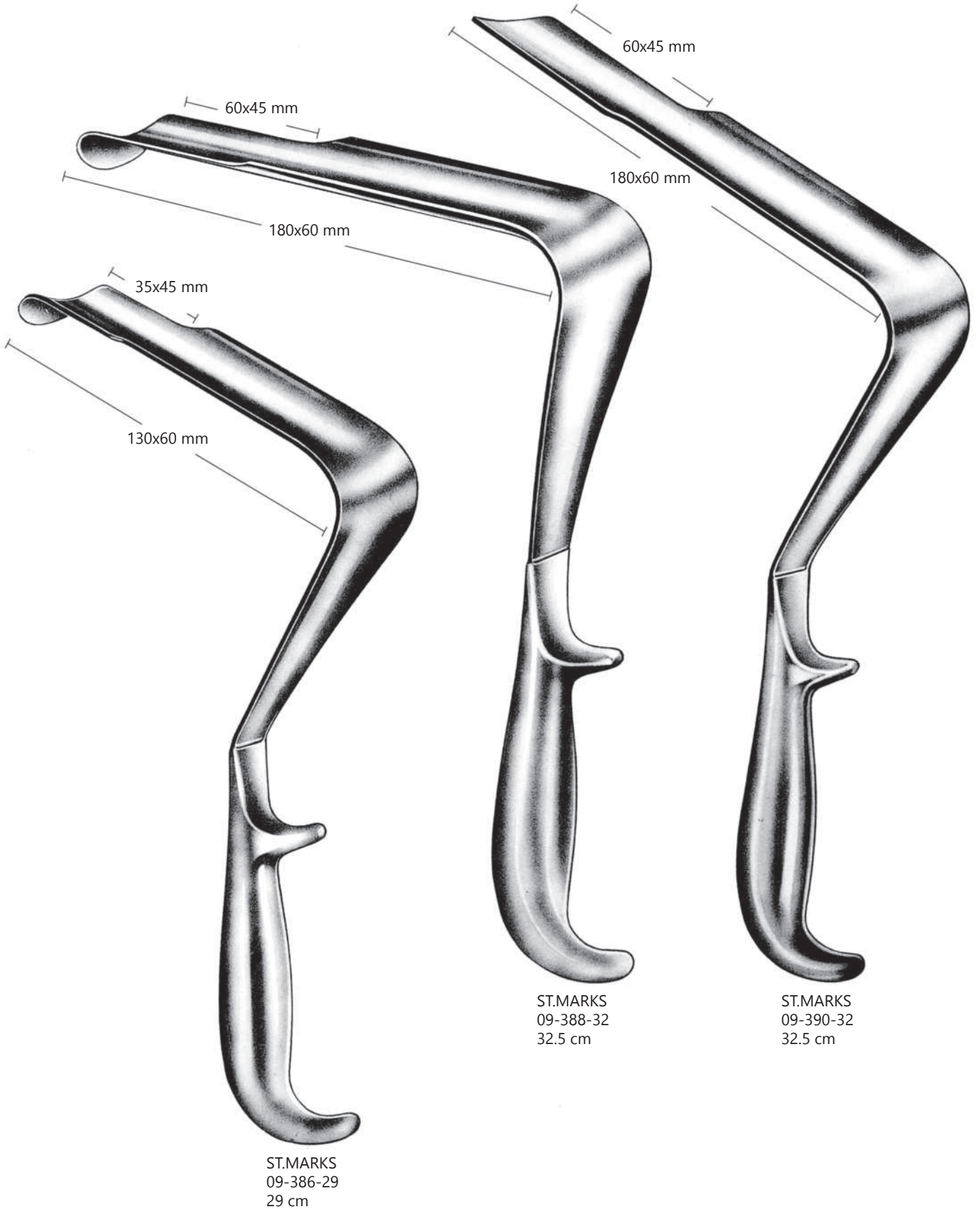



WEITLANER
09-392-10 10.5 cm
09-393-13 13.5 cm
sharp



WEITLANER
09-395-13 13 cm
sharp

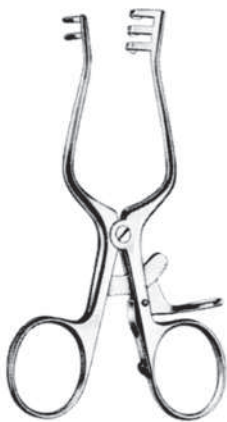

WEITLANER
09-397-10
10.5 cm
blunt



WEITLANER
09-399-13
13 cm
blunt



WEITLANER-BABY
09-401-14
14 cm



JANSEN
09-403-10 10 cm sharp
09-404-10 10 cm bunt



JANSEN
09-403-10 10 cm sharp
09-404-10 10 cm bunt



SNITMAN
09-409-10 10.5 cm sharp
09-410-10 10.5 cm bunt



MILLIGAN
09-412-13 13 cm sharp
09-413-13 13 cm blunt



MOLLISON
09-415-15 15 cm sharp
09-416-15 15 cm blunt



TRAVERS
09-418-21
21 cm



ANDERSON-ADSON
09-420-20 20 cm sharp
09-421-20 20 cm blunt



WULLSTEIN
09-423-10 10.5 cm sharp 09-427-10 10.5 cm blunt
09-424-13 13 cm sharp 09-428-13 13 cm blunt
09-425-16 16 cm sharp 09-429-16 16 cm blunt



SCHUKNECHT
09-431-14 14 cm sharp
09-432-14 14 cm blunt

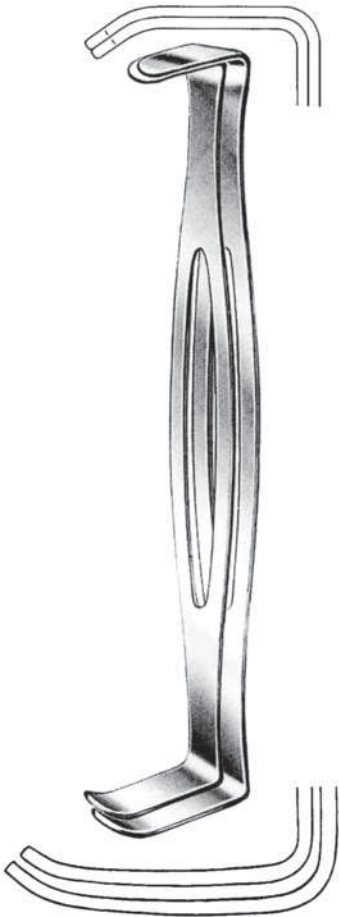

PARKER-LANGENBECK
09-434-21 21 cm



PARKER
09-436-18 18 cm



MATHIEU
09-438-20 20 cm



PARKER
09-442-13
13 cm



FARABEU
09-440-13
13 cm



GOELET
09-444-19
19 cm



FARABEU
09-446-15
15 cm



ROUX
09-448-16
16 cm
set of 3 piece

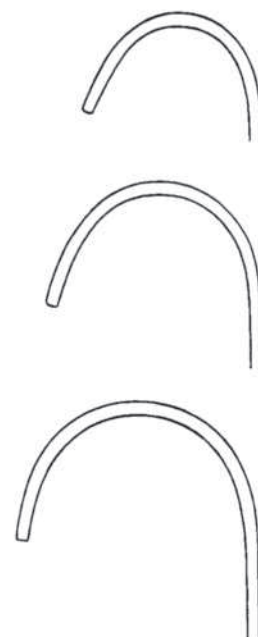



SCALP-CONTOUR
09-453-14 14 cm sharp
09-454-14 14 cm blunt

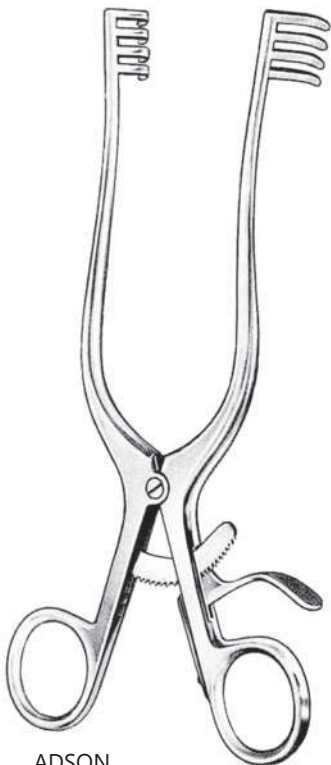

ADSON
09-456-20 20 cm sharp
09-457-20 20 cm blunt

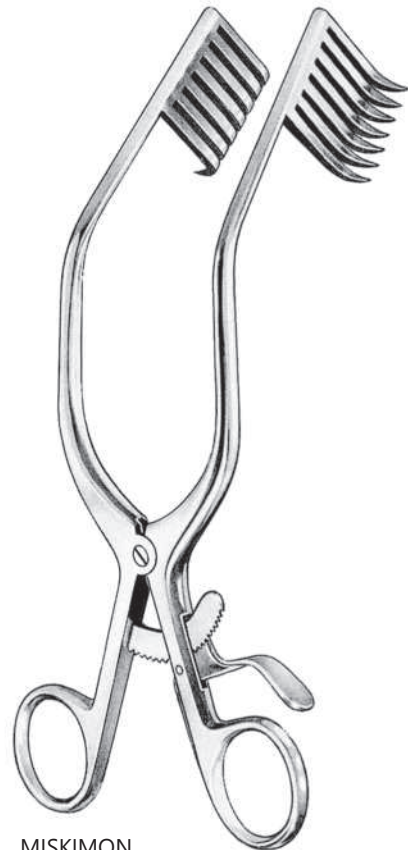

MISKIMON
09-459-22 22 cm sharp
09-460-22 22 cm blunt



PLESTER

09-462-10	10 cm	sharp	09-465-10	10 cm	blunt
09-463-13	13 cm	sharp	09-466-13	13 cm	blunt



PLESTER-R

09-468-10	10 cm	blunt
09-469-13	13 cm	blunt



PLESTER-L

09-471-10	10 cm	blunt
09-472-13	13 cm	blunt

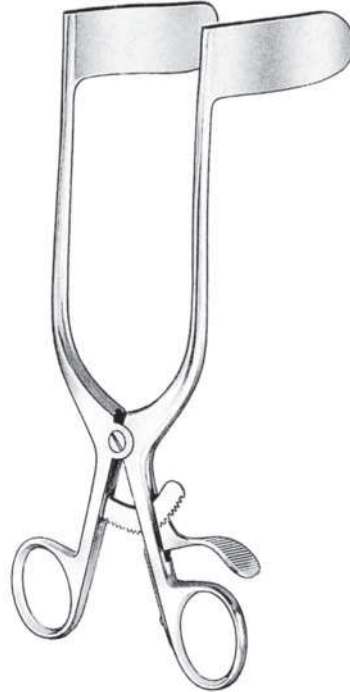

RIGHBY
09-474-18 18 cm 35 x 20 mm
09-475-18 18 cm 60 x 20 mm
09-476-18 18 cm 65 x 15 mm

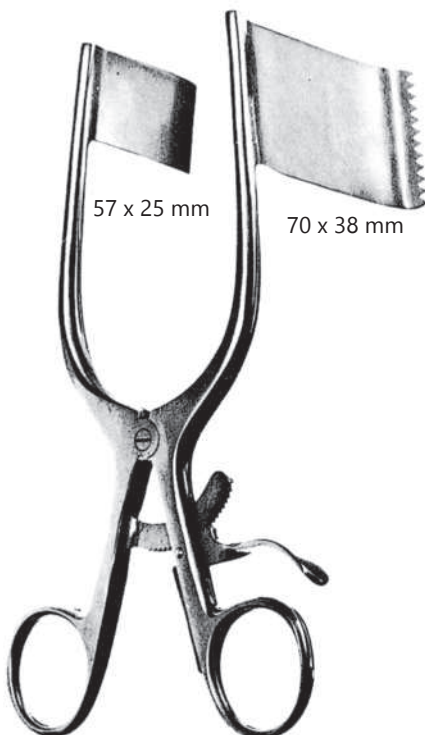

DARLING
09-478-18
18 cm

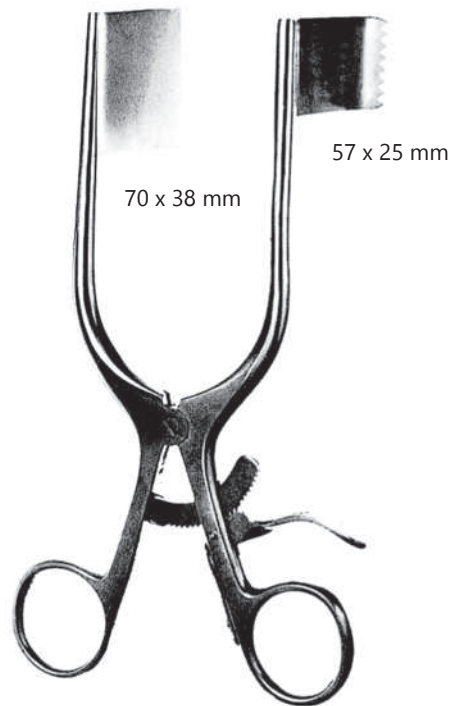

DARLING
09-480-18
18 cm



BECKMANN-EATON
09-482-33 33 cm sharp
09-483-33 33 cm blunt



GELPI
09-485-09 9 cm
09-486-11 11 cm
09-487-14 14 cm
09-488-19 19 cm



GELPI
09-490-19
19 cm



MEYERDING
09-492-20 20 cm 32 x 25 mm
09-493-20 20 cm 54 x 25 mm
09-494-20 20 cm 60 x 19 mm
09-495-20 20 cm 60 x 25 mm



MARKHAM-MEYERDING
09-497-18
18 cm



MARKHAM-MEYERDING
09-499-18
18 cm

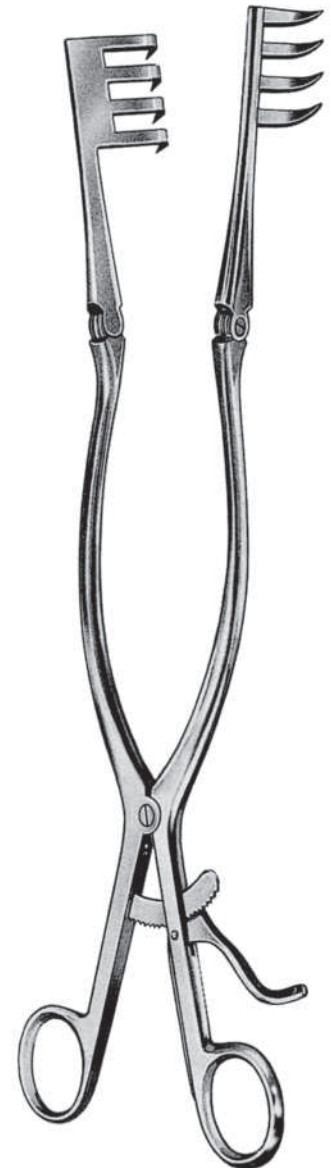
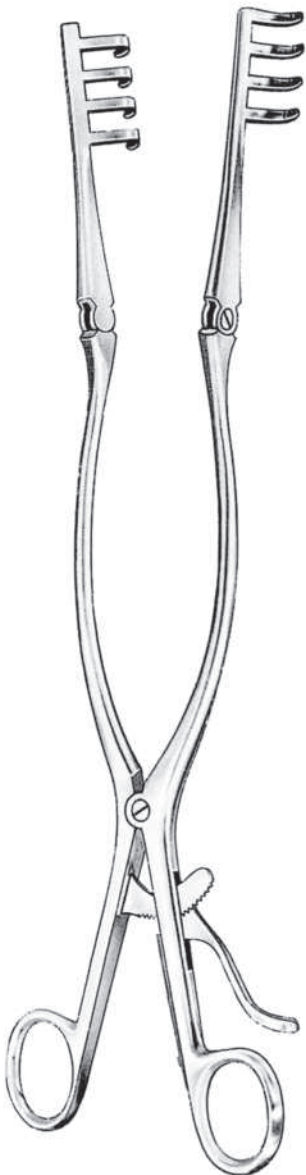

CONE

09-501-13	13 cm	09-505-13	13 cm
09-502-16	16.5 cm	09-506-16	16.5 cm
09-503-20	20 cm	09-507-20	20 cm
09-504-25	25 cm	09-508-25	25 cm

09-510-31	Sharp	09-512-31	31 cm	Blunt	4x4 teeth
09-511-33	Sharp	09-513-33	33 cm	Blunt	4x5 teeth

09-515-31	Sharp	09-519-31	31 cm	Blunt	25 x 25 mm
09-516-31	Sharp	09-520-31	31 cm	Blunt	25 x 30 mm
09-517-31	Sharp	09-521-31	31 cm	Blunt	25 x 40 mm
09-518-31	Sharp	09-522-31	31 cm	Blunt	25 x 45 mm

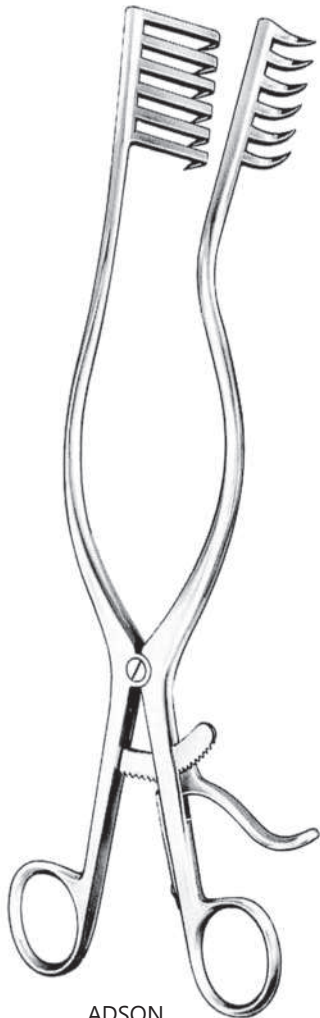

ADSON
09-524-27
27 cm

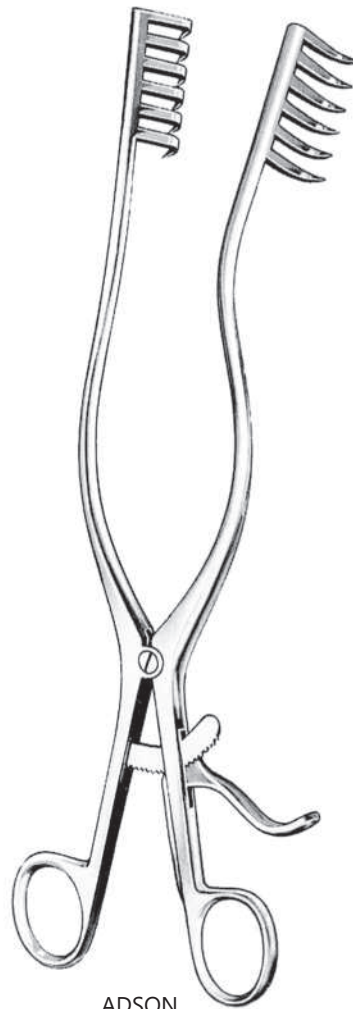

ADSON
09-526-27
27 cm

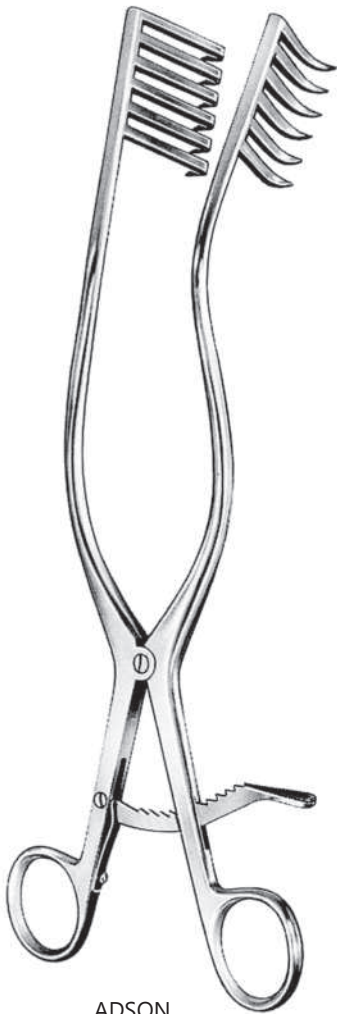

ADSON
09-528-27
27 cm

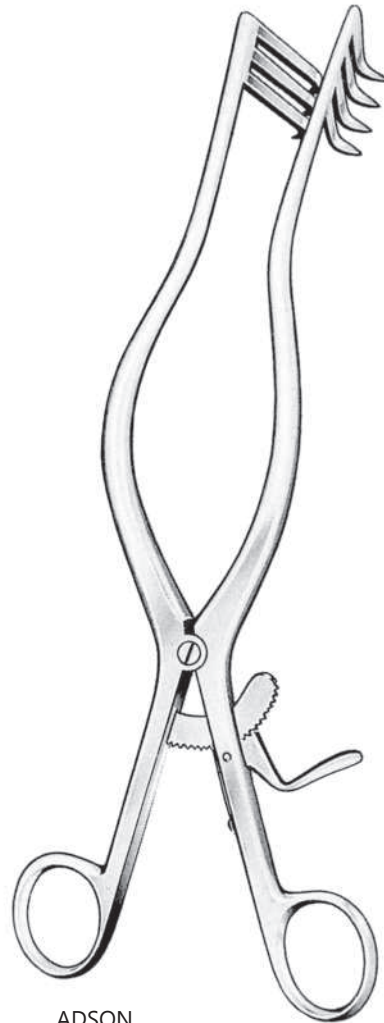

ADSON
09-530-27 27 cm sharp
09-531-27 27 cm blunt

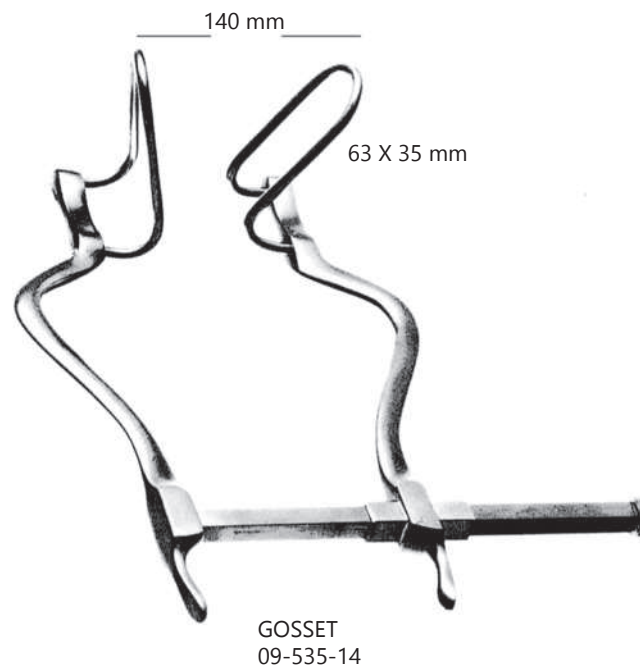
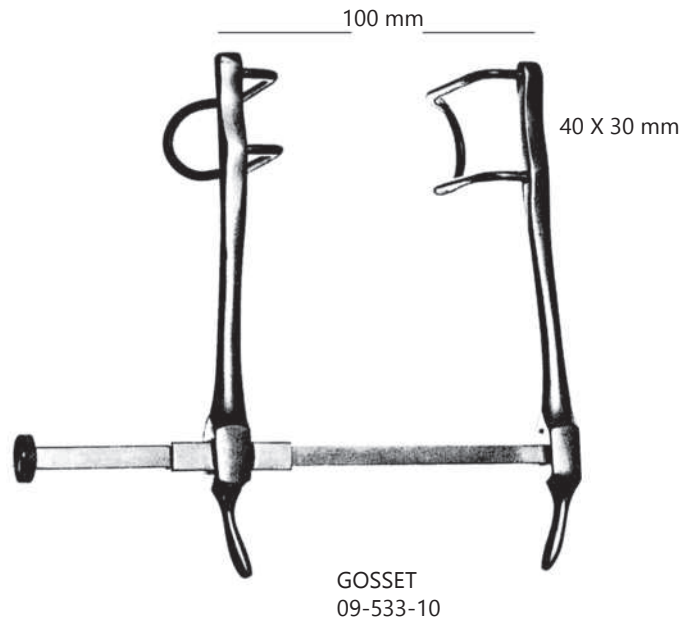

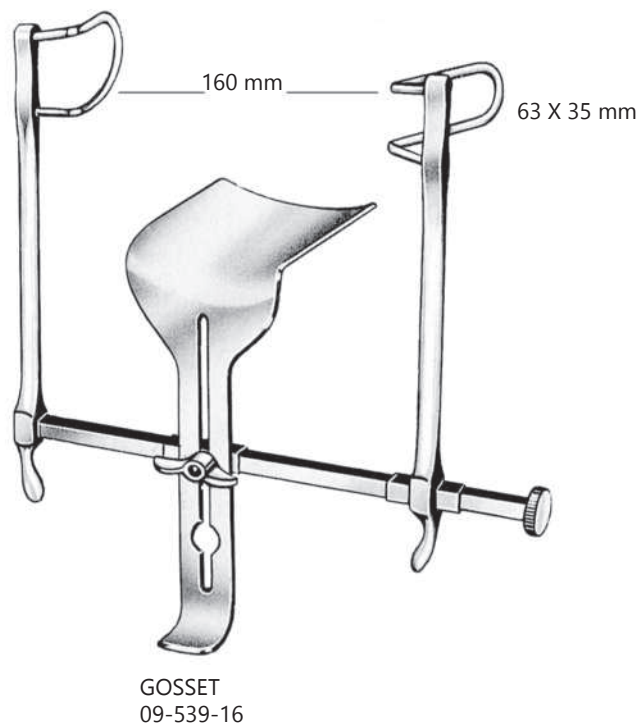
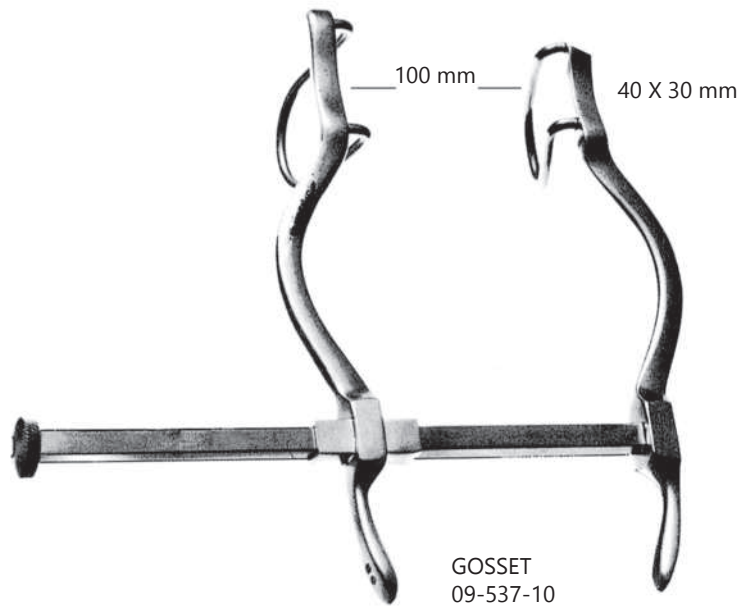

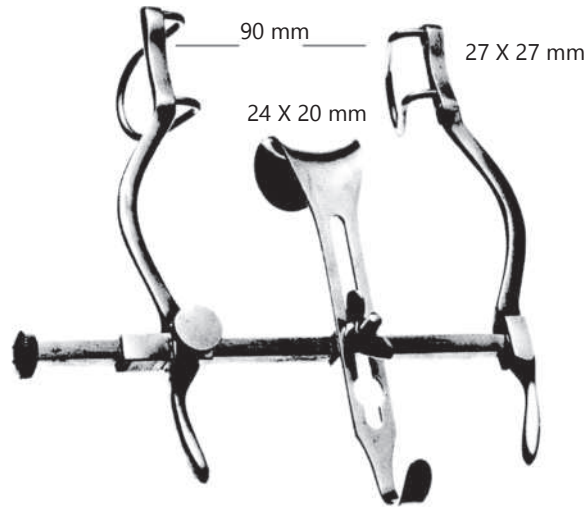

BALFOUR-BABY
09-541-09

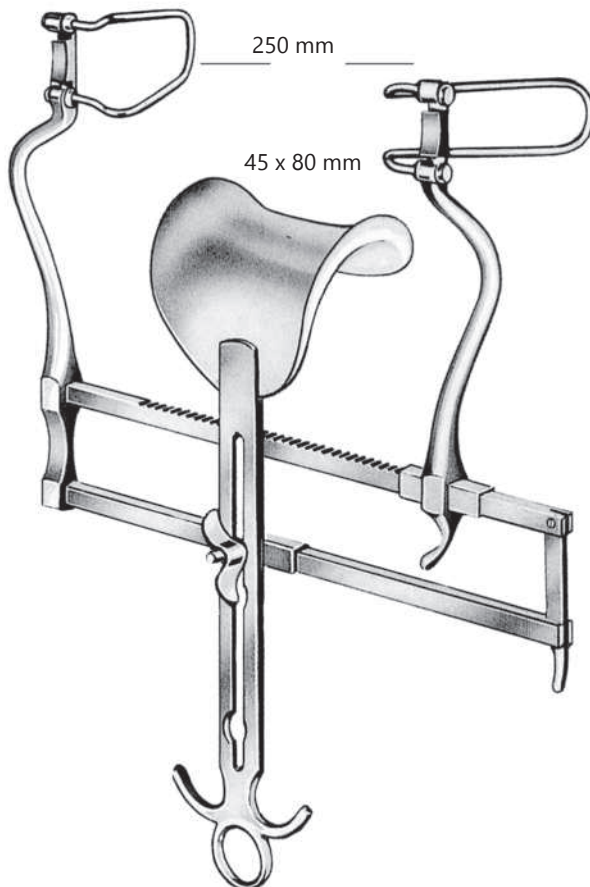

BALFOUR US-TYPE
09-543-00



09-545-01
70 x 35 mm



09-547-02
100 x 35 mm
complete with 2 pairs of blades



BALFOUR
09-549-01 45 X 80 mm
09-550-02 70 x 85 mm
centre blade only

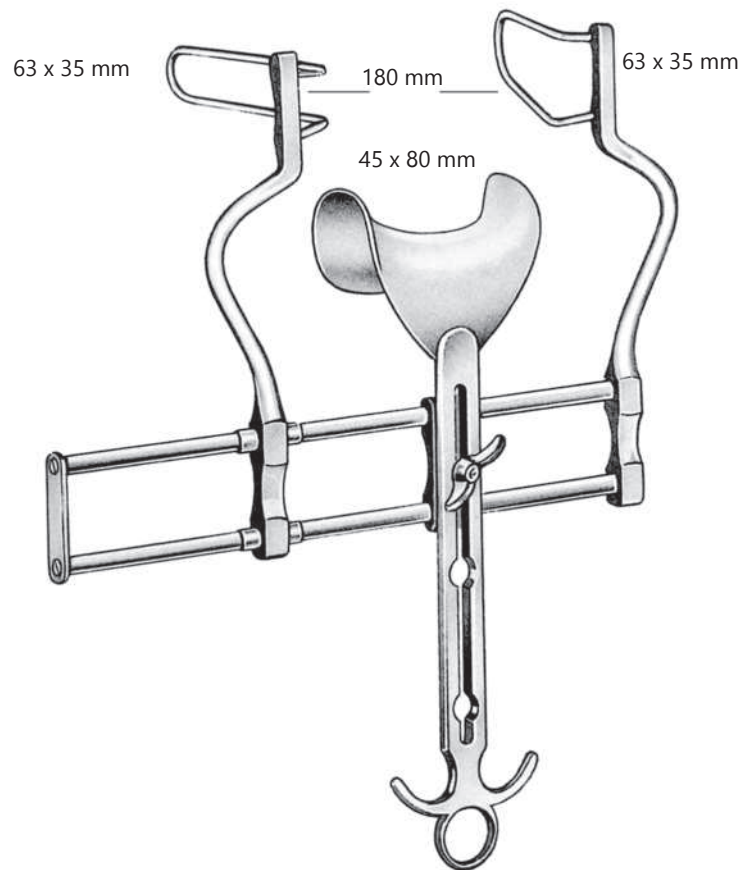

BALFOUR
09-5552-18
18 cm



BALFOUR
09-554-00 100 X 70 mm
centre blade only

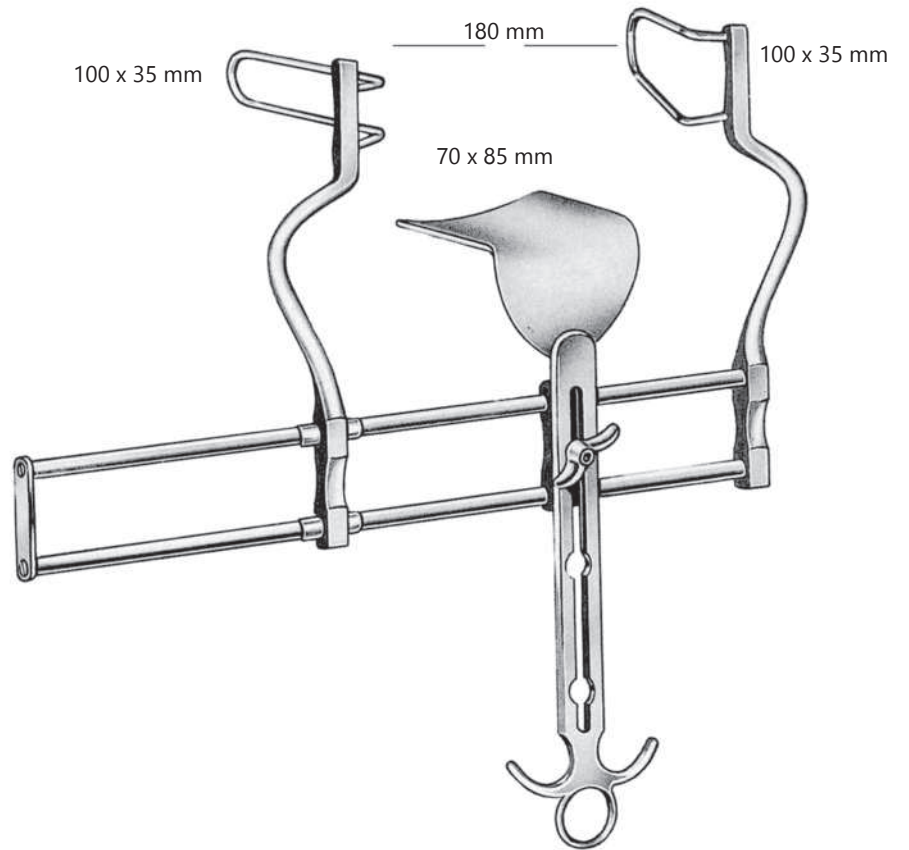

BALFOUR
09-556-20 20 cm -c
09-558-25 25 cm -c

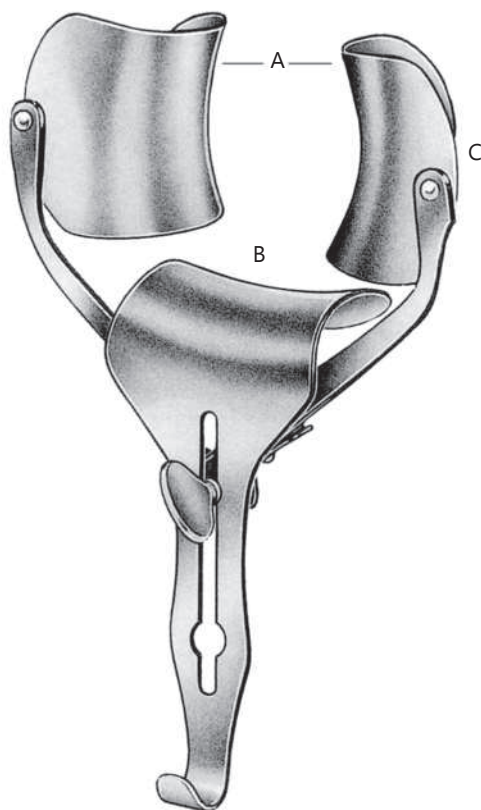

RICARDO	A	B	C
09-560-28	280 mm	80 x 90 mm	72 x 85 mm
09-561-30	300 mm	55 x 70 mm	60 x 80 mm

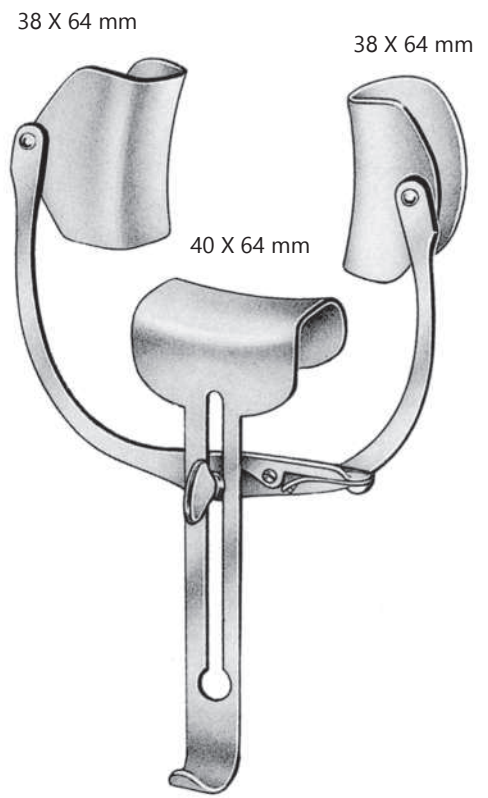

ROBIN - MASSE
09-563-00

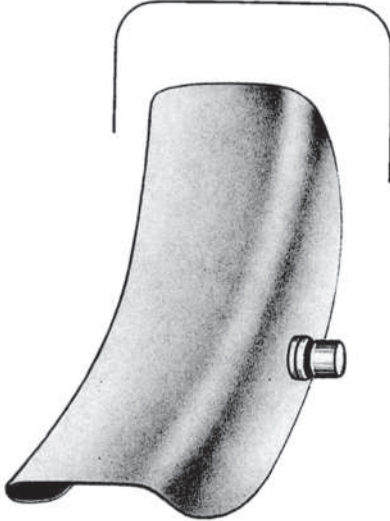

09-565-06 38 x 62 mm
09-566-08 38 x 80 mm
09-567-10 38 x 100 mm

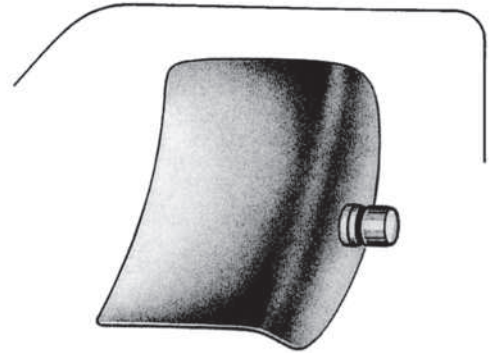

09-568-00 62 x 80 mm

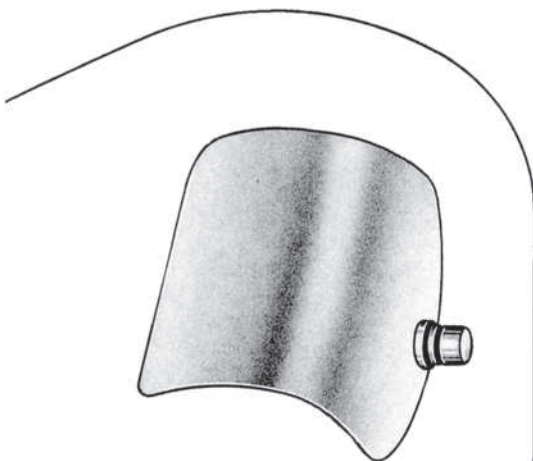

09-569-00 50 x 58 mm
09-570-01 60 x 80 mm
09-571-02 72 x 85 mm

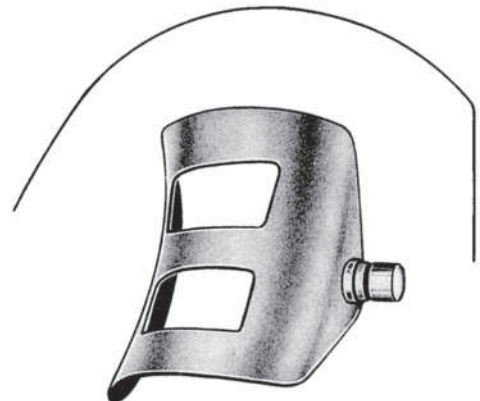

09-572-00 62 x 80 mm

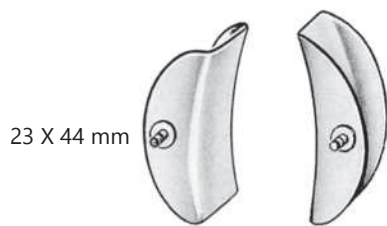

23 X 44 mm

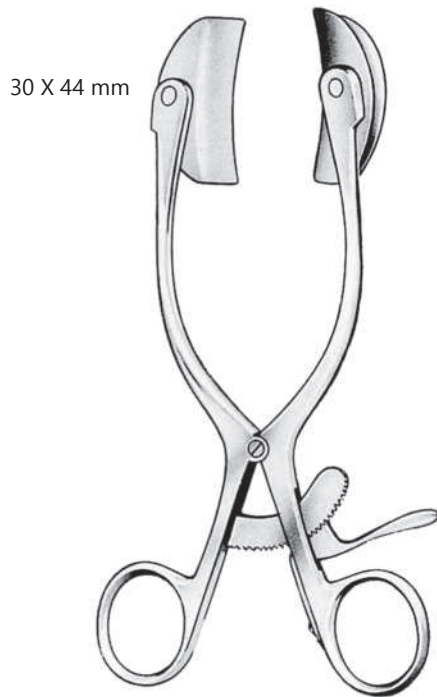

30 X 44 mm

COLLIN-BABY
09-573-18
18 cm
complete set with 2 pairs of blades

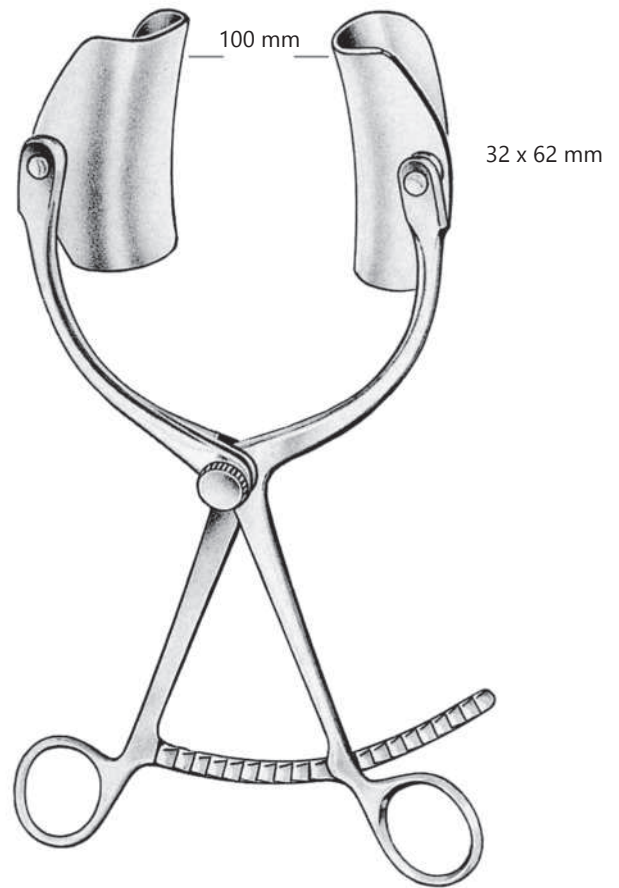

100 mm

32 x 62 mm

COLLIN
09-575-22
22 cm



COLLIN	A	B
09-577-12	55 x 55 mm	38 x 62 mm
09-578-12	55 x 65 mm	38 x 80 mm
09-579-12	55 x 75 mm	38 x 100 mm



COLLIN	A	B
09-581-16	62 x 67 mm	50 x 58 mm
09-582-16	62 x 67 mm	62 x 80 mm



10

Otology
Otologie
Otología



GRUBER
10-010-00 (Fig-2 - 4)
set of 3 pieces

Fig-1
10-011-01
4.5 mm Ø

Fig-2
10-012-02
5.5 mm Ø

Fig-3
10-013-03
6.5 mm Ø

Fig-4
10-014-04
7.5 mm Ø



GRUBER
10-016-05 (Fig-1 - 4)
set of 4 pieces



GRUBER
10-018-00 (Fig-2 - 4)
set of 3 pieces

Fig-1
10-019-01
3.5 x 4.5 mm

Fig-2
10-020-02
4.5 x 5.5 mm

Fig-3
10-021-03
5.5 x 6.5 mm

Fig-4
10-022-04
6.5 x 7.5 mm



GRUBER
10-027-05 (Fig-1 - 4)
set of 4 pieces

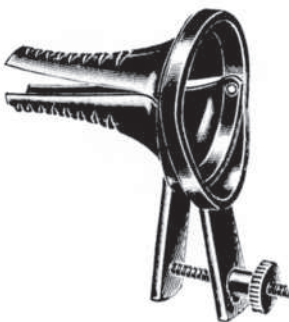

HOLMGRE
10-024-01 - 10-025-02

Fig-1
10-024-01
6 mm Ø

Fig-2
10-025-02
7 mm Ø



BOUCHERON
10-029-00 (Fig-1 - 4)
set of 4 pieces

Fig-1
10-030-01
4.5 mm Ø

Fig-2
10-031-02
5.5 mm Ø

Fig-3
10-032-03
6.5 mm Ø

Fig-4
10-033-04
7.5 mm Ø



ZOELLNER
10-035-00 (Fig-1 - 6)
set of 6 pieces



Fig-1
10-034-01
5.5 x 6.5 mm



Fig-2
10-07-02
8.5 x 7.5 mm



Fig-3
10-038-03
7.5 x 8.5 mm



Fig-4
10-039-04
8.5 x 9.5 mm



Fig-5
10-040-05
9.5 x 10.5 mm



Fig-6
10-041-06
10.5 x 11.5 mm



10-043-00 (Fig-1 - 6)
set of 6 pieces



Fig-1
10-044-01
2 mm Ø



Fig-2
10-045-02
3 mm Ø



Fig-3
10-046-03
4 mm Ø



Fig-4
10-047-03
5 mm Ø



Fig-5
10-048-05
6 mm Ø



Fig-6
10-049-06
7.5 mm Ø



Fig-1
10-052-01
3 mm Ø



Fig-1
10-057-04
6 mm Ø



Fig-1
10-062-01
4.5 mm Ø



Fig-2
10-053-02
4 mm Ø



Fig-2
10-058-05
7 mm Ø



Fig-2
10-063-02
5.5 mm Ø



Fig-3
10-054-03
5 mm Ø



Fig-3
10-059-06
8 mm Ø



Fig-3
10-064-03
5.5 mm Ø



TROELTSCH
10-051-00 (Fig-1 - 3)
set of 3 pieces



TROELTSCH
10-056-00 (Fig-1 - 3)
set of 3 pieces



ERHAROT
10-061-00 (Fig-1 - 3)
set of 3 pieces



RICHNAU0HOLMGREN
10-066-00 - 10-069-04

Fig-1
10-066-01
3 mm Ø

Fig-2
10-067-02
4 mm Ø

Fig-3
10-069-03
5 mm Ø

Fig-4
10-069-04
6 mm Ø



POLITZER
10-071-00 (Fig-1 - 3)
set of 3 pieces

Fig-1
10-072-01
3 mm Ø

Fig-2
10-072-02
4.5 mm Ø

Fig-3
10-074-03
5.5 mm Ø

Fig-4
10-075-04
6.5 mm Ø



POLITZER
10-077-00 (Fig-1 - 4)
set of 4 pieces



ZOELLNER
10-035-00 (Fig-1 - 6)
set of 6 pieces

Fig-1
10-080-01
2.5 mm Ø

Fig-2
10-081-02
4.5 mm Ø

Fig-3
10-083-03
5.0 mm Ø

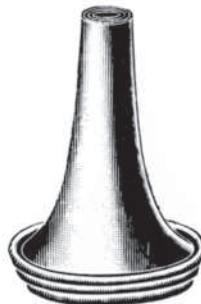

HARTMANN
10-084-00 (Fig-1 - 3)
set of 3 pieces

Fig-1
10-085-01
5.0 mm Ø

Fig-2
10-086-02
6.5 mm Ø

Fig-3
10-087-03
7.5 mm Ø



TOYNBEE
10-089-00 (Fig-1 - 3)
set of 3 pieces

Fig-1
10-091-03
4.0 mm Ø

Fig-2
10-092-02
5.0 mm Ø

Fig-3
10-094-03
6.0 mm Ø

Fig-4
10-095-04
7.0 mm Ø



TOYNBEE
10-096-00 (Fig-1 - 4)
set of 4 pieces



HARTMANN
10-098-00
C⁰-128



HARTMANN
10-100-00
C¹-256



HARTMANN
10-102-00
C²-512



HARTMANN
10-104-00
C³-1024



HARTMANN
10-106-00
C⁴-2048



HARTMANN
10-108-00
C⁴-4096



HARTMANN
10-110-00
C-64

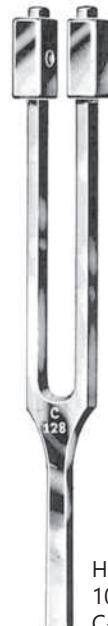

HARTMANN
10-112-00
C-128



HARTMANN
10-114-00
C¹-256



LUCAE
10-116-00
C⁰-128



LUCAE
10-118-00
C⁰-256



LUCAE
10-120-00
C⁰-512



LUCAE
10-122-00
C⁰-1024



LUCAE
10-124-00
C⁴-2048



LUCAE
10-126-00
C⁵-4096



LUCAE
10-128-00
a¹-435



ALU
10-130-00
C²-512



ALU
10-132-00
C³-1024



ALU
10-134-00
C⁴-2048



ALU
10-136-00
C⁵-4096



BARDON
10-138-00 Ø 1.0 x 75 mm
10-139-00 Ø 1.5 x 75 mm
10-140-00 Ø 2.0 x 75 mm



WULLSTEIN
10-142-16
16 cm 1.5mm Ø



WULLSTEIN
10-144-16 1.5 mm Ø
10-145-16 2.0 mm Ø



ROSEN
10-147-00 Ø 0.70 x 80 mm
10-148-00 Ø 0.90 x 80 mm
10-149-00 Ø 1.2 x 80 mm



ROSEN
10-151-00 Ø 0.70 x 65 mm
10-152-00 Ø 0.90 x 65 mm
10-153-00 Ø 1.2 x 65 mm



ZOLLNER
10-155-00 0.5 mm Ø
10-156-00 0.7 mm Ø



ZOLLNER
10-158-00
0.7 mm Ø



POLITZER
 10-160-00



POLITZER(Royce)
 10-162-16
 16 cm



LUCAE(Royce)
 10-164-18
 18 cm



LUCAE(Royce)
 10-166-18
 18 cm



10-168-15
Fig-1

10-169-15
Fig-2

10-170-15
Fig-3

BILLEAU
 10-168-15 - 10-170-15
 15.5 cm



10-172-16
Fig-00 2.0 mm

10-173-16
Fig-0 2.5 mm

10-174-16
Fig-1 3.0 mm

BILLEAU-MICRO
 10-172-16 - 10-174-16
 16 cm



WAGENER
 10-176-14 - 10-179-14
 14 cm



10-176-14
2.0 mm



10-177-14
2.5 mm



10-178-14
3.0 mm



10-179-14
3.5 mm



WAGENER
 10-181-14 - 10-182-14
 14 cm



10-181-14
sharp



10-182-14
blunt



SHAPLEIGH
 10-184-14 - 10-185-14
 14 cm

10-184-14
Fig-1

10-185-14
Fig-2



MOLDENHAUER
 10-187-16
 16 cm



DAY
 10-189-16 - 10-190-16
 16 cm

10-189-15

10-190-16



GROSS
 10-192-12
 12 cm
 sharp/blunt



GROSS
 10-194-12
 12 cm
 blunt/blunt



GARDINER-BROWN
 10-196-14
 14 cm

Fig-0000
 1.5 mm

Fig-000
 2 mm

Fig-00
 2.2 mm

Fig-0
 2.7 mm

Fig-1
 3.2 mm



10-198-16 Fig-0000
 10-199-16 Fig-000
 10-200-16 Fig-00
 10-201-16 Fig-0
 10-202-16 Fig-1
 16 cm
 sharp



BUCK-WULLSTEIN
 10-204-16 Fig-0000
 10-205-16 Fig-000
 10-206-16 Fig-00
 10-207-16 Fig-0
 10-208-16 Fig-1
 16 cm
 blunt

Fig-00
 2.2 mm

Fig-00
 2.5 mm

Fig-1
 3 mm

Fig-2
 4 mm

Fig-3
 4.5 mm



BUCK
 10-210-15 Fig-00
 10-211-15 Fig-0
 10-212-15 Fig-1
 10-213-15 Fig-2
 10-214-15 Fig-3
 15 cm
 sharp



BUCK
 10-216-15 Fig-00
 10-217-15 Fig-0
 10-218-15 Fig-1
 10-219-15 Fig-2
 10-220-15 Fig-3
 15 cm
 blunt



WULLSTEIN
10-233-26
26 cm



YANKAUER-JANSEN
10-222-15
15 cm



JANSEN
10-224-15 - 10-225-15
15 cm



ALLPORT
10-227-16
16 cm



HARTMANN
10-229-16 - 10-231-16
16 cm



LEMPERT
10-235-15
15 cm



LEMPERT
10-237-15
15 cm



LEMPERT
10-239-14
15 cm



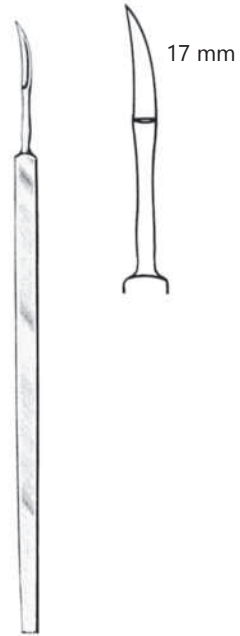

LEMPERT
10-241-16
16 cm

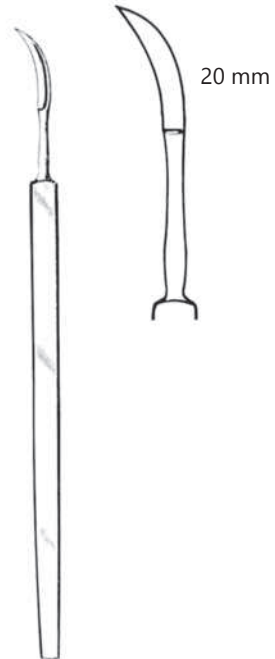

LEMPERT
10-243-17
17 cm

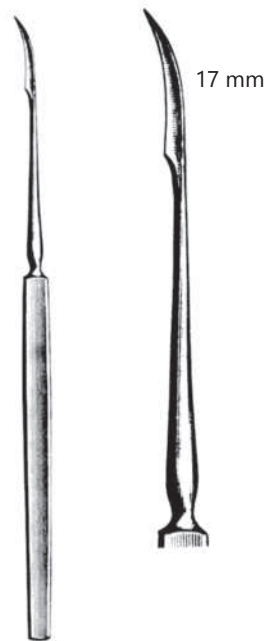

POLITZER
10-245-16
16 cm

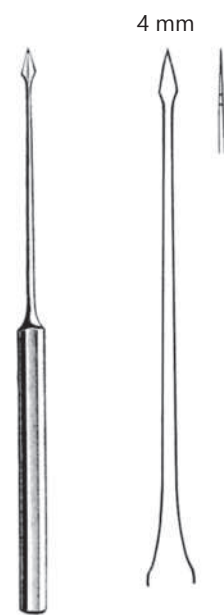

BUCK
10-247-15
15 cm



HARTMANN
10-249-00

HARTMANN
10-251-00



10-253-00 50 ml
 10-254-04 100 ml
 Ear syringe, complete



YANKAUER
10-256-28
Tonsil Suction Tube
with central boring



FRAZIER
(Fergusson)
10-258-00 Ø 1.0 x 190 mm
10-259-00 Ø 2.0 x 190 mm



QUIRE
 10-261-00
 10 cm



BUCK
 10-263-00
 11 cm



HARTMANN
 10-265-13
 13 cm

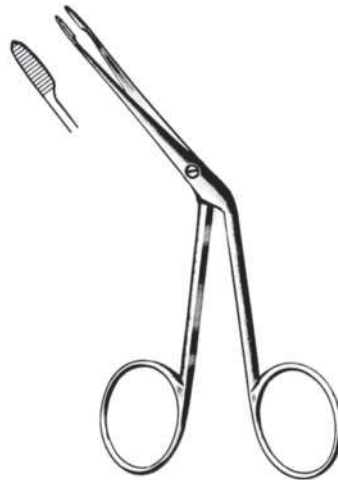

HARTMANN
 10-267-13
 13 cm



LITTAUER
 10-269-13
 13 cm

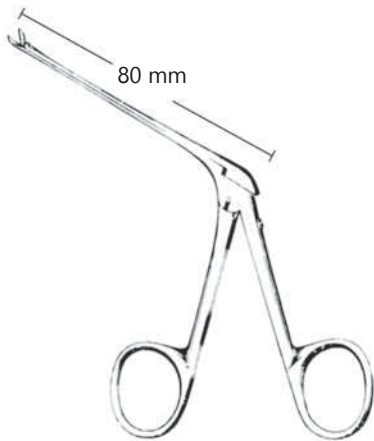

BELLUCCI
10-271-11 - 10-275-17



10-271-11
sharp - blunt - straight



10-272-12
sharp - sharp - straight



10-273-13
sharp angles upwards



10-274-16
sharp, curved to right



10-275-17
sharp, curved to left

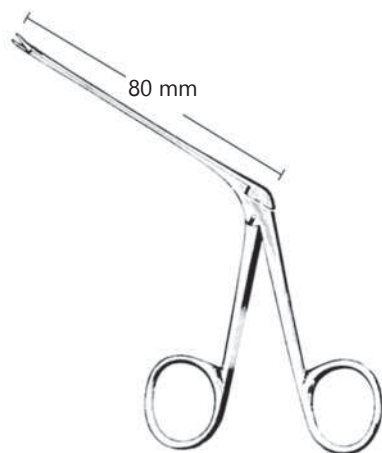

SHEA-BELLUCCI
10-277-10 - 10-280-17



10-277-10
blunt - blunt -straight



10-278-12
sharp - sharp - straight



10-279-16
semi - sharp, bent to right



10-280-17
semi - sharp, bent to left

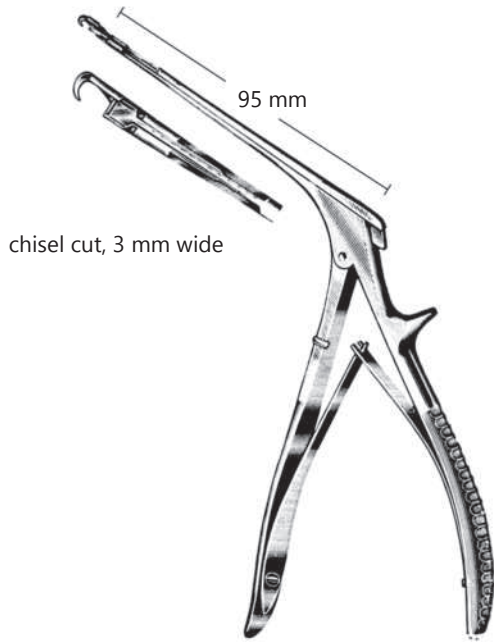

LEMPERT
 10-282-00

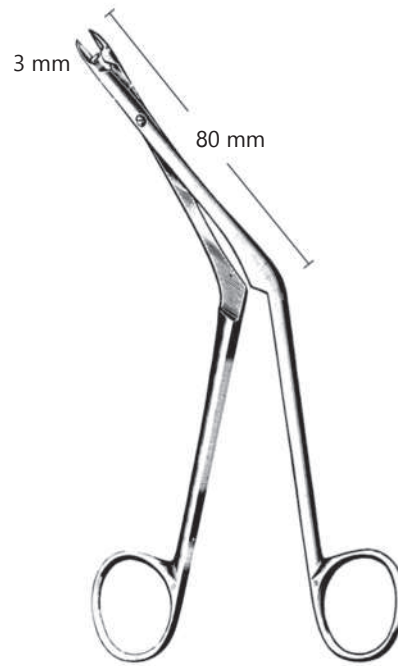

WULLSTEIN
 10-284-00
 chisel cut, 3 mm long

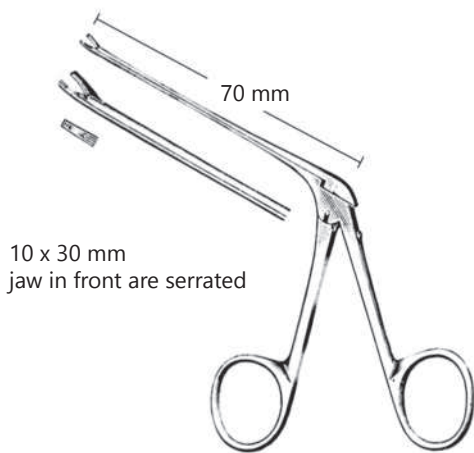

GREVEN
 10-286-00

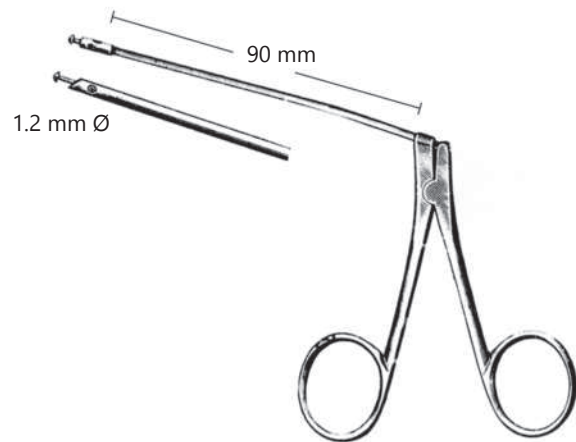

MEHMKE
 10-288-00

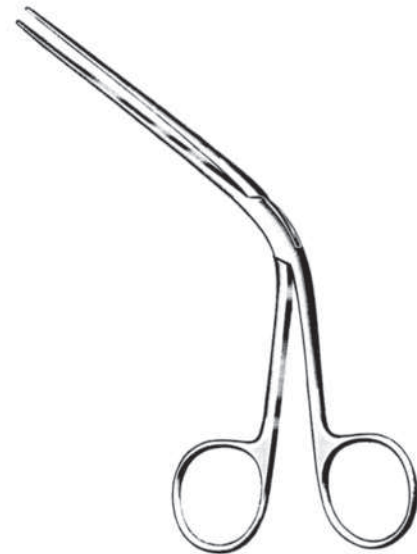
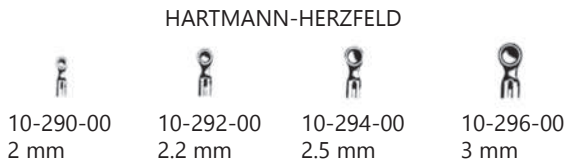

TILLEY
10-298-14
14 cm
serrated jaws 65 mm long

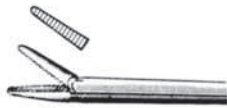

HARTMANN
10-300-12
serrated jaws



WEINGARTNER
10-310-00
concave serrated

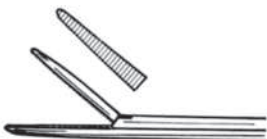
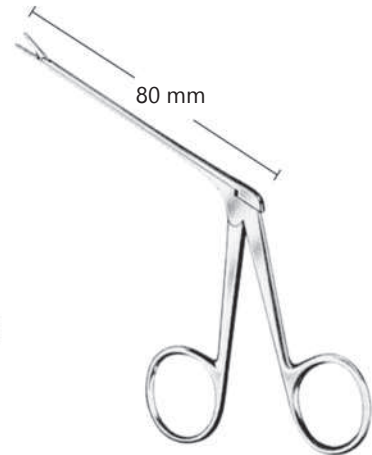

HARTMANN-NOYES
10-302-00
2.5 x 5 mm
serrated



ENTENSCHNABEL
10-308-00
2 mm
wide



HARTMANN
10-304-00
1 x 2 mm teeth
serrated



HARTMANN-HEAZFELD
10-312-00
round spoon shape jaws



HARTMANN
10-306-00
2 x 7 mm
spoon shaped jaws



STRUEMPEL
10-314-00
2.5 x 5 mm
pointed oval spoon jaws

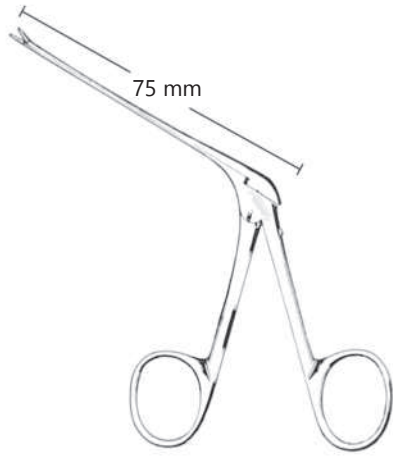

HARTMANN
 10-316-00 - 10-318-00



10-316-00
 1.2 mm
 smooth



10-318-00
 1.2 mm
 1 x 2 teeth
 smooth

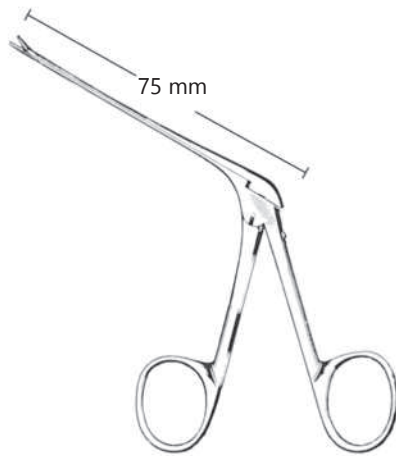

HARTMANN
 10-320-00 - 10-321-00

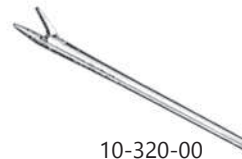

10-320-00
 serrated



10-321-00
 serrated jaw angled upward

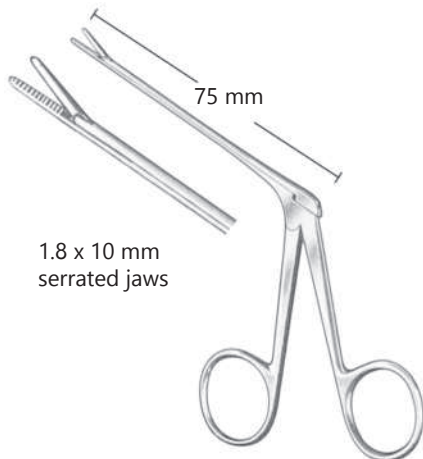

1.8 x 10 mm
 serrated jaws

BELLUCCI
 10-322-00

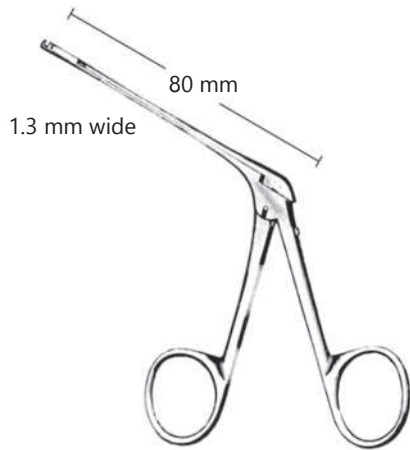

DIETER
10-323-00 - 10-326-00



10-323-00
cutting to right



10-324-00
cutting to left



10-325-00
upward cutting



10-326-00
downwards cutting

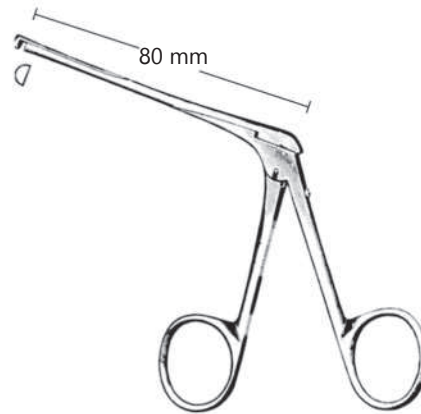

DAVAL
10-328-00

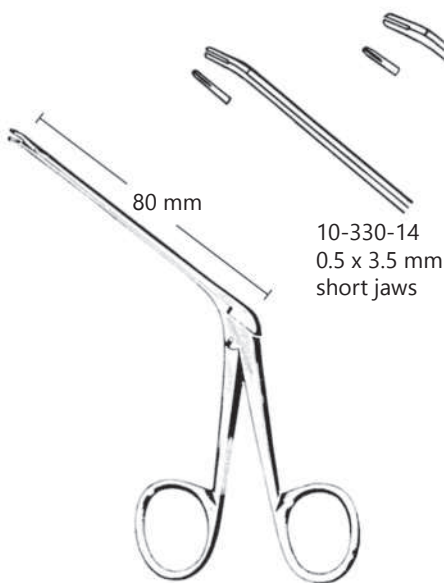

MCGEE
10-330-14 - 10-331-15

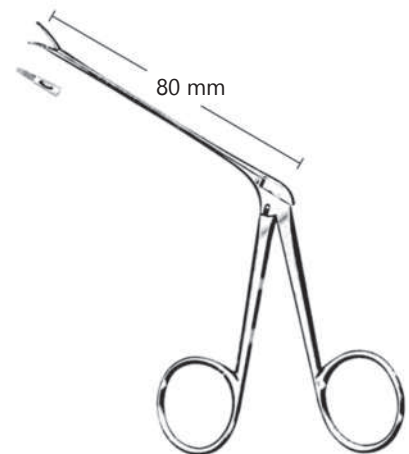

SCHUKNECHT
10-333-00
0.5 x 6 mm
jaws slightly bent downwards

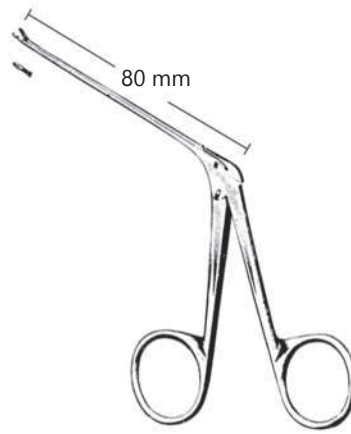
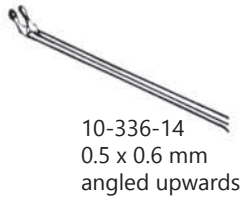

SUPER FINE
10-335-12 - 10-338-17
spoon forceps

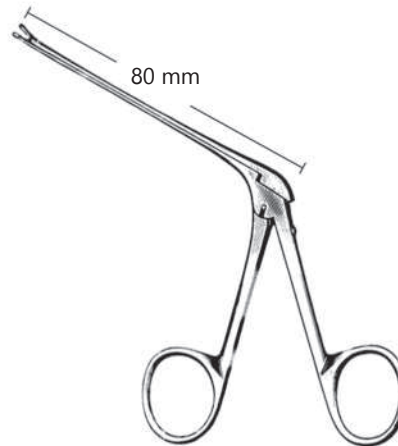

10-340-12 - 10-343-17
spoon forceps

80 mm

80 mm

0.4 x 4 mm
serrated

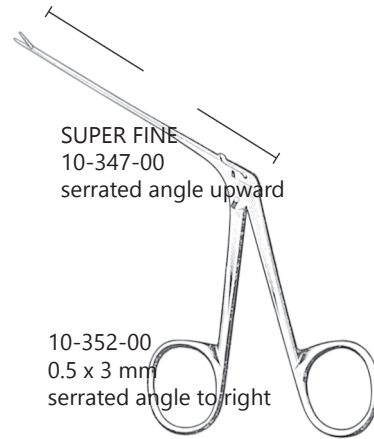
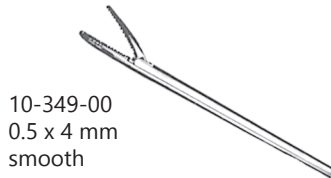
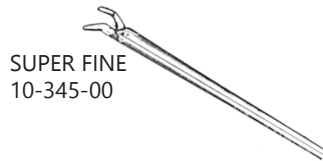

80 mm

10-350-00
0.5 x 4 mm
serrated

10-353-00
0.5 x 3 mm
angle to left

10-351-00
0.5 x 3 mm
serrated angled upwards

10-354-00
0.5 x 8 mm
serrated extra long

10-349-00 - 10-354-00



11

Rhinology
Rhinologie
Rinología

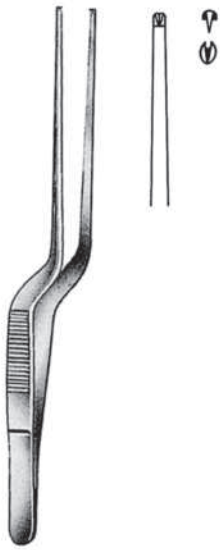

LUCAE 1:2
11-010-14
14 cm

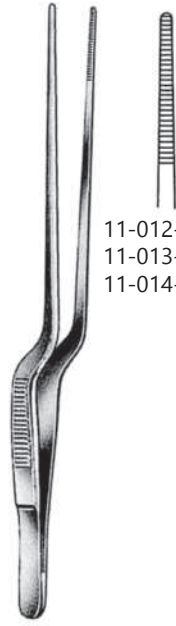

11-012-16 16 cm
11-013-18 18 cm
11-014-20 20 cm

JANSEN
11-012-16 - 11-014-20



LUCAE
11-016-14
14 cm

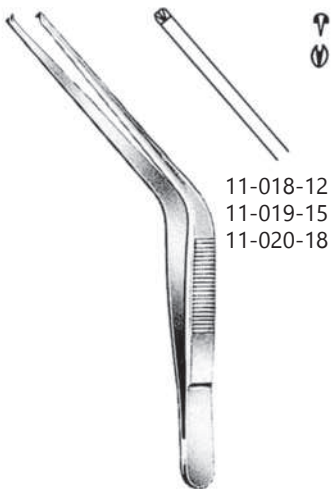

11-018-12 12 cm
11-019-15 15 cm
11-020-18 18 cm

TROELTSCH (WILDE) 1:2
11-018-12 - 11-020-18

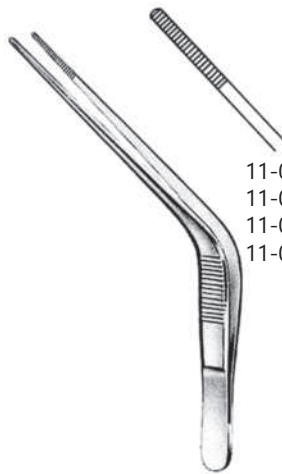

11-022-11 11 cm
11-023-12 12 cm
11-024-15 15 cm
11-025-18 18 cm

TROELTSCH (WILDE)
11-022-11 - 11-025-18



11-027-11 11 cm
11-023-13 13 cm

TROELTSCH (WILDE)
11-027-11 - 11-028-13

3.5 mm
wide



KILLIAN
 11-030-18
 18 cm
 sharp / blunt

5.0 mm
wide

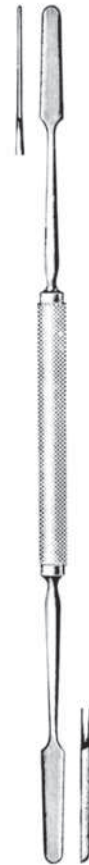

KILLIAN
 11-032-23
 23 cm

7.0 mm
wide



HAJEK-BALLENGER
11-034-20
20 cm



HOWARTH
11-036-21
21 cm



KISTNER
 11-038-17 - 11-039-17
 17 cm

11-038-17 11-039-17

6 mm
 wide



PENNINGTON
 11-041-20
 20 cm

6.5 mm
 wide



PIERCE
 11-043-20
 20 cm



LANGE
 11-045-23
 23 cm



BECKMANN
11-047-01 - 11-052-06
20 cm



11-047-01



11-048-02



11-049-03



11-050-04



11-051-05



11-052-06



NEGUS KNOT PUSHER
11-054-00
20 cm



GWYNNE EVANS DISSECTOR
11-056-00
8 mm x 20 cm
serrated



TOENNIS-ADSON
11-058-17
17.5 cm

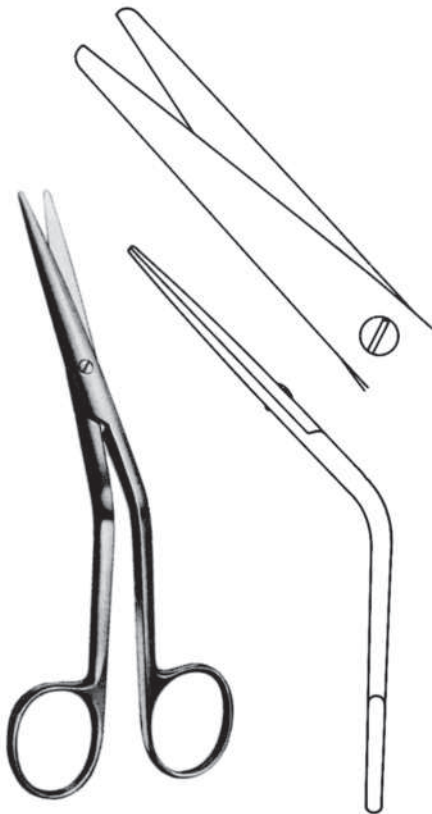

COTTLE
11-060-16
16 cm



FOMON
11-062-15
15 cm



BALLENGER
 11-064-01 3 mm Fig-1
 11-065-02 4 mm Fig-2
 11-066-03 5 mm Fig-3
 19 cm



Fig-1
 3 mm



Fig-2
 4 mm



Fig-3
 5 mm



BALLENGER
 11-068-01 3 mm Fig-1
 11-069-02 4 mm Fig-2
 11-070-03 5 mm Fig-3
 20 cm



HEYMANN
 11-072-17
 17 cm

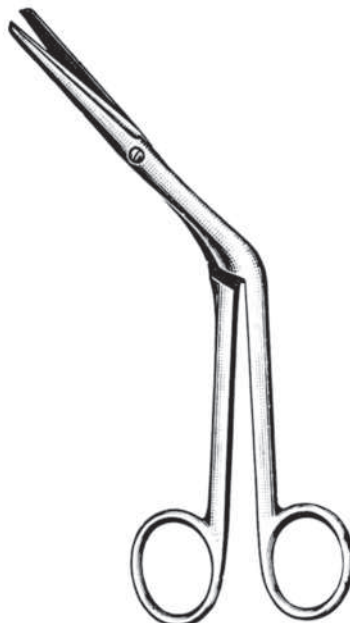

HEYMANN
 11-074-17
 17 cm

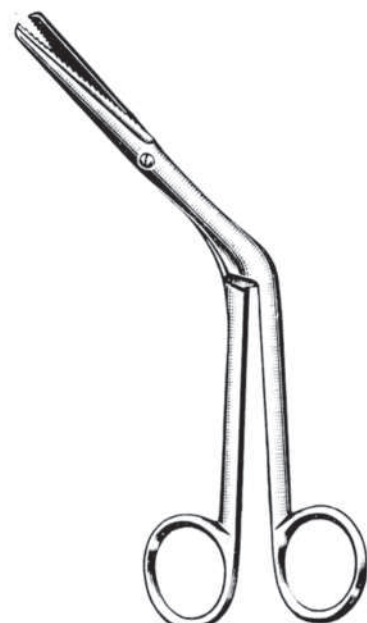

SEILER
 11-076-17
 17 cm

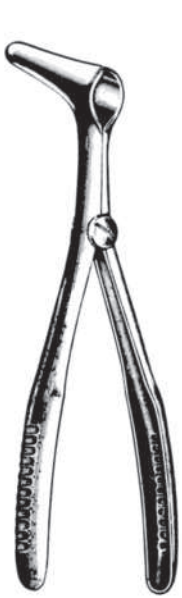

WALTON-VIENNA
11-078-14
14 cm



WIENNA MODEL
11-080-01 Fig-1
11-081-02 Fig-2
11-082-03 Fig-3
15 cm

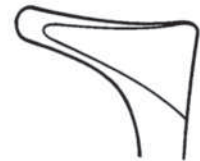

Fig. 1

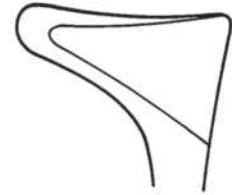

Fig. 2

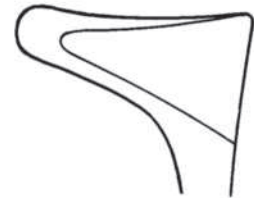

Fig. 3



WIENNA MODEL
11-084-01 Fig-1
11-085-02 Fig-2
11-086-03 Fig-3
14 cm

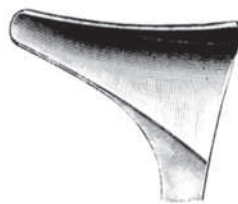

Fig. 1

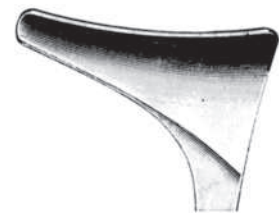

Fig. 2

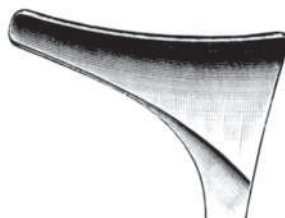

Fig. 3



BECKMANN
11-088-01 Fig-1
11-089-02 Fig-2
11-090-03 Fig-3
11-091-04 Fig-4
15 cm



Fig. 1



Fig. 2



Fig. 3



Fig. 4



WIENR MODEL
11-093-01 Fig-1
11-094-02 Fig-2
13 cm



Fig. 1



Fig. 2

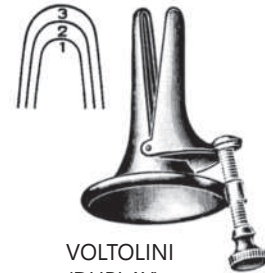

VOLTOLINI
(DUPLAY)
11-096-01 Fig-1
11-097-02 Fig-2
11-098-03 Fig-3
15 cm



FRAENKEL
11-100-08
8 cm



HARTMANN-HALLE
11-102-01 Fig-1
11-103-02 Fig-2
11-104-03 Fig-3
15 cm

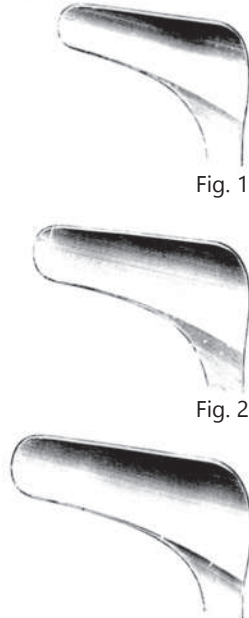

Fig. 1
Fig. 2
Fig. 3



HARTMANN-HALLE
11-106-01 Fig-1
11-107-02 Fig-2
11-108-03 Fig-3
15 cm



TIECK-HALLE
11-110-01 Fig-1
11-111-02 Fig-2
13.5 cm

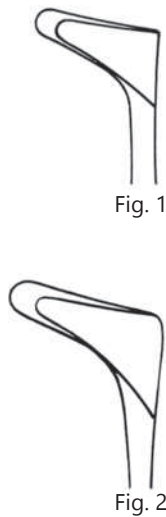

Fig. 1
Fig. 2



HARTMANN
11-113-01 Fig-1
11-114-02 Fig-2
11-115-03 Fig-3
15 cm

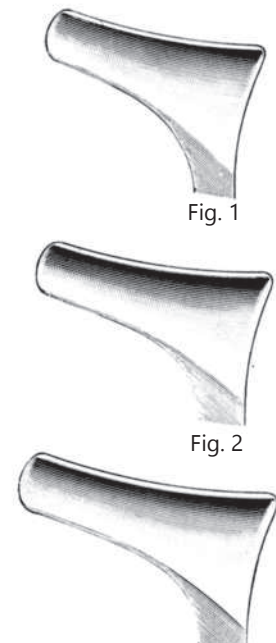
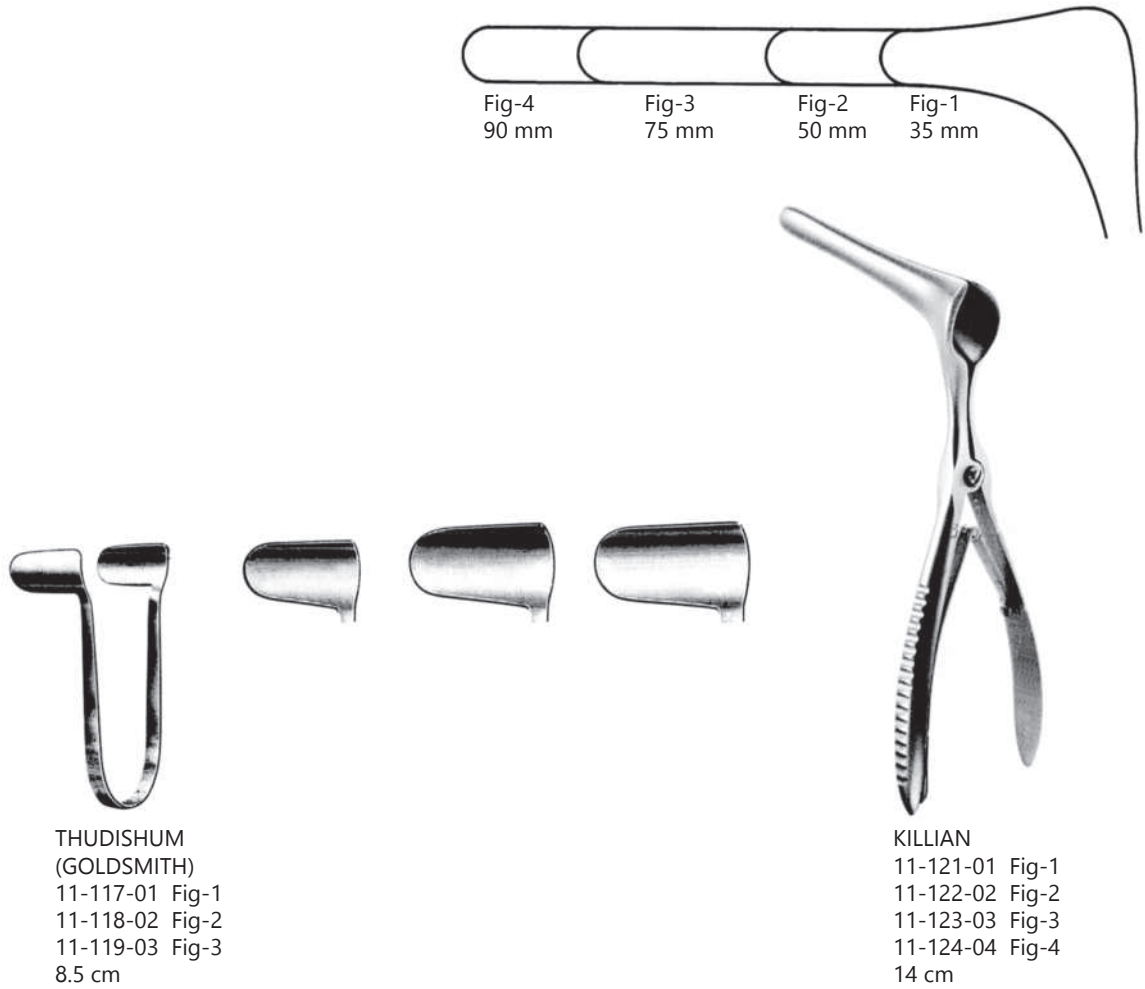
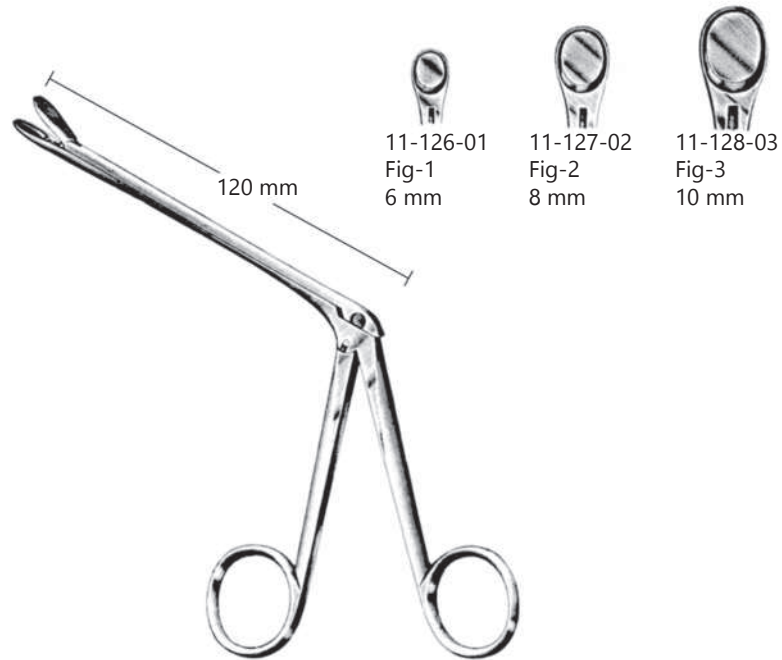

Fig. 1
Fig. 2
Fig. 3



THUDISHUM
(GOLDSMITH)
11-117-01 Fig-1
11-118-02 Fig-2
11-119-03 Fig-3
8.5 cm

KILLIAN
11-121-01 Fig-1
11-122-02 Fig-2
11-123-03 Fig-3
11-124-04 Fig-4
14 cm



WATSON-WILLIAMS
 11-126-01 - 11-128-03

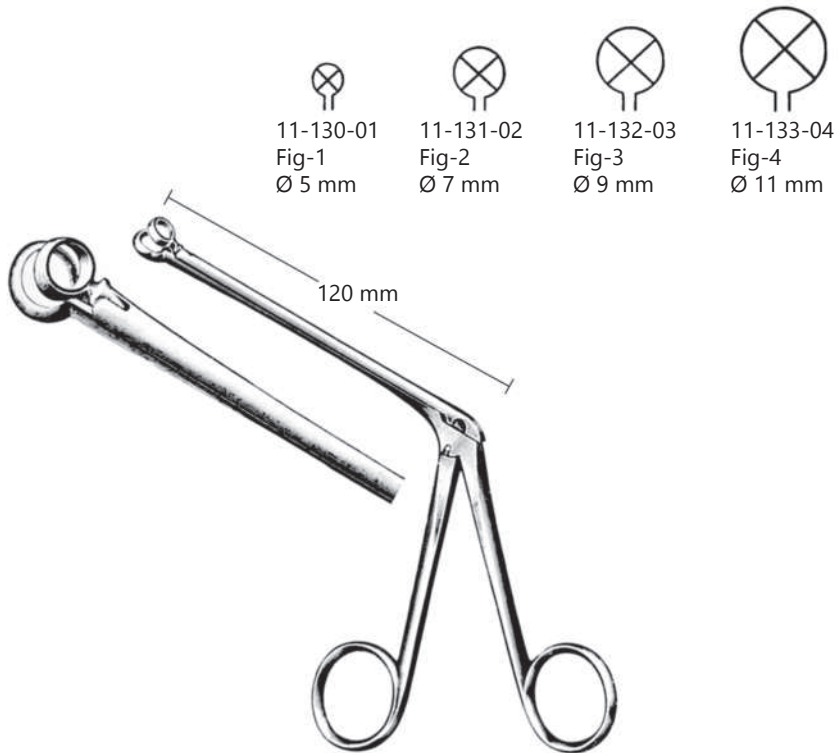

HARTMANN
 11-130-01 - 11-133-04



WEIL-BLAKESLEY
11-135-01 - 11-138-04

11-135-01
3.5 mm
Fig-1

11-136-02
4 mm
Fig-2

11-137-03
4.5 mm
Fig-3

11-138-04
5.5 mm
Fig-4

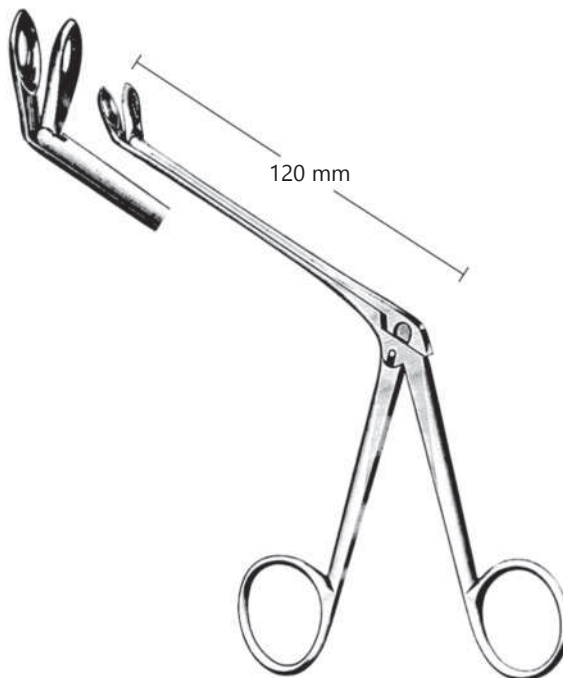

WEIL-BLAKESLEY
11-140-01 - 11-143-04

11-140-01
3.5 mm
Fig-1

11-141-02
4 mm
Fig-2

11-142-03
4.5 mm
Fig-3

11-143-04
5.5 mm
Fig-4

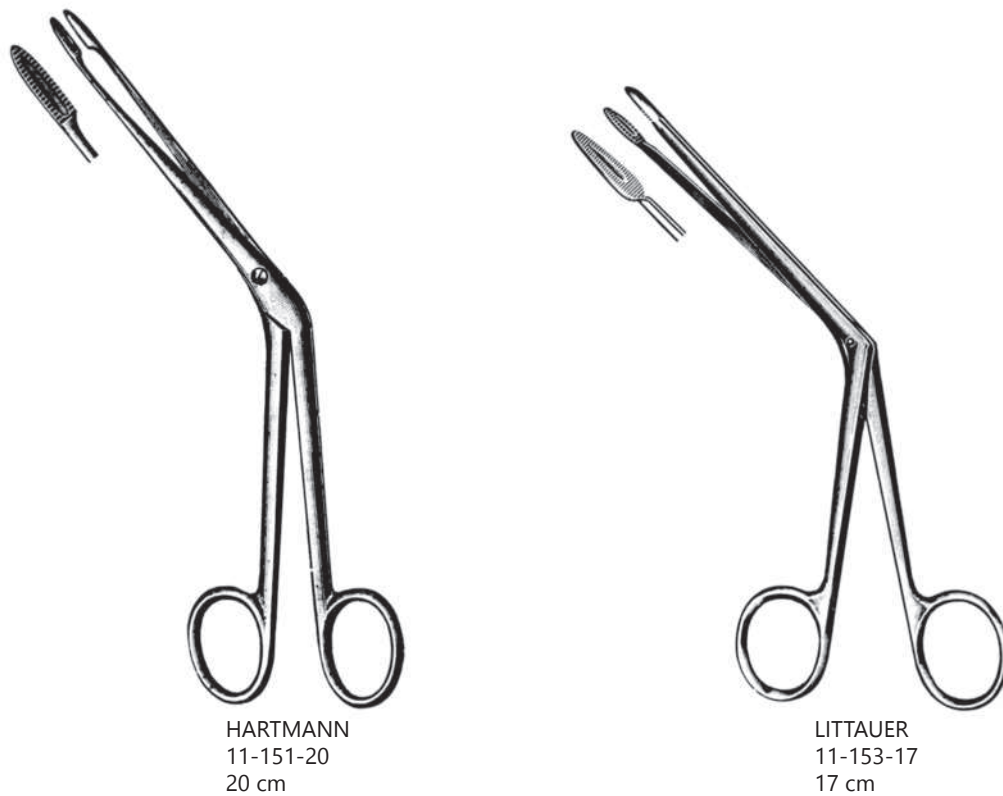
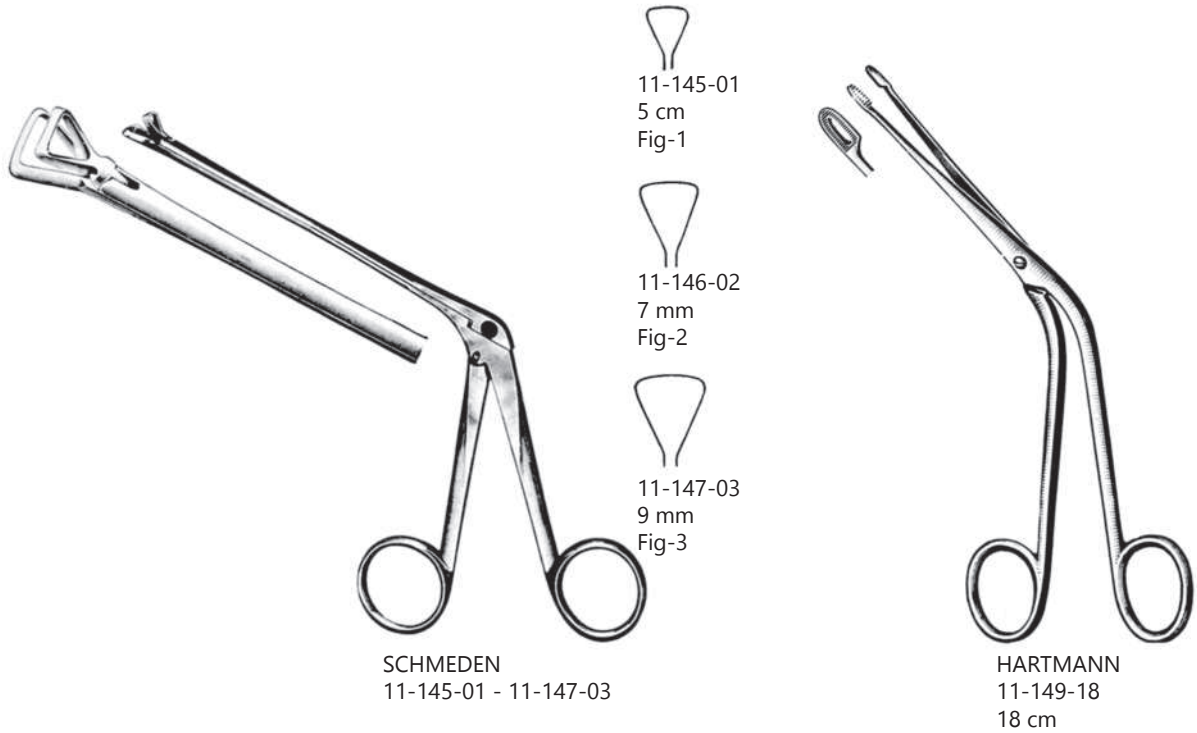

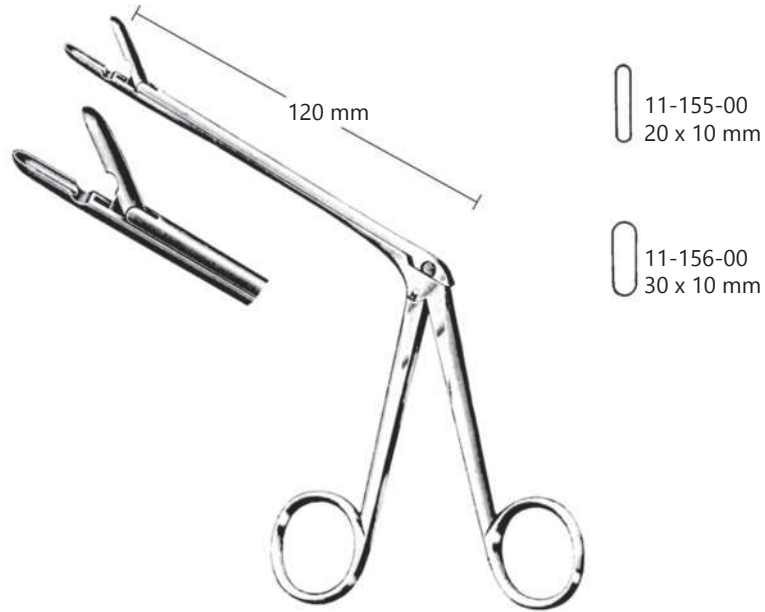

11-155-00
20 x 10 mm

11-156-00
30 x 10 mm

TAKAHASHI
11-155-00 - 11-156-00



WESTACOT
11-158-20
20 cm

WESTACOT
11-160-20
20 cm
fine model



LUBET-BARBON
11-162-20
20 cm

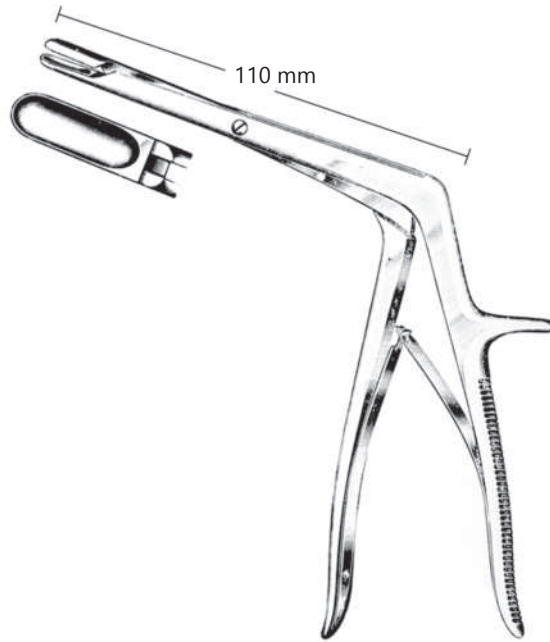

KOFLER
 11-164-00



JANSEN-MIDDLETON
 11-166-19
 19 cm



JANSEN-MIDDLETON
 11-168-19
 19 cm

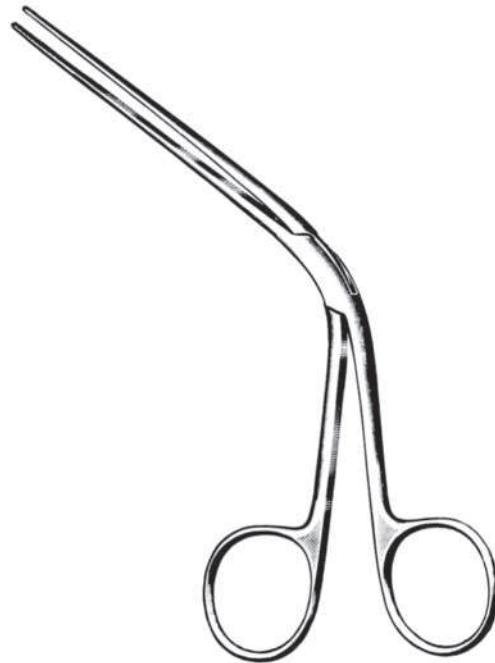

TILLEY
11-170-17
17 cm



NOYES
11-172-00



NOYES
11-174-00
1 x 2 teeth

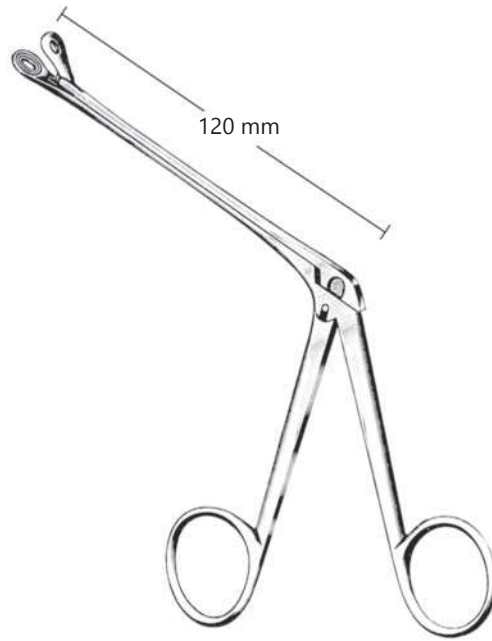

BLAKESLEY
 (Lewis)
 11-176-00 - 11-178-00

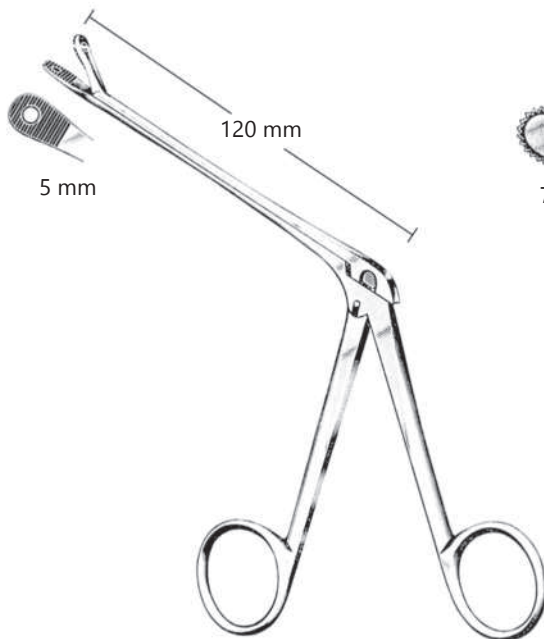

FERRIS-SMITH
 11-180-00

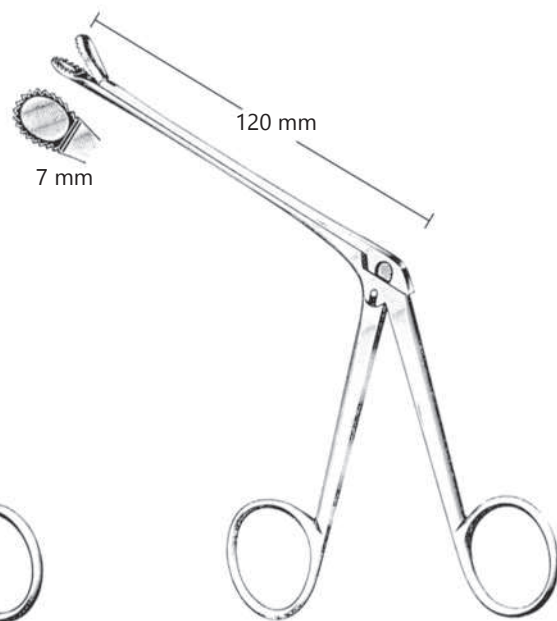

BLASKESLEY
 11-182-00

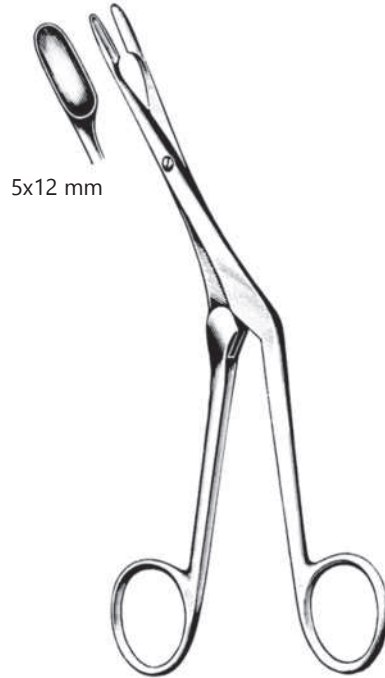

KNIGHT
11-184-19
19 cm

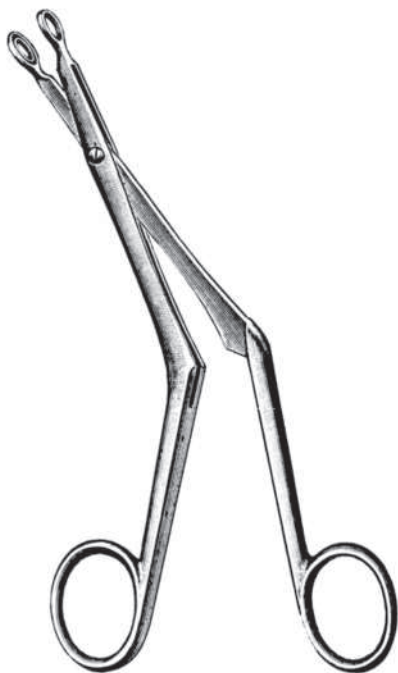

BRUENINGS
11-186-01 - 11-188-03
19 cm

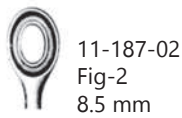

LUC-BRUENINGS
(Heymann)
11-190-01 - 11-191-02
18 cm

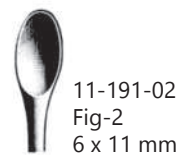
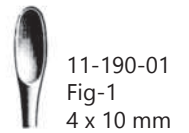

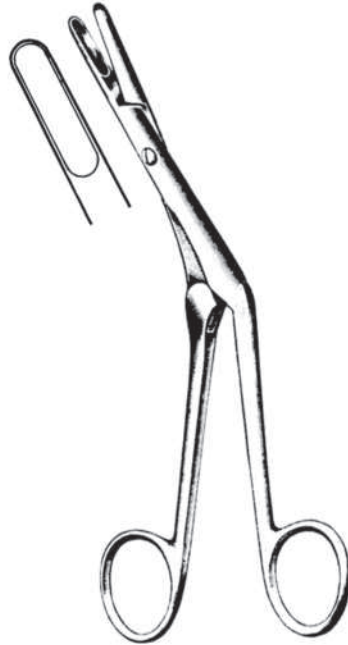

CRAIG
 11-193-17
 17 cm



CRAIG-DOMNICK
 11-195-17 - 11-196-17
 17 cm



11-195-17
 7 x 18 mm
 curved to right



11-196-17
 7 x 18 mm
 curved to left

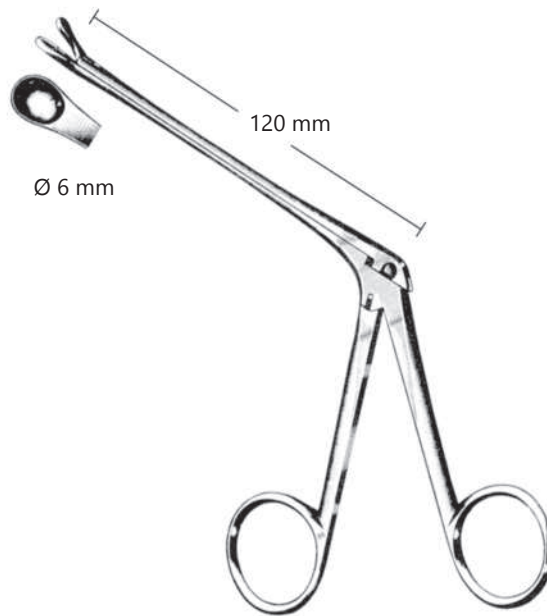

WATSON-WILLIAMS
 11-198-00

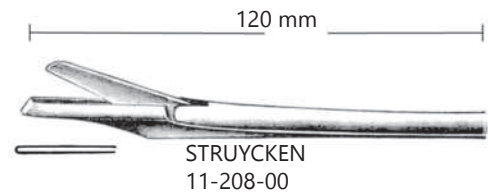

STRUYCKEN
 11-208-00

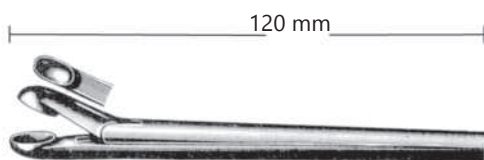

WATSON-WILLIAMS
 11-200-00
 3 x 6 mm, straight

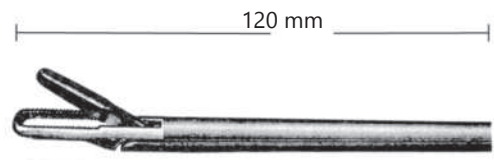

HENKE
 11-210-00
 3 x 11 cm

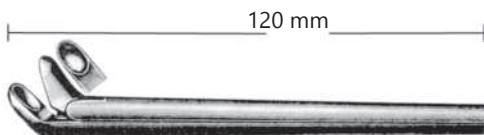

WATSON-WILLIAMS
 11-202-00
 3 x 5 mm, upward

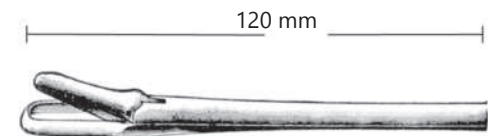

11-212-01 3 x 11 cm Fig-1
 11-213-02 3.5 x 14 cm Fig-2
 11-214-03 4 x 15 cm Fig-3

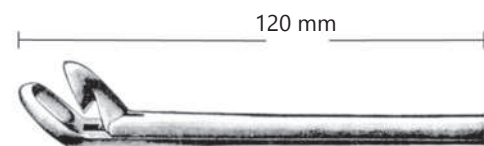

11-204-01 3.5 x 5 mm Fig-1
 11-205-02 4 x 6 mm Fig-2
 11-206-03 4.5 x 7 mm Fig-3

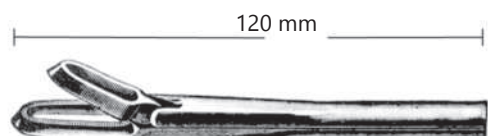

11-216-01 2 x 10 mm Fig-1
 11-217-02 2.5 x 12 mm Fig-2
 11-218-03 3 x 14 mm Fig-3
 11-219-04 3.7 x 15 mm Fig-4



COTTLE-WALSHAM
 11-221-01 - 11-223-03
 23 cm



11-221-01
 Fig-1



11-222-02
 Fig-2



11-223-03
 Fig-3



KAZANJIAN
 11-225-18
 18 cm



12

Mouth and Tongue
Mund und Zunge
Boca y lengua



MIDDELDORPF
12-010-21
12-012-22
12-014-23



12-010-21 21.5 cm
12-011-21 21.5 cm
14 x 17 mm



12-011-22 22 cm
12-013-22 22 cm
20 x 22 mm



12-014-23 23.5 cm
12-015-23 23.5 cm



MIDDELDORPF
12-011-21
12-013-22
12-015-23

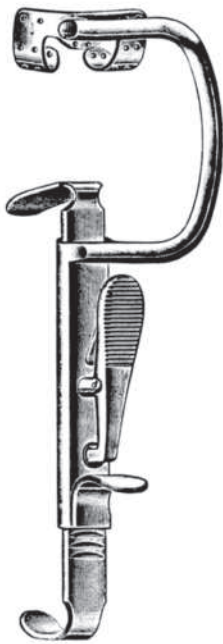

DAVIS - BOYLE
12-017-10
10 cm

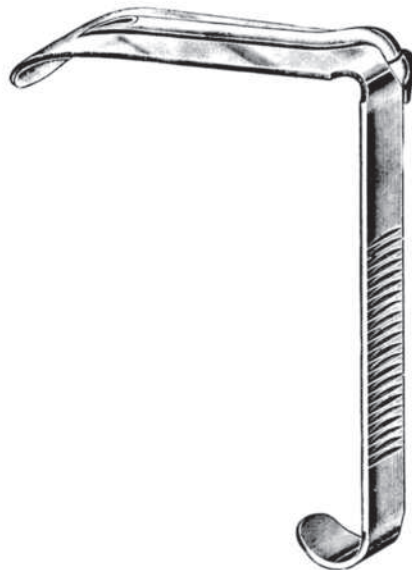

Fig-1
DAVIS - BOYLE
12-019-01
27 x 105 mm



Fig-2
12-020-02
25 x 90 mm



Fig-3
12-021-03
25 x 75 mm



Fig-4
12-022-04
25 x 60 mm



Fig-4
12-023-04
20 x 25 mm

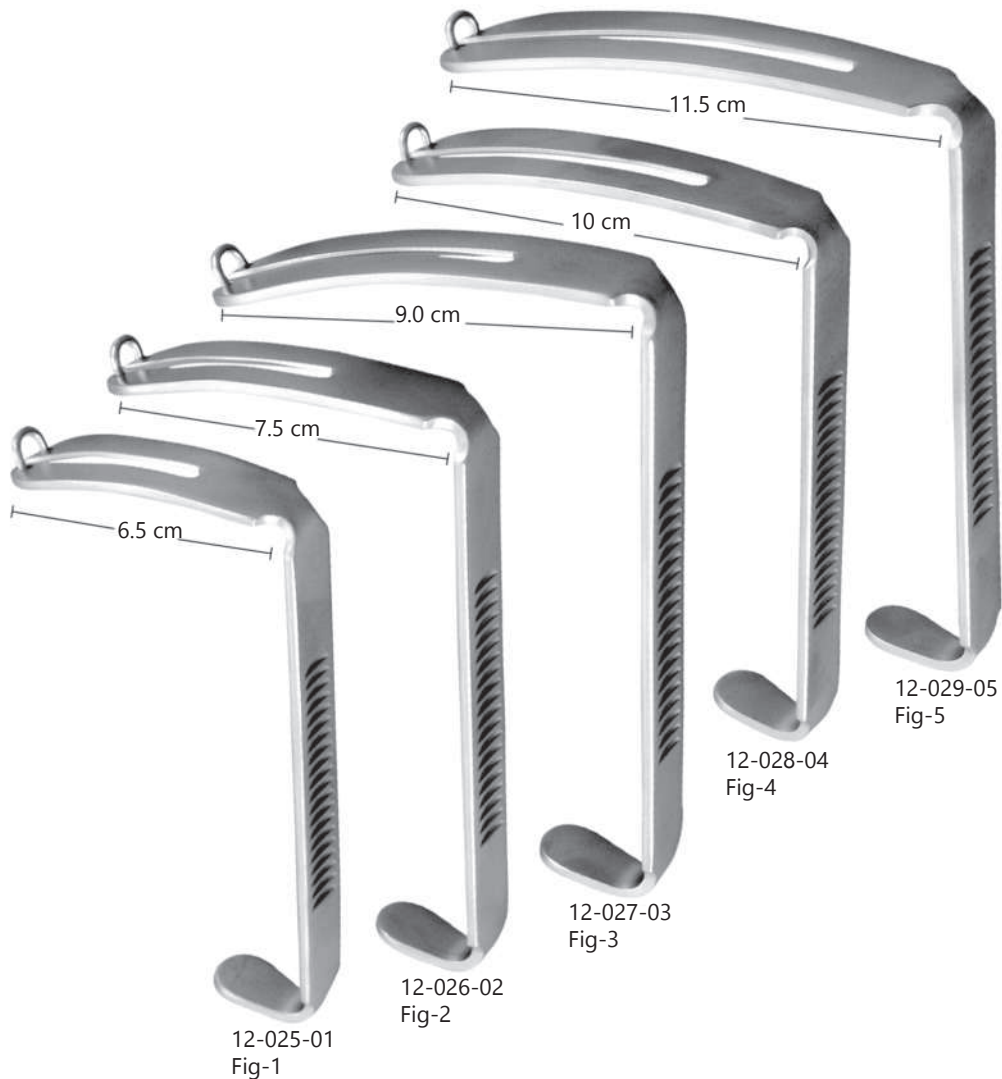

12-025-01
Fig-1

12-026-02
Fig-2

12-027-03
Fig-3

12-028-04
Fig-4

12-029-05
Fig-5



ROSER-KONG
12-035-16
16 cm



DENHART
12-031-12
12.5 cm

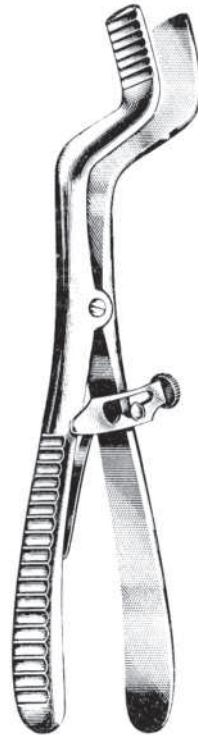

ROSER-KONG
12-033-18
18.5 cm



FERGUSSON-ACKLAND
12-037-15
14.5 cm

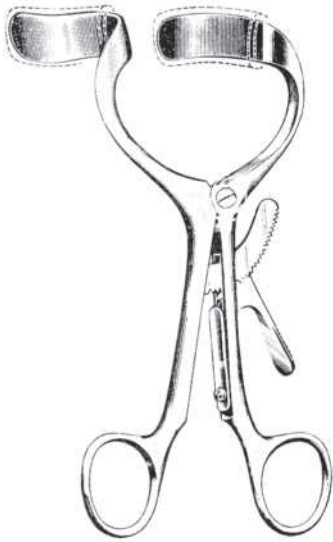

DOYEN-JANSEN
12-039-14
14 cm



DOYEN-COLLIN
12-041-12
12 cm

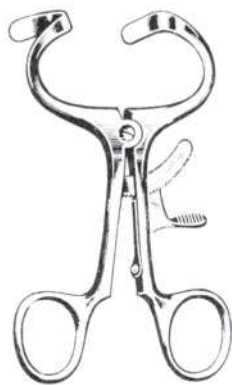

MOLT
12-043-10
10 cm



HEISTER
12-045-13
13 cm



WILLIGER
12-047-16
16.5 cm



WILLIGER
12-049-17
17.5 cm



WILLIGER
12-051-14
14 cm



WILLIGER
12-053-16
16 cm



SEWAL
12-055-20
20 cm

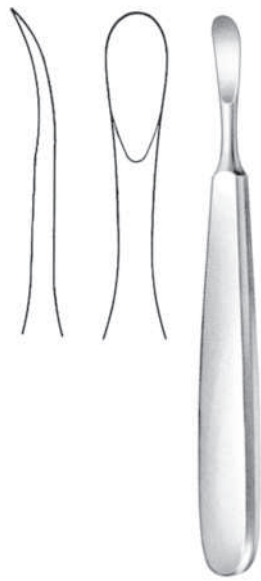

TRELAT
12-057-15
15 cm



12-059-18
18 cm

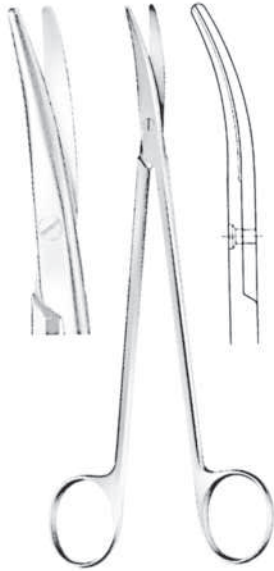

METZENBAUM
12-061-18
18 cm

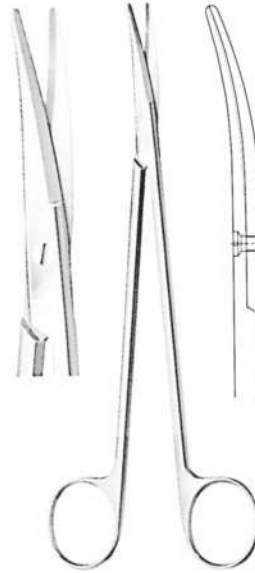

METZENBAUM
12-063-18
18 cm

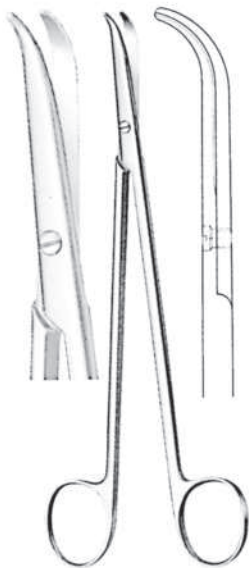

THOREK
12-065-18
18 cm



METZENBAUM
12-063-18
18 cm



DEAN
12-069-17
17 cm

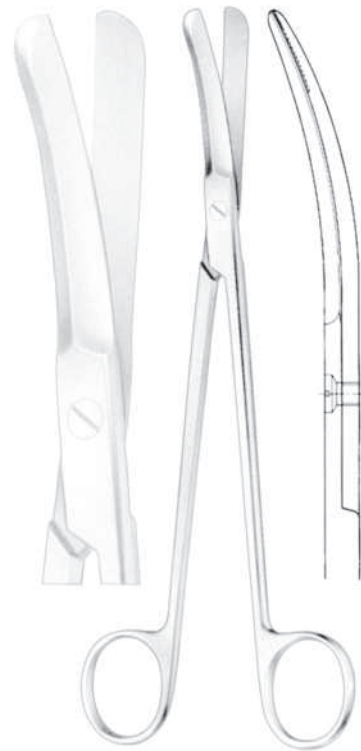

SCHWECKENDIEK
12-071-19
19.5 cm

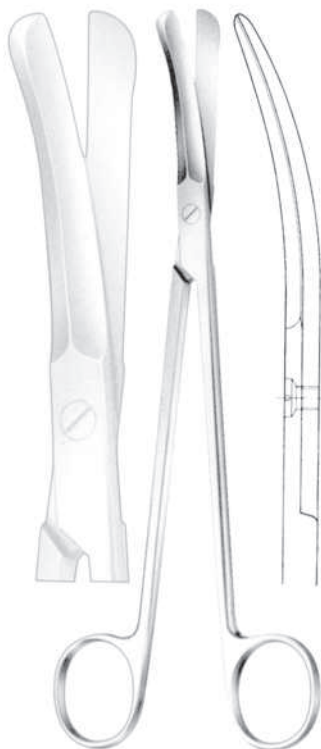

GOOD
12-073-19
19.5 cm

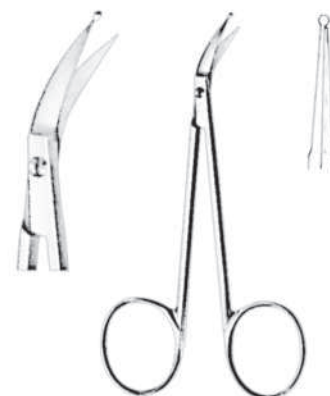

PERWITZSCHKY
12-075-10
10 cm

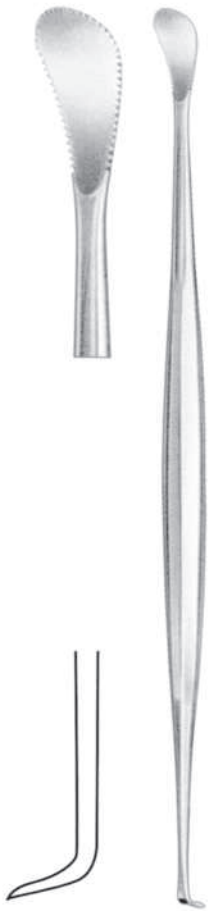

HENKE
 12-077-23
 23.5 cm



HENKE
 12-079-23
 23.5 cm



GWYNNE EVANS
 12-081-06 0.6 cm
 12-083-08 0.8 cm
 20 cm



LOPEZ-REINKE
 12-085-23
 23.5 cm



SYME
12-087-18
18.5 cm



MOLLINSON
12-089-21
21 cm

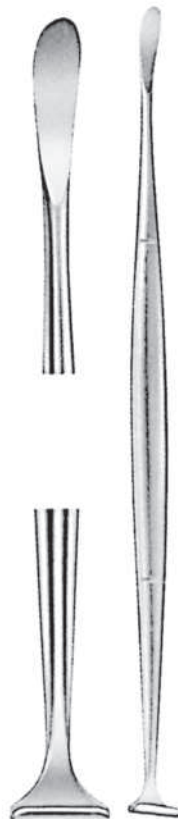

HURD
12-091-21
21.5 cm



HURD
12-093-21
21.5 cm



FISHER
12-095-20
20.5 cm



BRUNINGS
12-097-21
21.5 cm



ABRAHAM
12-099-21
21.5 cm



FOWLER
12-101-20
20 cm



WAUGH
12-103-20
20 cm



WAUGH
12-105-20
20 cm



MARSCHIK
12-107-22
22 cm



NEGUS
 12-109-19 - 12-110-19
 18 cm

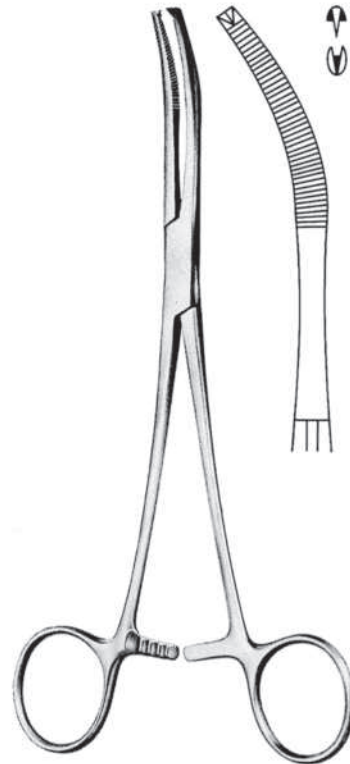

MIKULICZ
 12-112-20
 20 cm

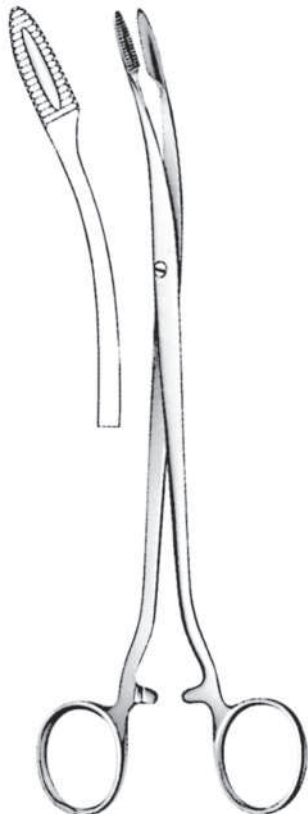

DUPLAY
 12-114-21
 21 cm

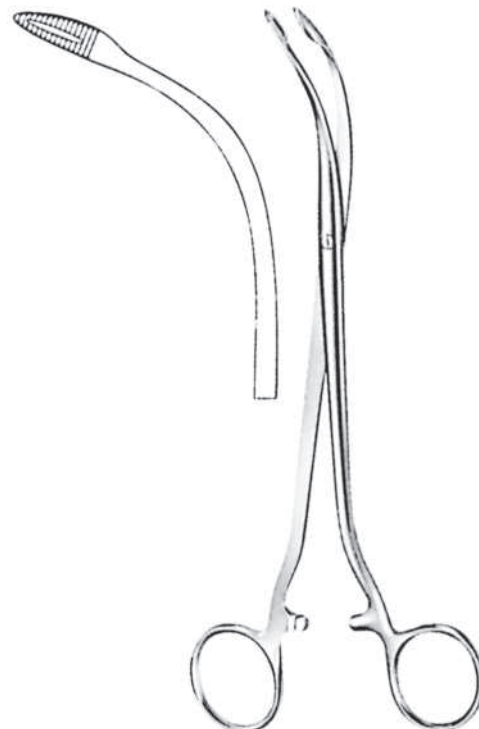

DUPLAY
 12-116-19
 19 cm



LUCAS
12-118-18
18 cm



LUCAS
12-120-18
18.5 cm



MILLER
12-122-18
18 cm



MOLT
12-124-18
18 cm



12-126-20

12-127-20

12-129-20

12-130-20

12-132-21

12-132-21

DESCHAMPS blunt
12-126-20 - 12-127-20
20 cm

DESCHAMPS sharp
12-129-20 - 12-130-20
20 cm

DESCHAMPS blunt
12-132-21 - 12-133-21
21 cm



OBWEGESER
12-135-23
23 cm



12-137-23
23 cm

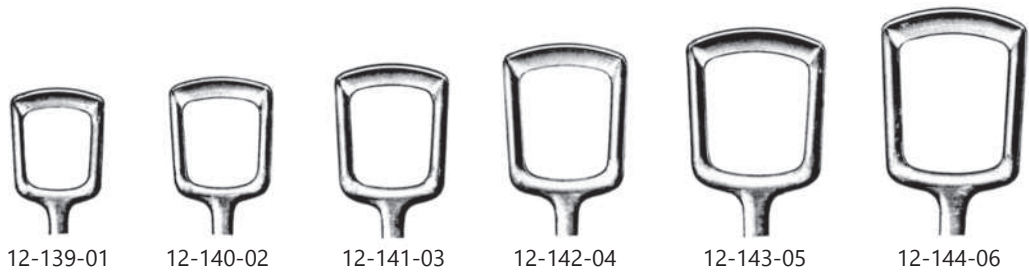

BECKMANN
12-139-01 - 12-144-06
20 cm

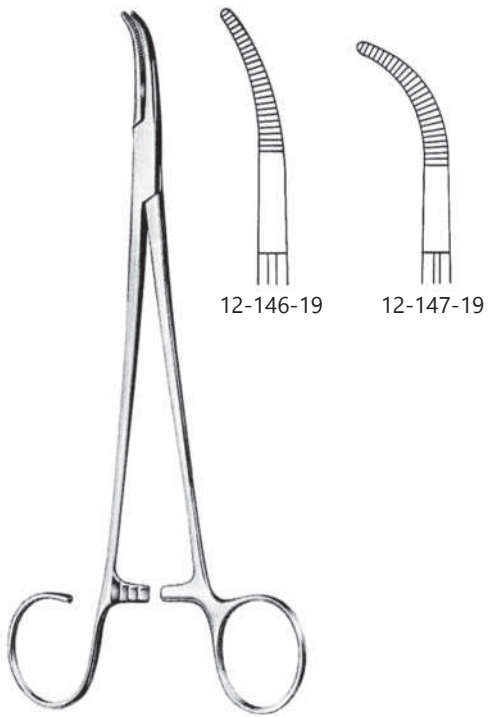

12-146-19

12-147-19

SCHNIDT-SAWTELL
 12-146-19 - 12-147-19
 19 cm

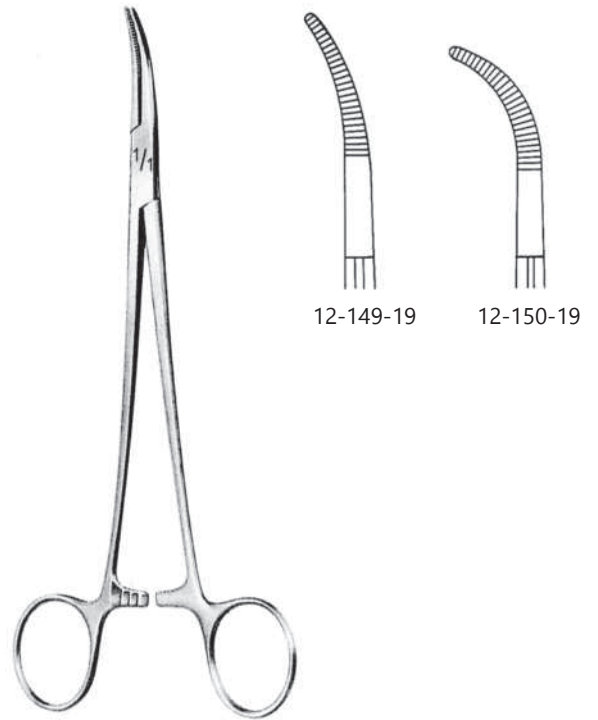

12-149-19

12-150-19

SCHNIDT-SAWTELL
 12-149-19 - 12-150-19
 19 cm

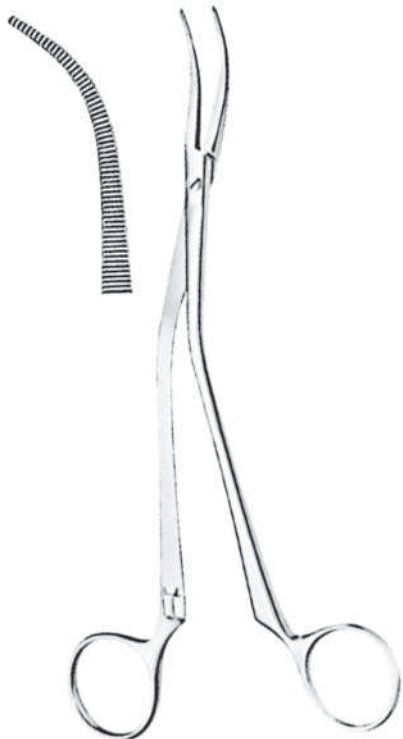

WILSON
 12-152-19
 19 cm

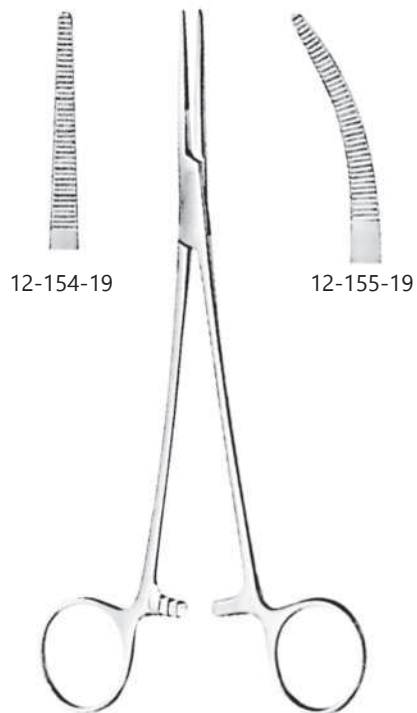

12-154-19

12-155-19

BIRKET
 12-154-19 - 12-155-19
 19 cm

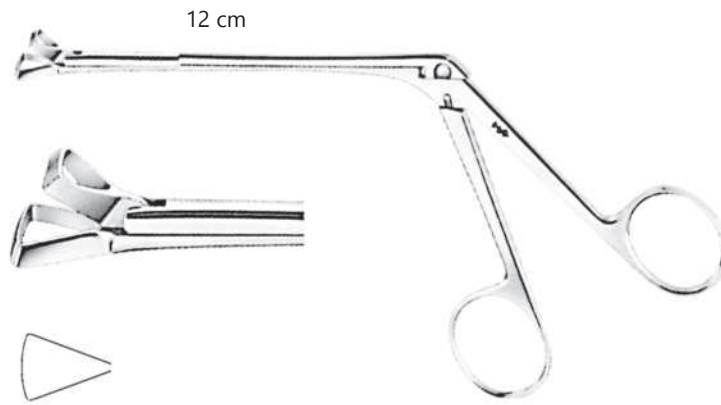

SCHMEDEN
12-157-12

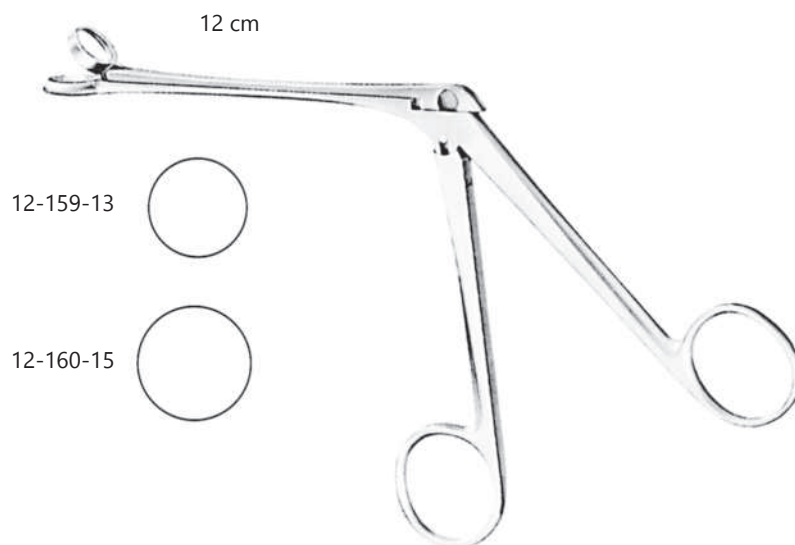

HARTMAN
12-159-13 1.3 cm
12-160-15 1.5 cm



MUSEUX
12-162-20
20 cm



COLVER
12-164-20
20 cm



WHITE
12-166-18
18 cm



WHITE
12-168-23
23.5 cm



BLOHMKE
12-170-20
20.5 cm



ABRAHAM
12-172-20
20.5 cm



MARSCHIK-KRONE
12-174-20
20.5 cm

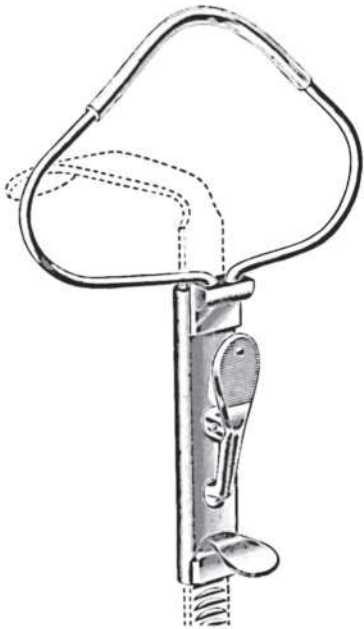

McLVOR
12-176-10
10 cm

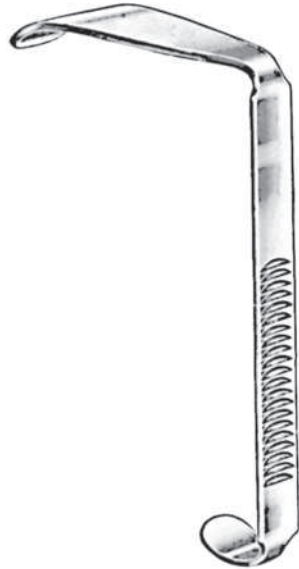

12-178-01
27 x 95 mm

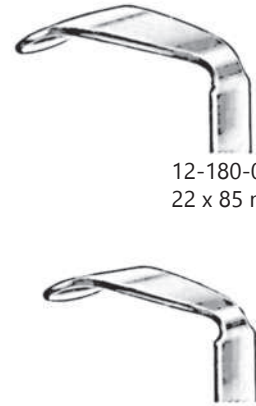

12-180-02
22 x 85 mm

12-182-03
22 x 70 mm



JENNINGS
12-184-09 9 cm
12-185-11 11 cm
12-186-13 13 cm
12-187-15 15 cm



STEMBERG
12-189-12 12 cm
12-190-14 14 cm
12-191-16 16 cm



STEMBERG
12-193-14 14 cm
12-194-16 16 cm
12-195-16 18 cm



COLLIN
12-197-16
16 cm



YOUNG
12-199-17
17 cm



BRUENINGS
12-201-19
19 cm



BRUENINGS
12-203-19
19 cm



MAYO
12-205-17
17 cm



12-207-01
Fig-1
14 cm



12-208-02
Fig-2
15 cm



WIEDER
12-207-01 - 12-208-02



TOBOLD
12-210-01
1.5 cm



PLESTER-R
12-212-10 10 cm blunt
12-213-13 13 cm blunt



PLESTER-L
12-215-10 10 cm blunt
12-216-13 13 cm blunt

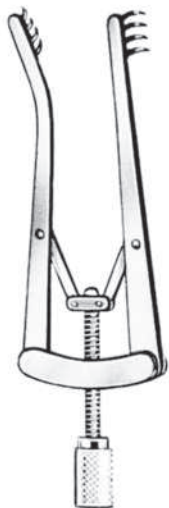

ALM
12-218-07 7.0 cm sharp
12-219-07 7.0 cm blunt
12-220-10 10 cm sharp
12-221-10 10 cm blunt



FINSEN
12-223-05 5.0 cm sharp
12-224-05 5.0 cm blunt
12-225-05 7.0 cm sharp
12-226-07 7.0 cm blunt



ALLPORT
12-228-09
9.5 cm
sharp



- | | | |
|-----------|------------------|-----------|
| 12-230-08 | Fig-00 = 8 mm Ø | 12-243-08 |
| 12-231-10 | Fig-0 = 10 mm Ø | 12-244-10 |
| 12-232-12 | Fig-1 = 12 mm Ø | 12-245-12 |
| 12-233-14 | Fig-2 = 14 mm Ø | 12-246-14 |
| 12-234-16 | Fig-3 = 16 mm Ø | 12-247-16 |
| 12-235-18 | Fig-4 = 18 mm Ø | 12-248-18 |
| 12-236-20 | Fig-5 = 20 mm Ø | 12-249-20 |
| 12-237-22 | Fig-6 = 22 mm Ø | 12-250-22 |
| 12-238-24 | Fig-7 = 24 mm Ø | 12-251-24 |
| 12-239-26 | Fig-8 = 26 mm Ø | 12-252-26 |
| 12-240-28 | Fig-9 = 28 mm Ø | 12-253-28 |
| 12-241-30 | Fig-10 = 30 mm Ø | 12-254-30 |



YOUNG
12-256-10
10 cm



FARRELL
(Lathbury-Uebe)

- 12-258-12 12 cm
- 12-259-14 14 cm
- 12-260-16 16.5 cm



Fig	mm Ø	45 - 90 mm	Medium 95 mm
0	4	12-262-04	
1	5	12-263-05	
2	6	12-264-06	
3	7	12-265-07	
4	8	12-266-08	12-272-08
5	9	12-267-09	12-273-09
6	10	12-268-10	12-274-10
7	11	12-269-11	12-275-11
8	12	12-270-12	12-276-12
9	13	12-271-13	12-277-13

Fig	mm Ø	45 - 90 mm
0	4	12-279-04
1	5	12-280-05
2	6	12-281-06
3	7	12-282-07
4	8	12-283-08
5	9	12-284-09
6	10	12-285-10
7	11	12-286-11
8	12	12-287-12
9	13	12-288-13



LABORDE
12-290-14
14 cm



TROUSSEAU
12-292-14
14 cm



KRAUSE
12-294-16
16 cm



KRAUSE VOSS
12-296-16
16 cm



EVES
Tonsil Snare
12-298-25
25 cm



EVES
Tonsil Snare
12-300-25
25 cm



13

Gynecology
Gynäkologie
Ginecología



KALLMORGEN
 13-010-01 70 x 40 mm
 13-011-02 90 x 40 mm



AUVARD
 13-013-24 105 x 38 mm
 24 cm



VAGINAL RETRACTOR
 13-015-01 70 x 33 mm
 13-016-02 90 x 33 mm



MATHIEU
 13-018-01 95 x 16 mm
 95 x 26 mm
 13-019-02 95 x 16 mm
 95 x 30 mm



13-021-01 100 x 11 mm
 100 x 20 mm
 13-022-02 100 x 14 mm
 100 x 26 mm



SIMS
13-024-01 65 x 25 mm
70 x 30 mm
13-025-01 70 x 30 mm
70 x 35 mm
13-026-03 85 x 35 mm
90 x 40 mm



KRISTELLER
Specula
13-028-01 Fig-1 = 70 x 27 mm
13-029-02 Fig-2 = 80 x 30 mm
13-030-03 Fig-3 = 90 x 36 mm



KRISTELLER
retractors
13-032-01 Fig-1 = 75 x 23 mm
13-033-02 Fig-2 = 85 x 26 mm
13-034-03 Fig-3 = 100 x 32 mm



KRISTELLER
set of 1 speculam and 1 retractor each
13-032-01 Fig-1 = 75 x 23 mm
13-033-02 Fig-2 = 85 x 26 mm
13-034-03 Fig-3 = 100 x 32 mm



KEISTELLER
specula
13-040-01 Fig-1 = 105 x 18 mm
13-041-02 Fig-2 = 105 x 21 mm



KEISTELLER
retractors
13-043-01 Fig-1 = 110 x 14 mm
13-044-02 Fig-2 = 110 x 17 mm



KEISTELLER
set of 1 speculum and 1 retractor each
13-046-01 Fig-1
13-047-02 Fig-2



KRISTEKKER
 specula
 13-049-01 Fig-1 = 105 x 26 mm
 13-050-01 Fig-2 = 105 x 28 mm
 13-051-03 Fig-3 = 105 x 33 mm



KRISTEKKER
 retractors
 13-053-01 Fig-1 = 115 x 22 mm
 13-054-02 Fig-2 = 115 x 24 mm
 13-055-03 Fig-3 = 115 x 29 mm



KRISTELLER
 set of 1 Specula and 1 Retractor each
 13-057-01 Fig-1
 13-058-02 Fig-2
 13-059-03 Fig-3



KRISTEKKER
 specula
 13-061-01 Fig-1 = 110 x 27 mm
 13-062-02 Fig-2 = 110 x 30 mm
 13-063-03 Fig-3 = 110 x 36 mm



KRISTEKKER
 retractors
 13-065-01 Fig-1 = 115 x 23 mm
 13-066-02 Fig-2 = 115 x 26 mm
 13-067-03 Fig-3 = 115 x 32 mm



KRISTEKKER
 set of 1 specula and 1 retractors
 13-069-01 Fig-1
 13-070-02 Fig-2
 13-071-03 Fig-3



OEDERSON
13-073-01 75 x 13 mm
13-074-02 100 x 22 mm
13-075-03 120 x 25 mm



SEMM
13-077-01 65 x 20 mm
13-078-02 90 x 16 mm



COLLIN
13-080-01 85 x 30 mm
13-081-02 100 x 35 mm
13-082-03 110 x 40 mm

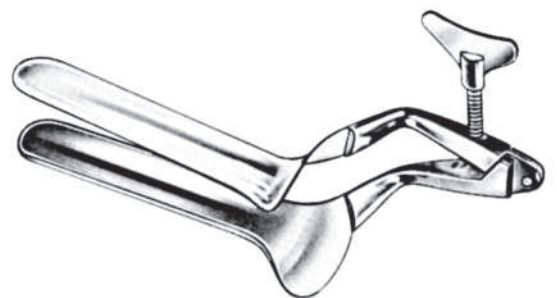

COLLIN
13-084-01 100 x 17/20 mm
13-085-02 100 x 25/30 mm



GRAVE
13-087-01 75 x 20 mm
13-088-02 95 x 35 mm
13-089-03 115 x 35 mm



CUSCO
13-091-01 75 x 17 mm



CUSCO
13-093-01 75 x 32 mm
13-094-02 85 x 35 mm
13-095-03 100 x 37 mm



CUSCO
13-097-01
75 x 17 mm



CUSCO
13-099-01 75 x 32 mm
13-100-02 85 x 35 mm
13-101-03 100 x 35 mm



CUSCO
13-103-01 80 x 22 mm
13-104-02 100 x 25 mm
13-105-03 105 x 27 mm



FANO
 EXTRA SMALL (VIRGO)
 13-107-01
 13 x 80 mm

FANO
 MEDIUM
 13-109-02
 27 x 90 mm

FANO
 LARGE
 13-111-03
 30 x 110 mm

FANO
 EXTRA LARGE
 13-113-04
 30 x 130 mm



GENTOFTE
EXTRA SMALL (VIRGO)
13-115-01
15 x 80 mm



GENTOFTE
SMALL
13-117-02
27 x 105 mm



GENTOFTE
MEDIUM
13-119-03
30 x 110 mm



GENTOFTE
LARGE
13-121-04
32 x 120 mm



GENTOFTE
EXTRA LARGE
13-123-05
32 x 140 mm



BREISKY
13-125-01 16 x 20 mm
13-126-02 24 x 28 mm
13-127-03 32 x 36 mm
13-128-04 40 x 44 mm



BRAUN
13-130-15 15 mm 25 cm 10"
13-131-25 25 mm 25 cm 10"



DOYEN
 13-133-24
 24 cm

- DOYEN
- 13-135-01 55 x 35 mm
 - 13-134-02 58 x 35 mm
 - 13-135-03 115 x 35 mm
 - 13-136-01 55 x 45 mm
 - 13-137-02 85 x 45 mm
 - 13-138-03 115 x 45 mm
 - 13-139-04 160 x 45 mm
 - 13-140-01 55 x 60 mm
 - 13-141-02 85 x 60 mm
 - 13-142-03 115 x 60 mm
 - 13-143-04 160 x 60 mm

- BREISKY
- 13-145-01 100 x 20 mm
 - 13-146-02 100 x 25 mm
 - 13-147-03 100 x 30 mm
 - 13-148-04 100 x 35 mm
 - 13-149-05 100 x 40 mm
 - 13-150-01 130 x 20 mm
 - 13-151-02 130 x 25 mm
 - 13-152-03 130 x 30 mm
 - 13-153-04 130 x 35 mm
 - 13-154-05 130 x 40 mm
 - 13-155-05 155 x 40 mm

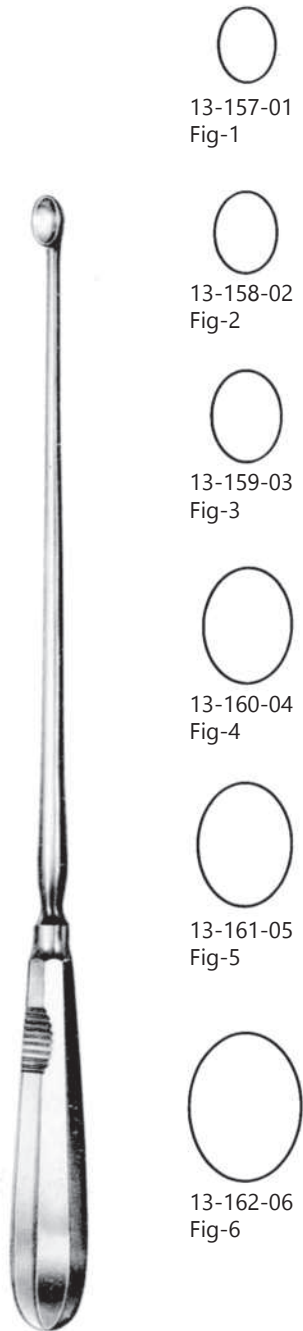

SCHROEDER
13-157-01 - 13-162-06
30 cm
sharp

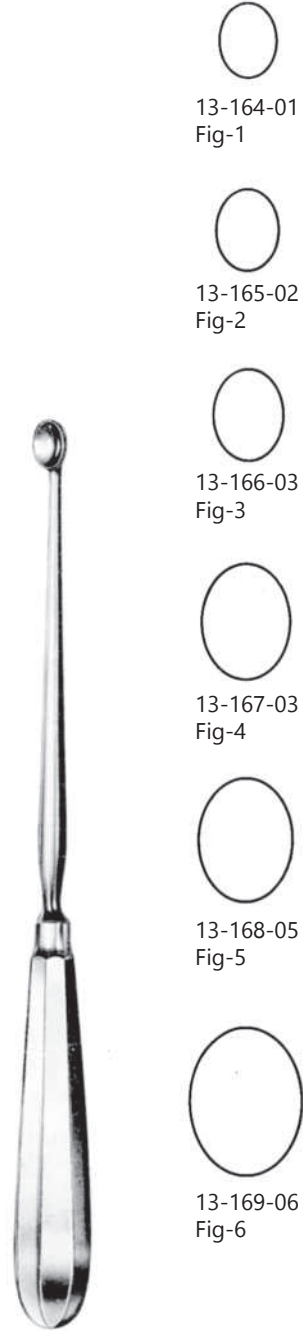

SIMON
13-164-01 - 13-169-06
25 cm
sharp

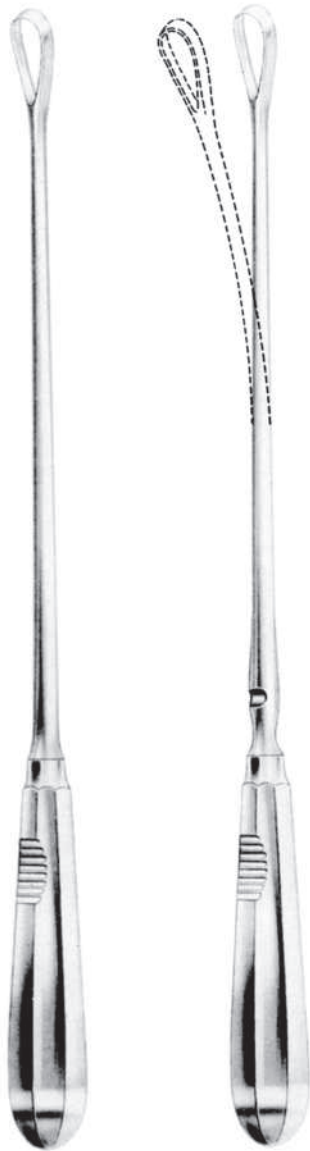

RECAMIER - SIMS - BUMM	
Rigid	Malleable
13-171-31	13-172-31
31 cm	31 cm



RECAMIER - SIMS - BUMM	
Rigid	Malleable
13-174-31	13-175-31
31 cm	31 cm

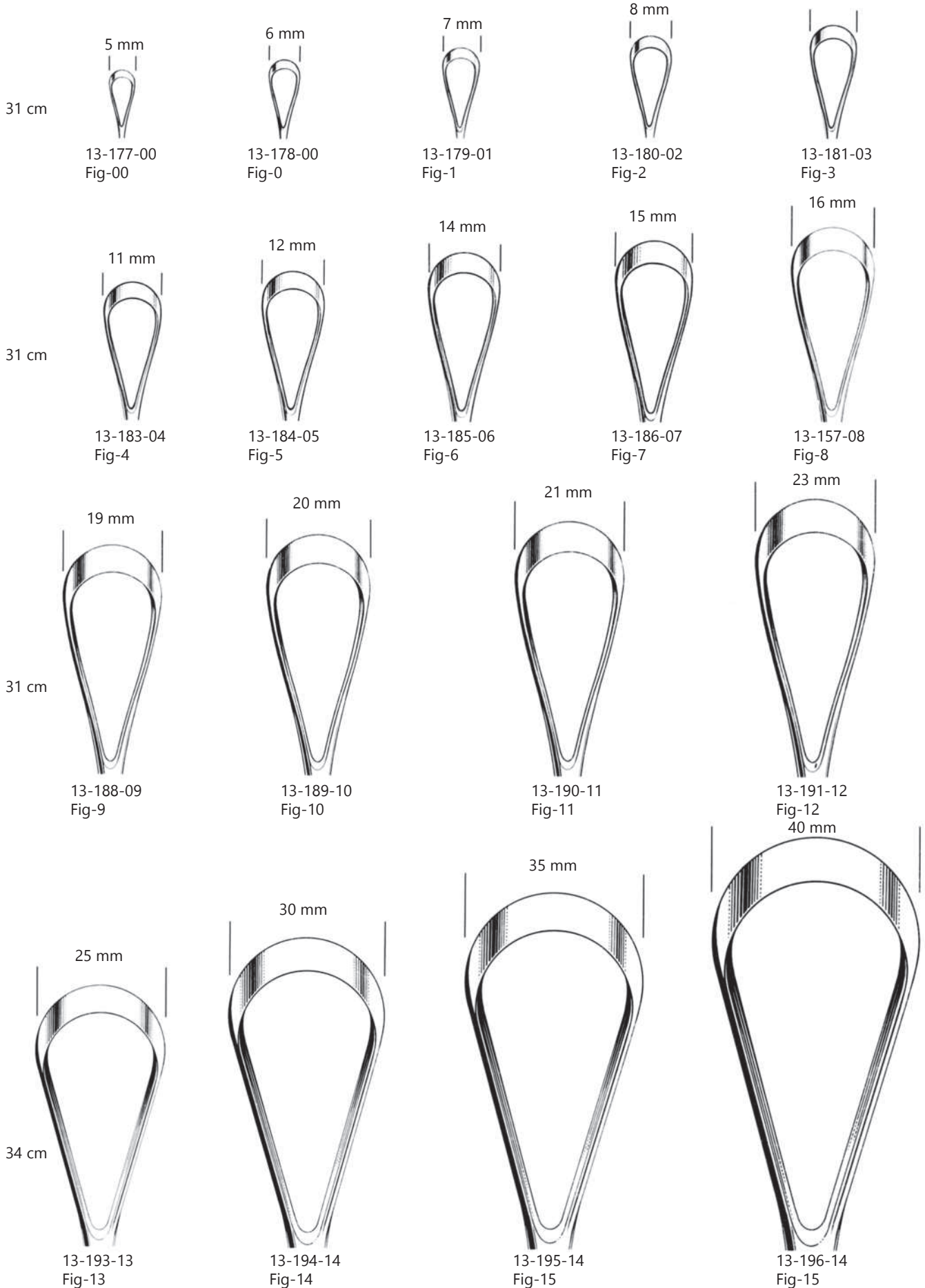

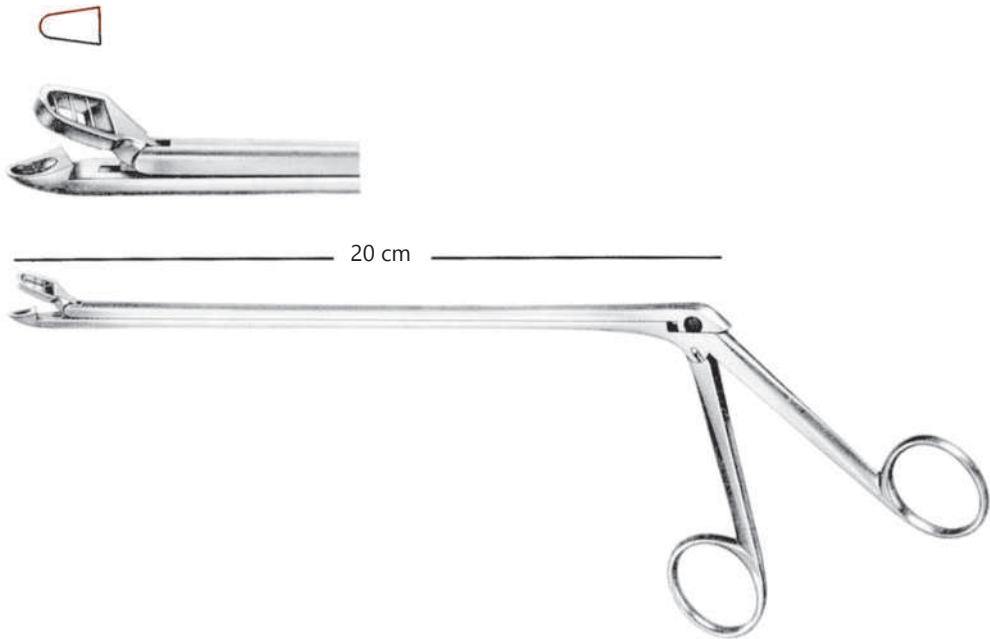

ALEXANDER
13-198-28
28 cm

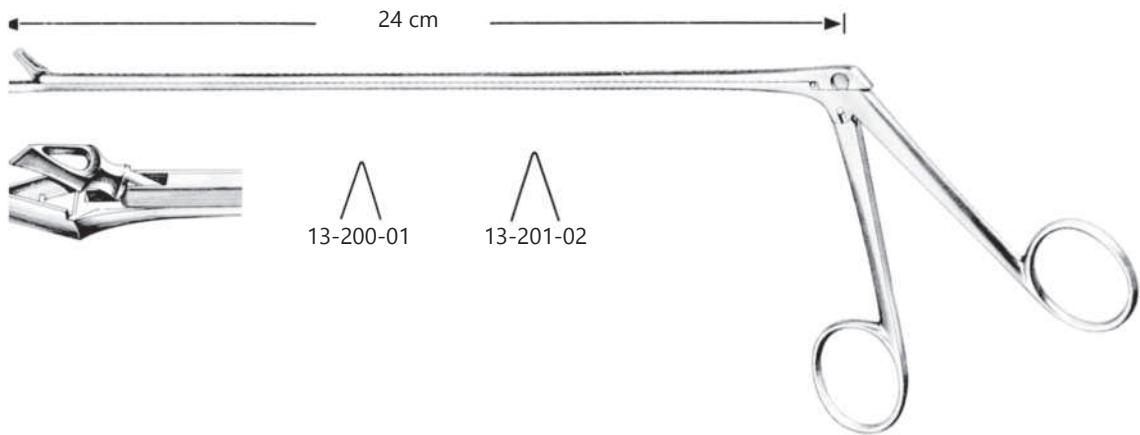

SCHUMACHER
13-200-01 - 13-201-02

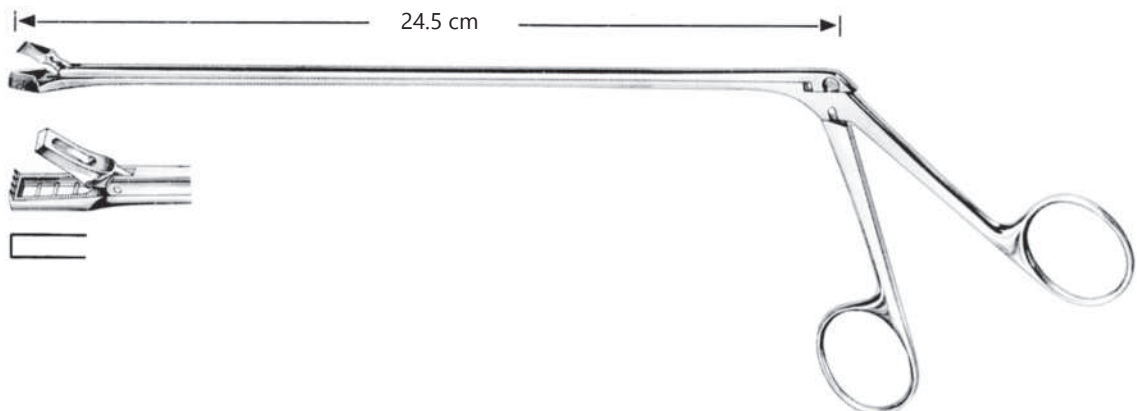

KEVORKIAN
13-203-32



VAN DOREN
13-205-24
24 cm

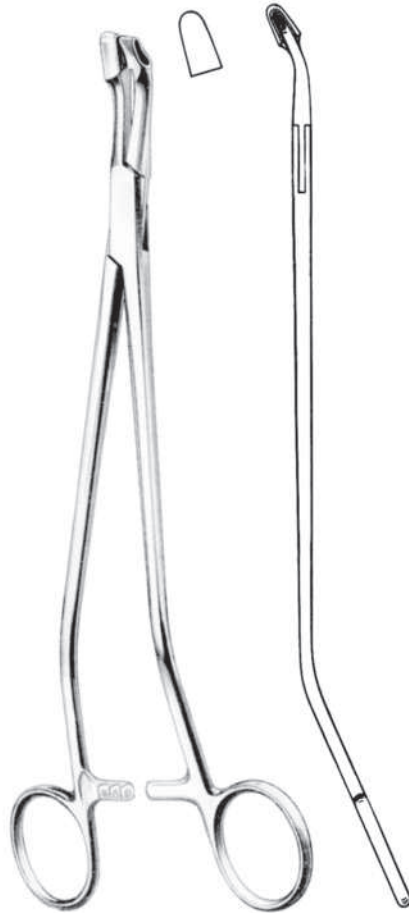

VAN DOREN
13-207-25
25 cm



FAURE
13-209-21
21 cm



THOMS-GAYLOR
 13-211-22 22 cm
 13-212-24 24 cm



THOMS-GAYLOR
 13-214-24
 24 cm



GELLHORN
 13-216-23
 23 cm



SCHUBERT
13-218-21 22 cm
13-219-29 29 cm



SCHUBERT
13-221-26
26 cm



BEACHAM
 13-223-26
 26 cm

LOWA
 13-225-26
 26 cm

SKENE
 13-227-24
 24 cm

STAUDE-MOORE
 13-229-17
 17 cm



BRAUN
13-231-25
25 cm



DUPLAY
13-233-28
28 cm



SCHROEDER
 13-235-25
 25 cm

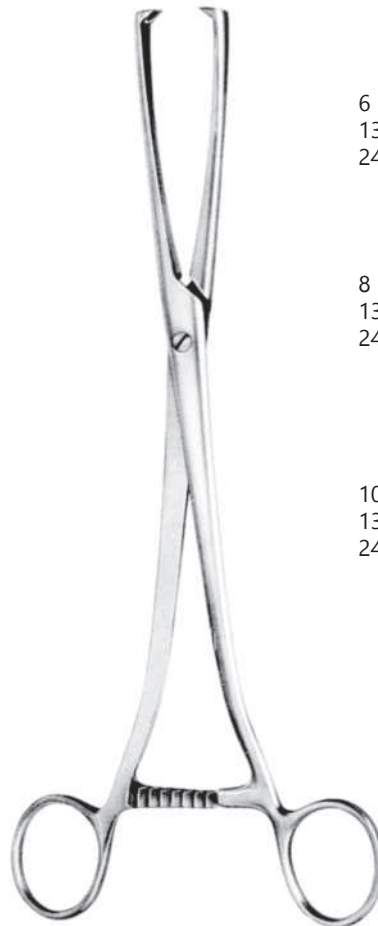

MUSEUX
 13-237-24 - 13-239-24
 24 cm



TEALE
 13-241-23
 23 cm



POZZI
13-243-25
25 cm



SCHROEDER
13-245-24 - 13-246-24
24 cm

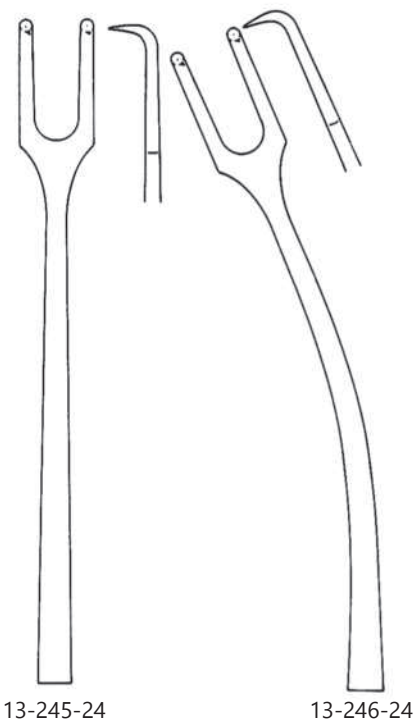

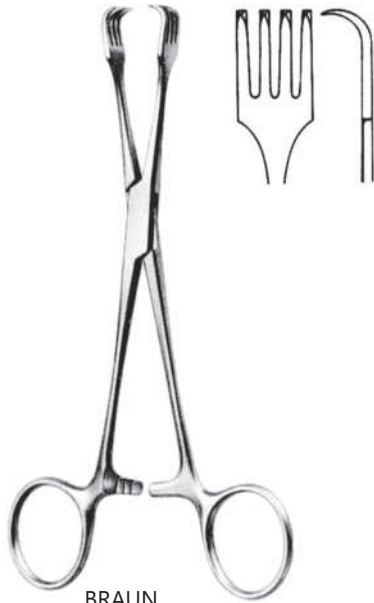

BRAUN
 13-248-16
 15.5 cm



CZERNY
 13-250-20
 20 cm



13-252-26
 26 cm



JACOBS
 13-254-21
 21 cm

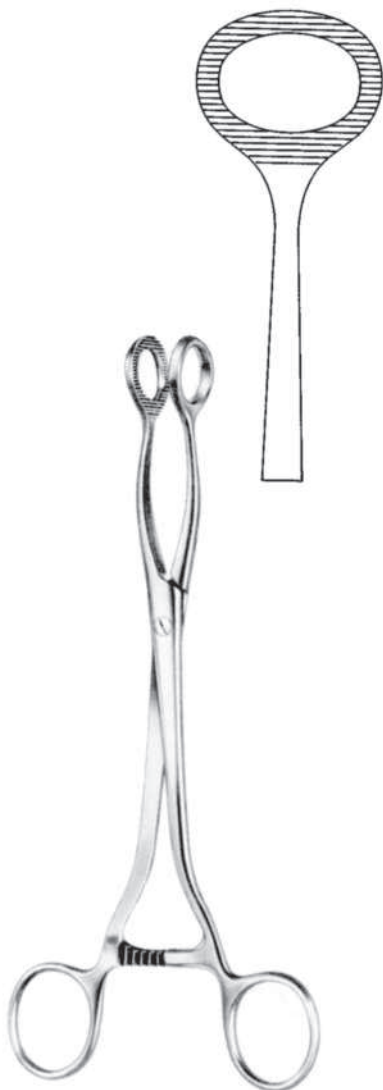

DOYEN
13-256-20
20 cm

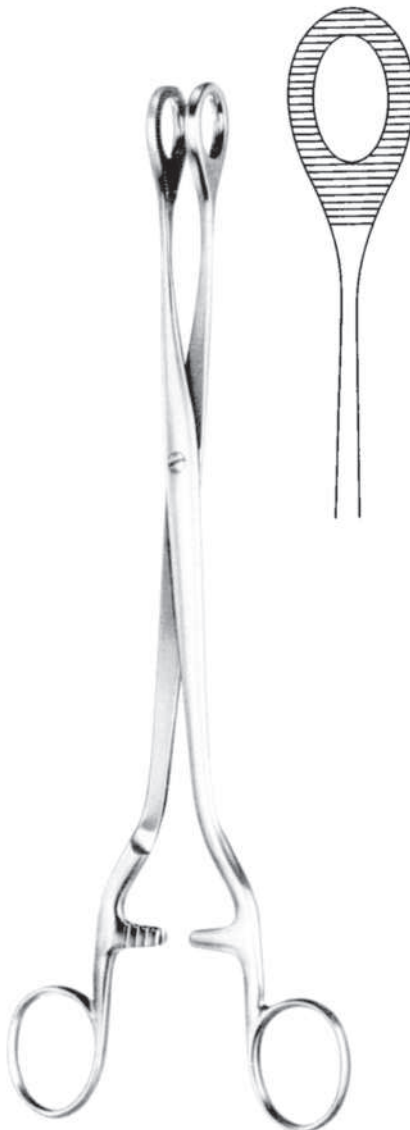

NOTO
13-258-27
27 cm



KELLY
13-260-32
32 cm



KOGAN
13-262-24
24 cm
without ratchet



KOGAN
13-264-24
24 cm
with scale-ratchet and fixing screws



KEVORKIAN
 13-266-30
 30 cm

NOVAK
 13-268-23
 23 cm

MOD-MUENCHEN
 13-270-27
 27 cm

Fistula Hooks, Cone Knife

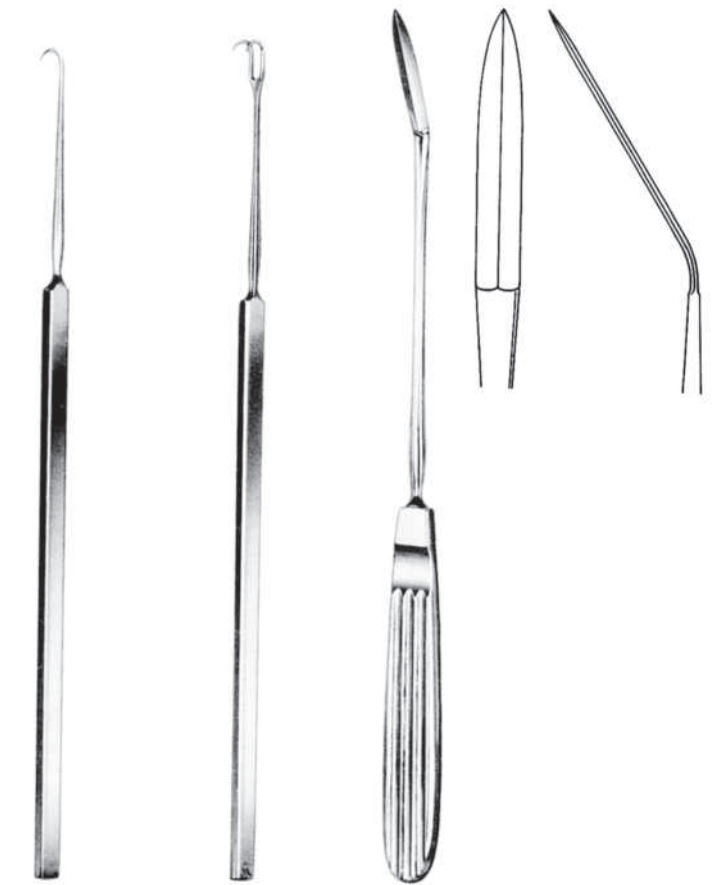

SIMON
 13-272-22
 22 cm

SIMON
 13-274-22
 22 cm

AYRE
 13-276-23
 23 cm



SIMS
13-278-32
32 cm



MARTIN
13-280-32
32 cm



VALLEIX
13-282-25
25 cm



BRAUN
13-284-28
28 cm



HANK
13-286-00
set 6 of pieces in canvas roll



fig 9/10 13-288-10 = 4.5/5 mm
fig 11/12 13-289-12 = 5.5/6 mm
fig 13/14 13-290-14 = 6.5/7 mm
fig 15/16 13-291-16 = 7.5/8 mm
fig 17/18 13-292-18 = 8.5/9 mm
fig 19/20 13-293-20 = 9.5/10 mm



HEGAR

Ø mm

1.0	13-295-01	18.5	13-330-18
1.5	13-296-01	19.0	13-331-19
2.0	13-297-02	19.5	13-332-19
2.5	13-398-02	20.0	13-333-20
3.0	13-299-03	21.0	13-334-21
3.5	13-300-03	22.0	13-335-22
4.0	13-301-04	23.0	13-336-23
4.5	13-302-04	24.0	13-337-24
5.0	13-303-05	25.0	13-338-25
5.5	13-304-05	26.0	13-339-26
6.0	13-305-07		
6.5	13-306-06		
7.0	13-307-07		
7.5	13-308-07		
8.0	13-309-08		
8.5	13-310-08		
9.0	13-311-09		
9.5	13-312-09		
10.0	13-313-10		
10.5	13-314-10		
11.0	13-315-11		
11.5	13-316-11		
12.0	13-317-12		
12.5	13-318-12		
13.0	13-319-13		
13.5	13-320-13		
14.0	13-321-14		
14.5	13-322-14		
15.0	13-323-15		
15.5	13-324-15		
16.0	13-325-16		
16.5	13-326-16		
17.0	13-327-17		
17.5	13-328-17		
18.0	13-329-18		

Ømm

1.0/2.0	13-340-02
3.0/4.0	13-341-04
5.0/6.0	13-342-06
7.0/8.0	13-343-08
9.0/10.0	13-344-10
11.0/12.0	13-345-12
13.0/14.0	13-346-14
15.0/16.0	13-347-16
17.0/18.0	13-348-18
19.0/20.0	13-349-20
21.0/22.0	13-350-22
23.0/24.0	13-351-24
25.0/26.0	13-352-26



52-1040-00 Set of 8 dilators 3.0/4.0 - 17.0/18.0 mm Ø



14

Obstetrics
Geburtshilfe
Obstetricia



SIMPSON
14-010-30
30 cm

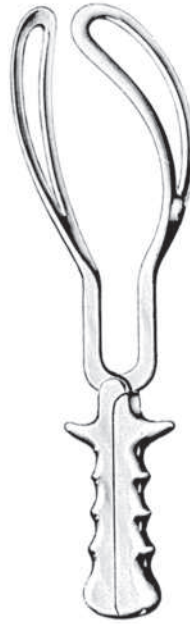

SIMPSON-BRAUN
14-012-36
36 cm



NAEGELE
14-014-36 36 cm
14-015-40 40 cm



MARTIN
14-017-34
34 cm



KELLAND
14-019-41
41 cm



De Lee
14-021-30
30 cm

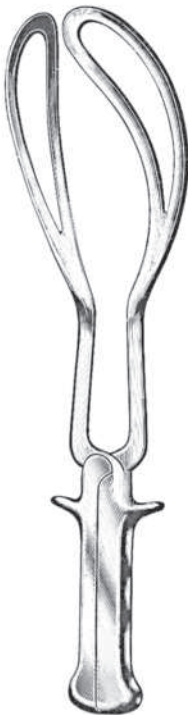

De Lee
14-023-36 36 cm
14-024-39 39 cm

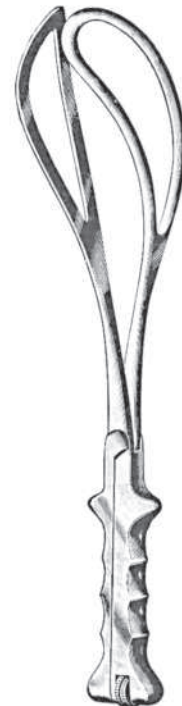

ELLIOT
14-026-32 32 cm
14-027-38 38 cm



Mc LEAN
14-029-36
36 cm



KIELLAND-LUIKART
14-031-36
40 cm

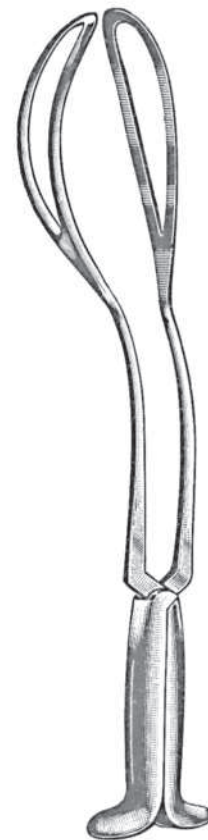

PIPER
14-033-36
44 cm

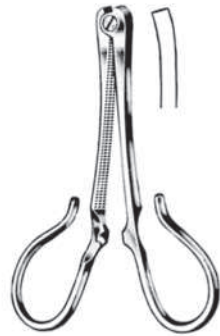

KANE
 14-035-08
 8.5 cm



COLLIN
 14-037-09
 9 cm

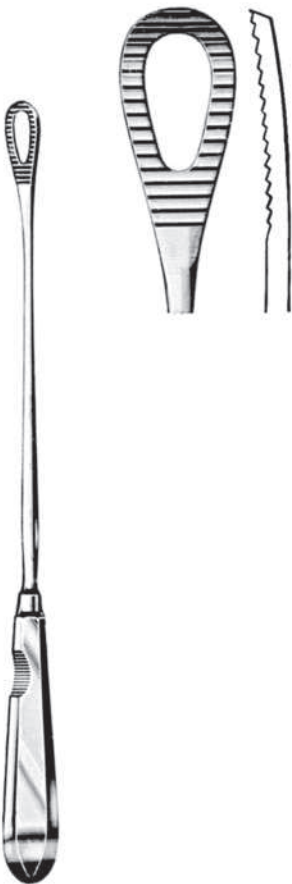

PESTALOZZA
 14-039-30
 30 cm

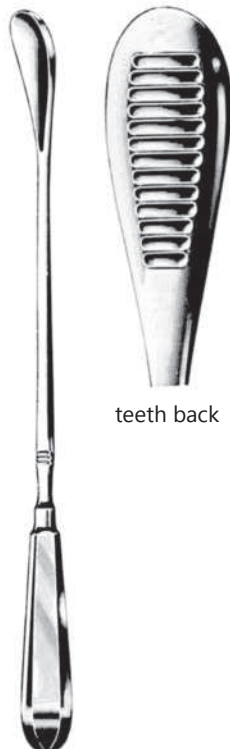
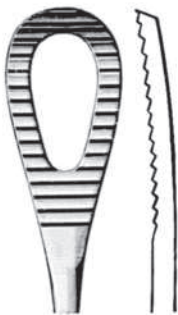

teeth back

CUZZI
 14-041-30 - 14-043-30
 30 cm



14-041-30



14-042-30



14-043-30

blunt



GREEN-ARMYTAGE
14-045-21
21 cm

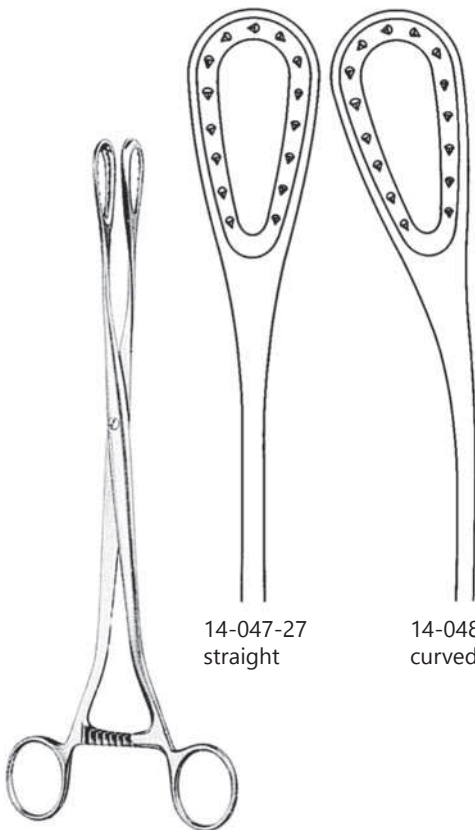

14-047-27
straight

14-048-27
curved

SAENGER
14-047-27 - 14-048-27
27 cm

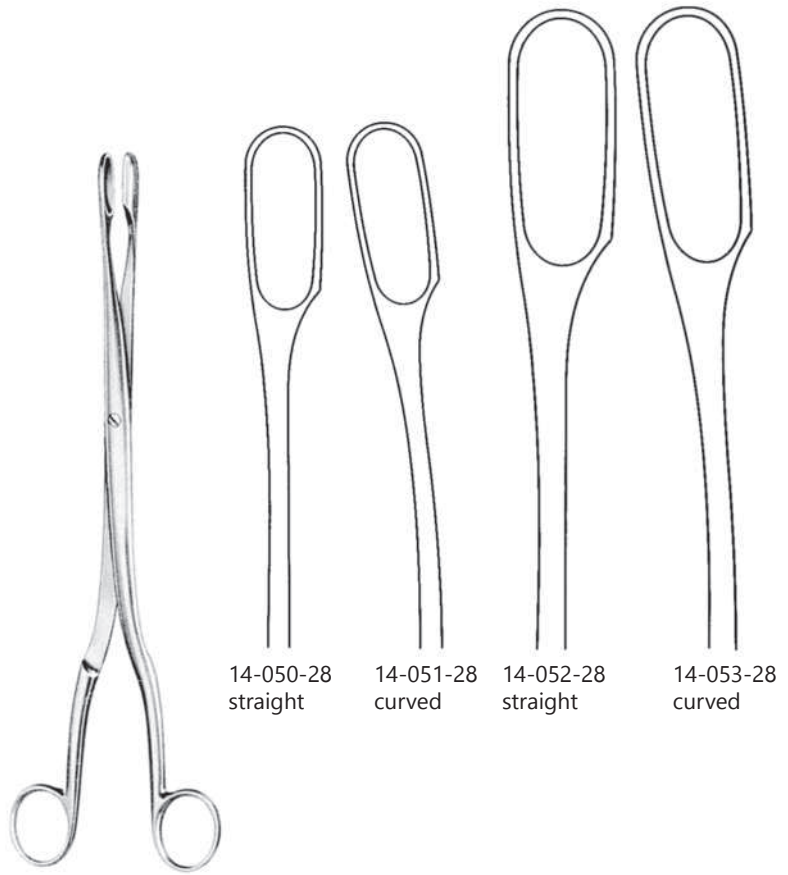

14-050-28
straight

14-051-28
curved

14-052-28
straight

14-053-28
curved

WINTER
14-050-28 - 14-053-28
28 cm



15

Probes
Sonden
Sondas



15-010-13 13 cm
15-011-14 14.5 cm
15-012-16 16 cm



15-014-13 13 cm
15-015-14 14.5 cm
15-016-16 16 cm



15-018-11 11.5 cm
15-019-13 13 cm
15-020-14 14.5 cm
15-021-16 16 cm
15-022-18 18 cm
15-023-20 20 cm
2 mm Ø



15-025-11 11.5 cm
15-026-13 13 cm
15-027-14 14.5 cm
15-028-16 16 cm
15-029-18 18 cm
15-030-20 20 cm
1 mm Ø



FARRELL
(Lathbury-Uebe)
15-032-12 12 cm 0.9 mm Ø
15-033-14 14 cm 0.9 mm Ø
15-034-16 16.5 cm 1.1 mm Ø



15-036-14 14.5 cm
15-037-14 16 cm



15-039-13 13 cm
15-040-14 14.5 cm
15-041-16 16 cm



16

Cardiovascular
Herz - und Gefabchirurgie
Cirugia Cardiovascular



ANDERSON-ADSON
16-010-20 20 cm sharp
16-011-20 20 cm blunt

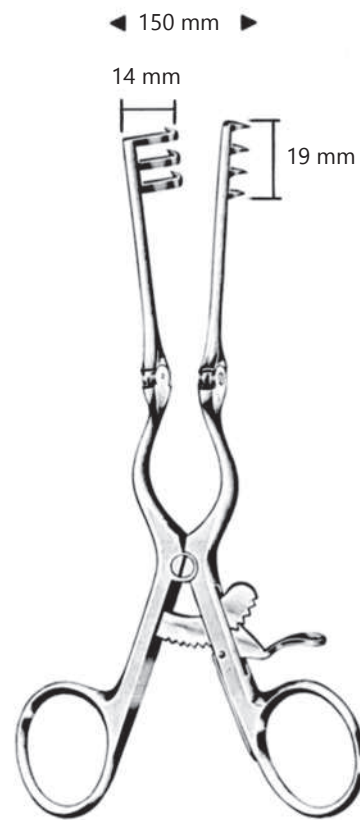

ADSON-BABY
16-013-16 16 cm sharp
16-014-16 16 cm blunt

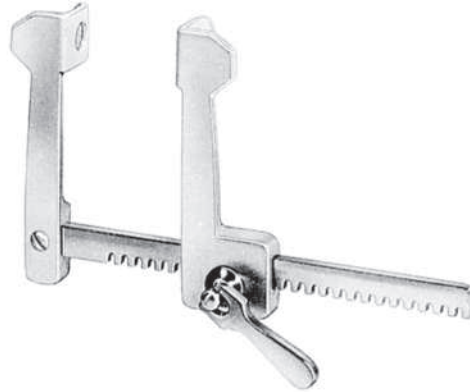
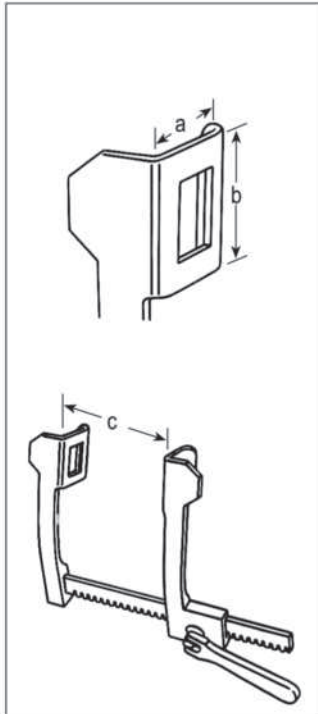

FINOCCHIETTO-INFANT
 a b c
 16-016-01 15 mm 15 mm 75 mm

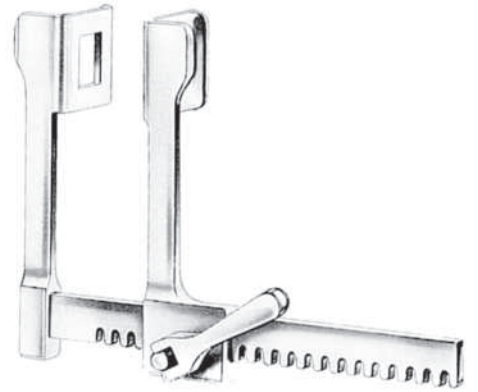

FINOCCHIETTO-BABY
 a b c
 16-018-75 18 mm 20 mm 75 mm



FINOCCHIETTO
 a b c
 16-020-01 40 mm 40 mm 165 mm
 16-021-02 45 mm 65 mm 200 mm
 16-022-03 70 mm 65 mm 250 mm



BAILEY-BABY
 16-024-14
 14 cm

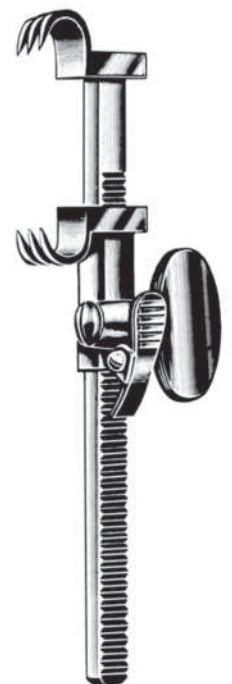

BAILEY
 16-026-16
 16 cm

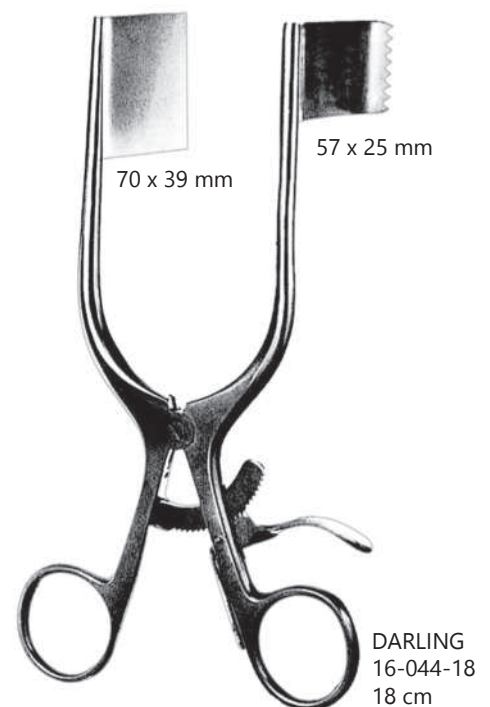
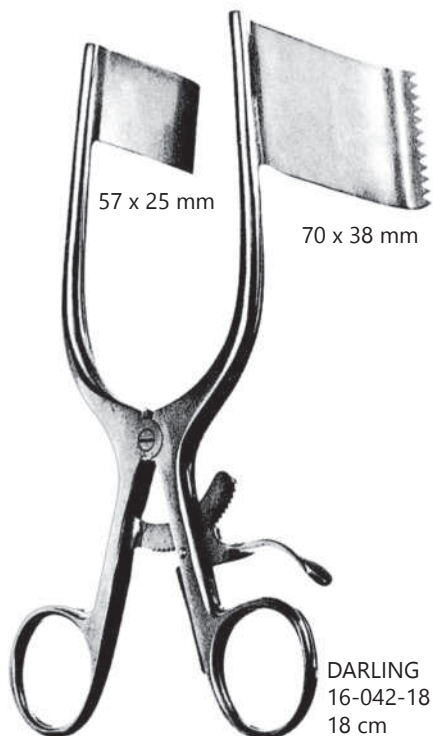
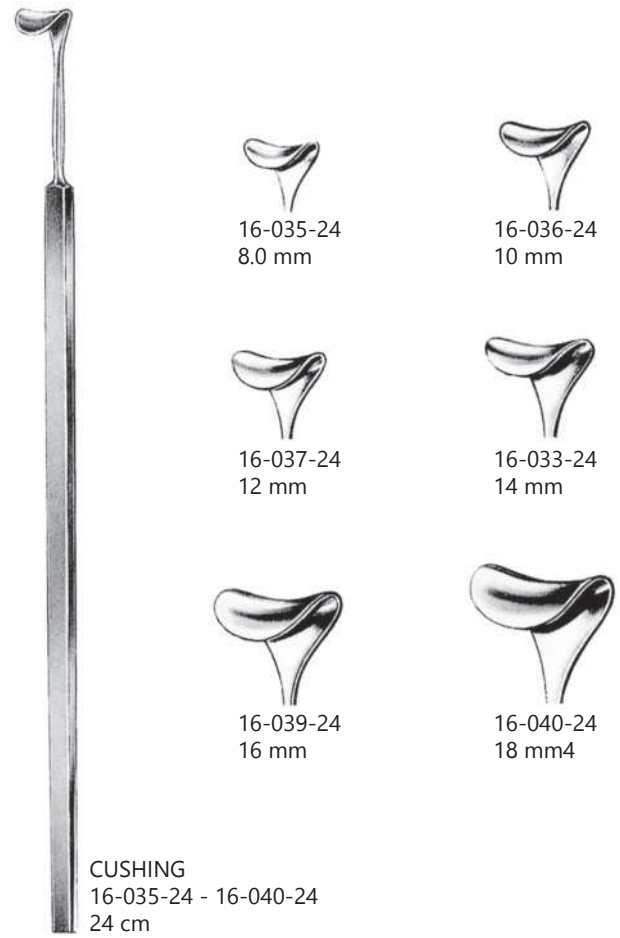
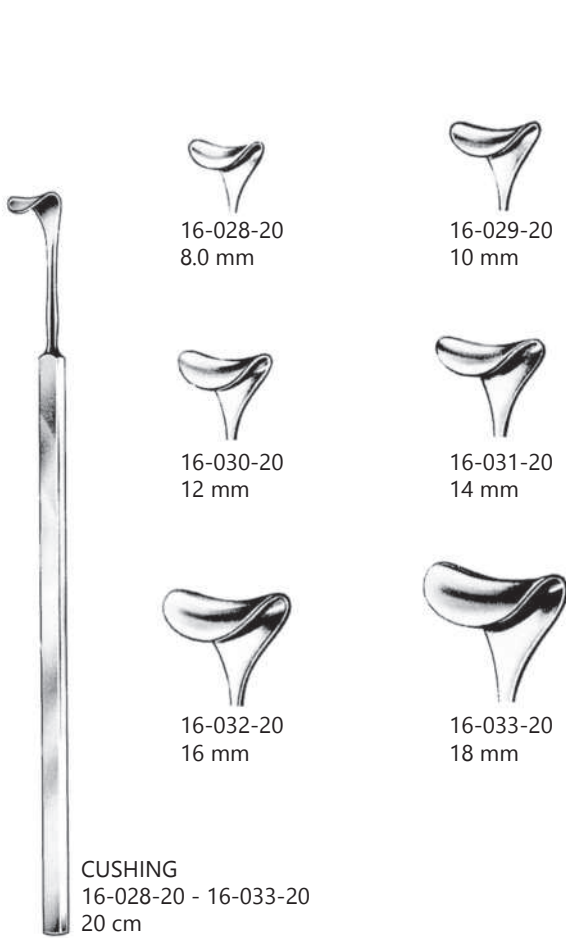



16-046-01
Fig-1



16-047-02
Fig-2

CUSHING
 16-046-01 - 16-047-02
 19 cm



16-049-01
Fig-1



16-050-02
Fig-2

CUSHING
 16-049-01 - 16-050-02
 28 cm



16-052-01
Fig-1



16-053-02
Fig-2

CRILE
 16-053-01 - 16-053-02
 20 cm



DEAVER
16-055-18
18 cm

DEAVER
16-057-21
21.5 cm

DEAVER
16-059-23
23 cm

DEAVER
16-061-30
30 cm

DEAVER
16-063-33
33 cm

DEAVER
16-065-36
36 cm



DEAVER	L	B
16-067-30	30.5 cm	25 mm
16-068-33	33 cm	25 mm
16-069-30	30.5 cm	38 mm
16-070-30	30.5 cm	50 mm
16-071-30	30.5 cm	75 mm

DEAVER
16-073-30
30 cm

DEAVER
16-075-30
30 cm

DEAVER
16-077-30
30 cm



POLLOSON
16-079-27
27 cm

POLLOSON
16-081-27
27 cm

HARRINGTON
16-083-32 32 cm 127 x 40 mm
16-084-32 32 cm 127 x 62 mm
16-085-32 32 cm 175 x 64 mm

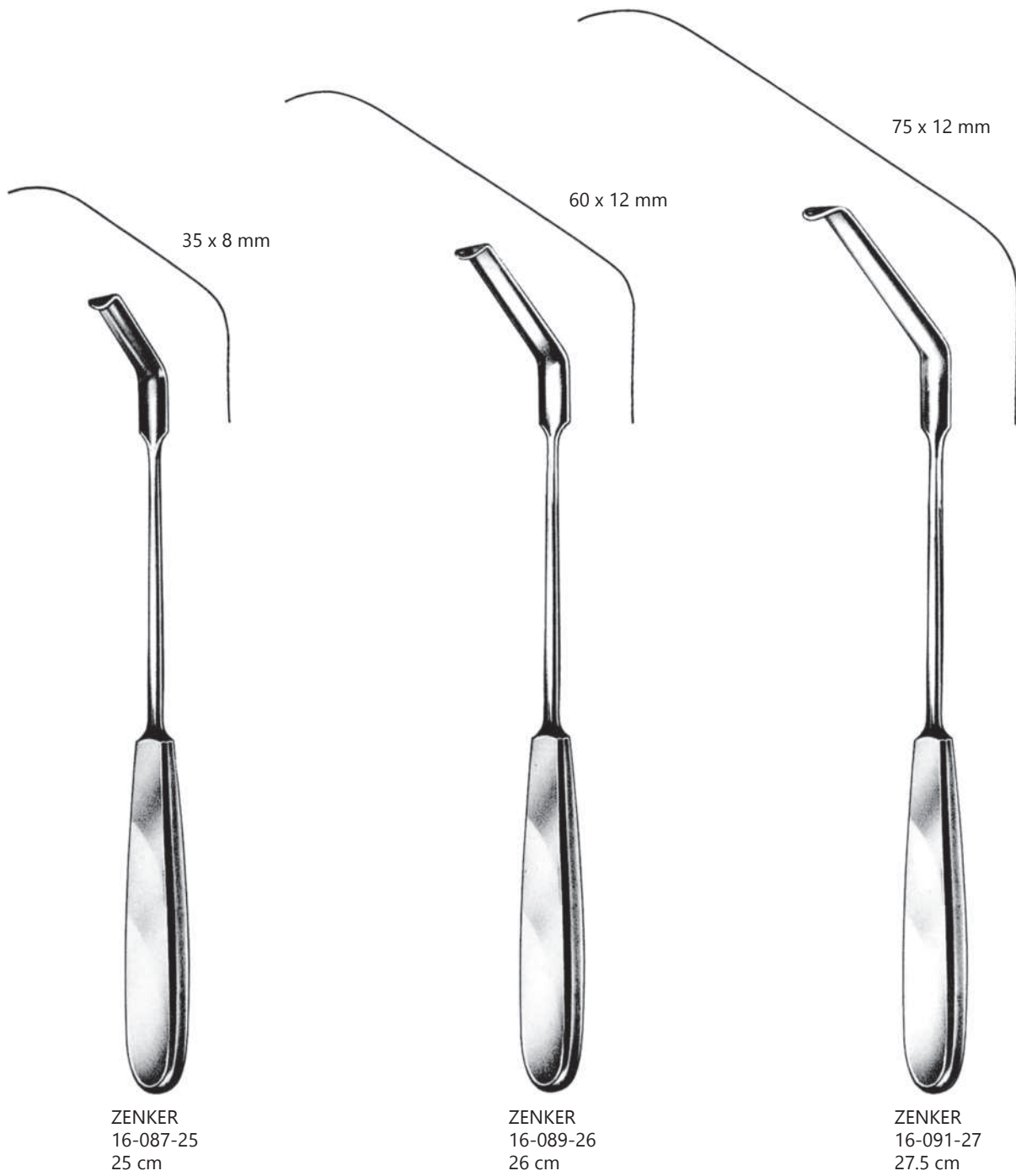



ROSS
16-093-01 - 16-098-06
27 cm



16-093-01
fig-1



16-094-02
fig-2



16-095-03
fig-3



16-096-04
fig-4



16-097-05
fig-5



16-098-06
fig-6



CRAWFORD
16-100-01 - 16-101-02
19 cm



16-100-01
15 x 15 mm

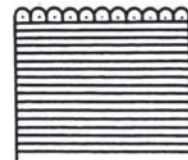

16-101-02
15 x 23 mm



DOYEN
 16-103-17 - 16-104-17
 17 cm

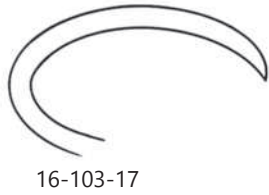

16-103-17

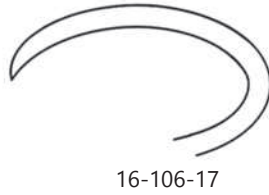

16-106-17



16-104-17



16-107-17



DOYEN
 16-106-17 - 16-107-17
 17 cm

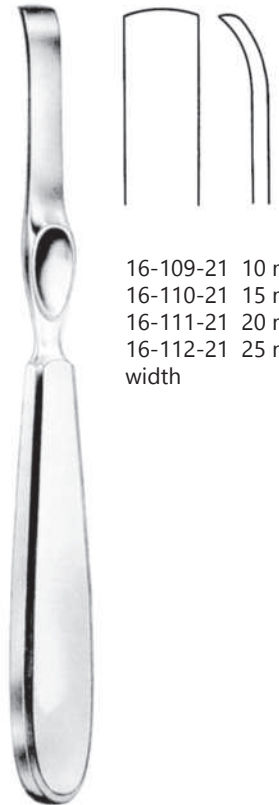

LAMBOTTE
 16-109-21 - 16-112-21
 21 cm







16-109-21 10 mm
 16-110-21 15 mm
 16-111-21 20 mm
 16-112-21 25 mm
 width



STILLE
 16-114-21
 21 cm



16-116-22
 22 cm

							
		16-118-08	16-119-10	16-120-12	16-121-08	16-122-10	16-123-12
	length	50 mm	50 mm	60 mm	50 mm	50 mm	60 mm
	jaws	08 mm	10 mm	12 mm	08 mm	10 mm	12 mm
	weight	03 gr.	03 gr.	03 gr.	03 gr.	03 gr.	03 gr.
pressure	50 gr.	50 gr.	50 gr.	50 gr.	50 gr.	50 gr.	

16-118-08 - 16-123-12

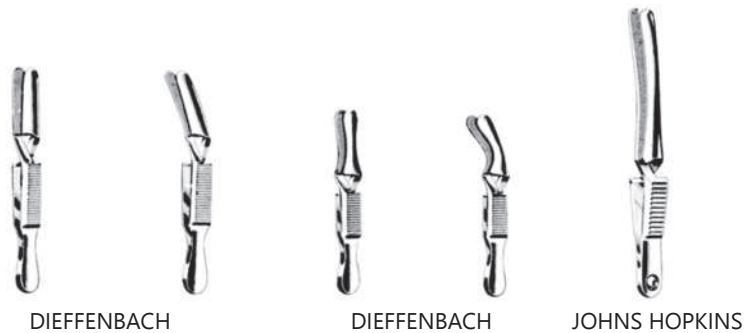

	DIEFFENBACH		DIEFFENBACH		JOHNS HOPKINS
cm					
3.5			16-125-03	16-126-03	
5.0			16-128-05	16-129-05	16-130-05
6.0	16-132-06	16-133-06			
6.5					16-135-06
7.5					16-137-07

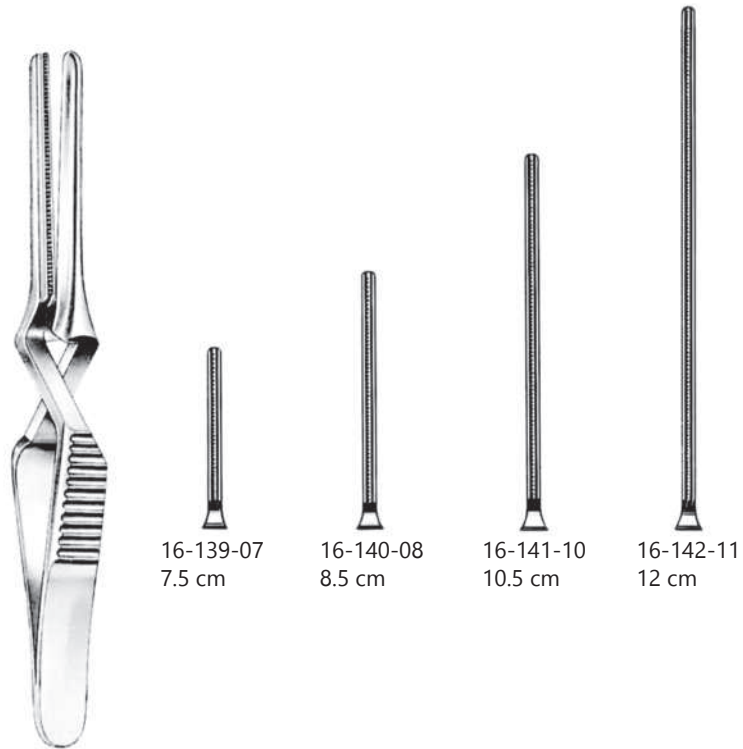

16-139-07 - 16-142-12

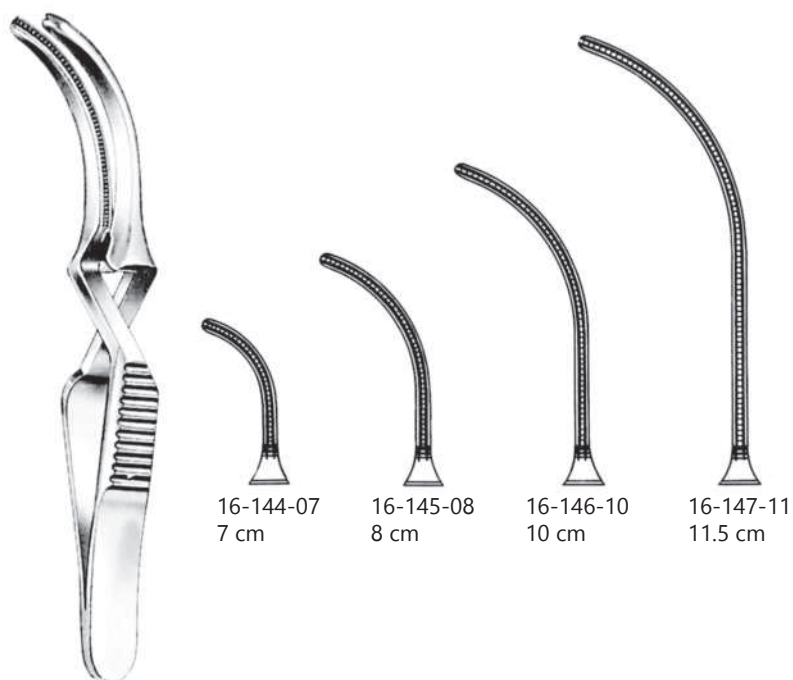

16-144-07 - 16-147-12



GLOVER
16-149-06
5 cm



SANTULLI
16-151-07
7 cm



GREGORY-SOFT
16-153-09 - 16-154-11



16-153-09
9 cm



16-154-11
11 cm



DE BAKEY - SATINSKY
16-156-10
10 cm



DE BAKEY - CAROTID
16-158-09
9 cm



16-158-09
9 cm

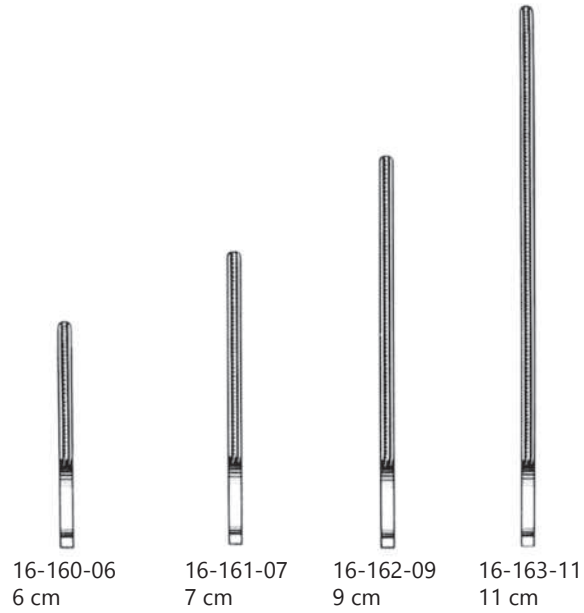

GLOVER
 16-160-06 - 16-163-11

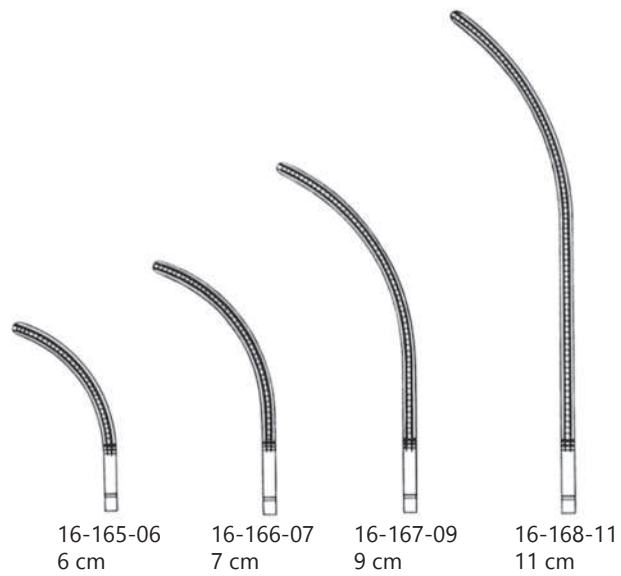

GLOVER
 16-165-06 - 16-168-11

1.5 mm



16-170-16 16 cm
 16-171-20 20 cm
 16-172-24 24 cm

DE BAKEY
 16-170-16 - 16-172-24

2 mm



16-174-16 16 cm
 16-175-20 20 cm
 16-176-24 24 cm
 16-177-30 30 cm

DE BAKEY
 16-174-16 - 16-177-30

2 mm

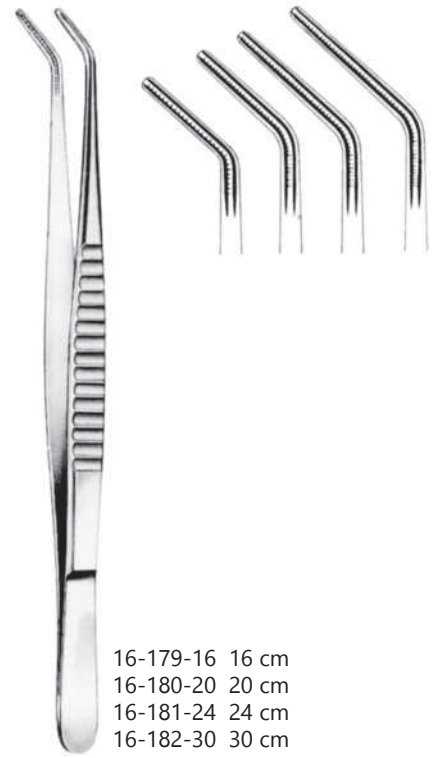

16-179-16 16 cm
 16-180-20 20 cm
 16-181-24 24 cm
 16-182-30 30 cm

DE BAKEY
 16-179-16 - 16-182-30

2 mm



16-184-16 16 cm
 16-185-20 20 cm

COOLEY
 16-184-16 - 16-185-20

2.7 mm



16-184-16 16 cm
 16-185-20 20 cm
 16-189-24 24 cm
 16-190-30 30 cm

DE BAKEY
 16-187-16 - 16-190-30

3.5 mm

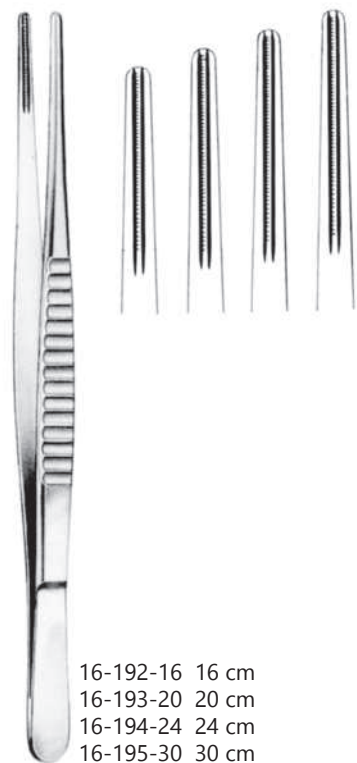

16-192-16 16 cm
 16-193-20 20 cm
 16-194-24 24 cm
 16-195-30 30 cm

DE BAKEY
 16-192-16 - 16-195-30



DE BAKEY
16-197-28
28 cm

DE BAKEY
16-198-30
30 cm



DE BAKEY
16-200-16
16 cm



DE BAKEY
16-202-19 - 16-203-23



16-202-19
19 cm



16-203-23
23 cm



DE BAKEY
16-205-24
24 cm



16-207-21
21 cm

16-208-22
22 cm

POTTS
 16-207-22 - 16-208-22

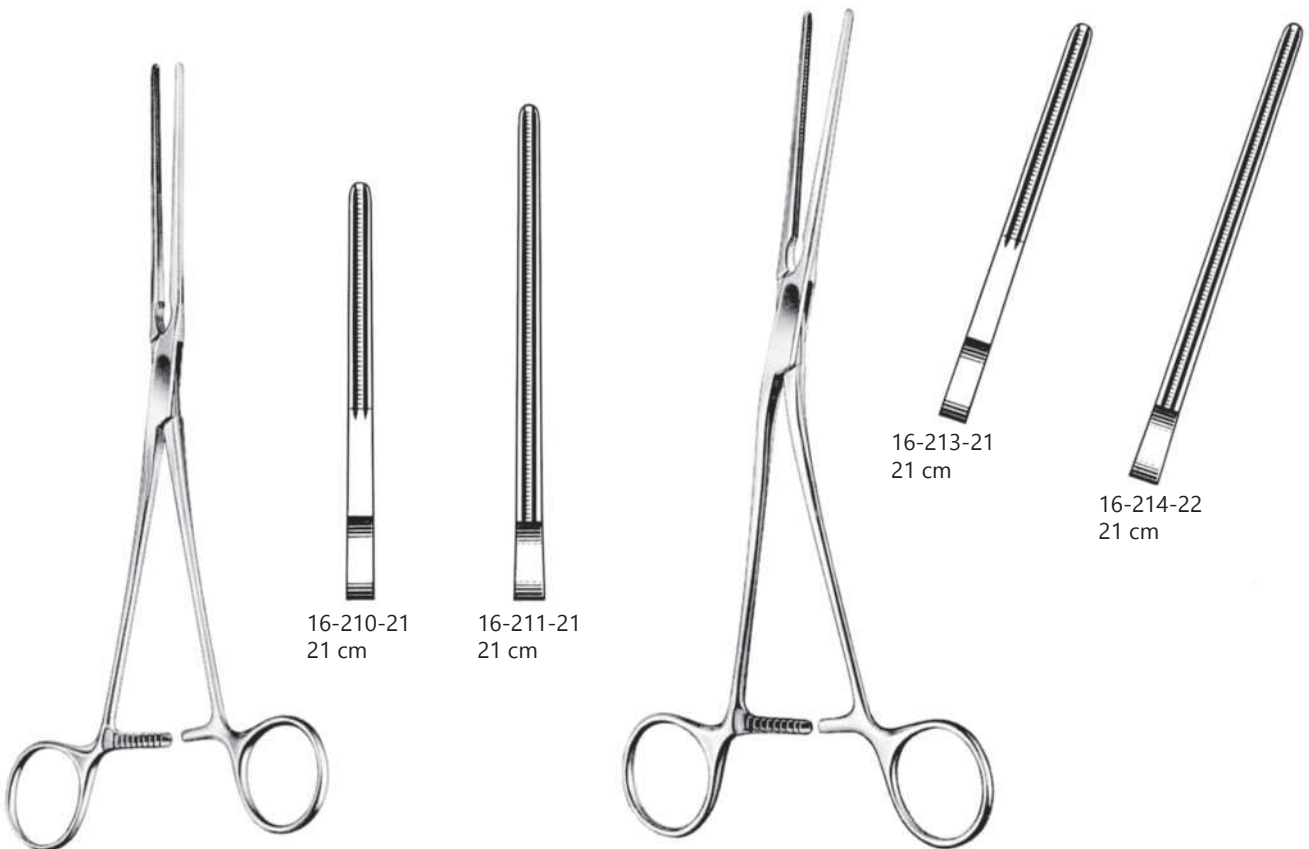

16-210-21
21 cm

16-211-21
21 cm

16-213-21
21 cm

16-214-22
21 cm

POTTS
 16-210-21 - 16-211-22

POTTS
 16-213-21 - 16-214-22



16-216-19
19 cm



16-217-20
20 cm

DE BAKEY
16-216-19 - 16-217-20



POTTS
16-219-22
22 cm



POTTS
16-221-22
22 cm

16-221-22
22 cm



DE BAKEY
16-223-25
25 cm



DE BAKEY
16-224-26
26 cm



LEES
16-227-25
25 cm



LEES
16-229-23 - 16-230-25
23 cm



16-229-23
23 cm



16-230-25
25 cm

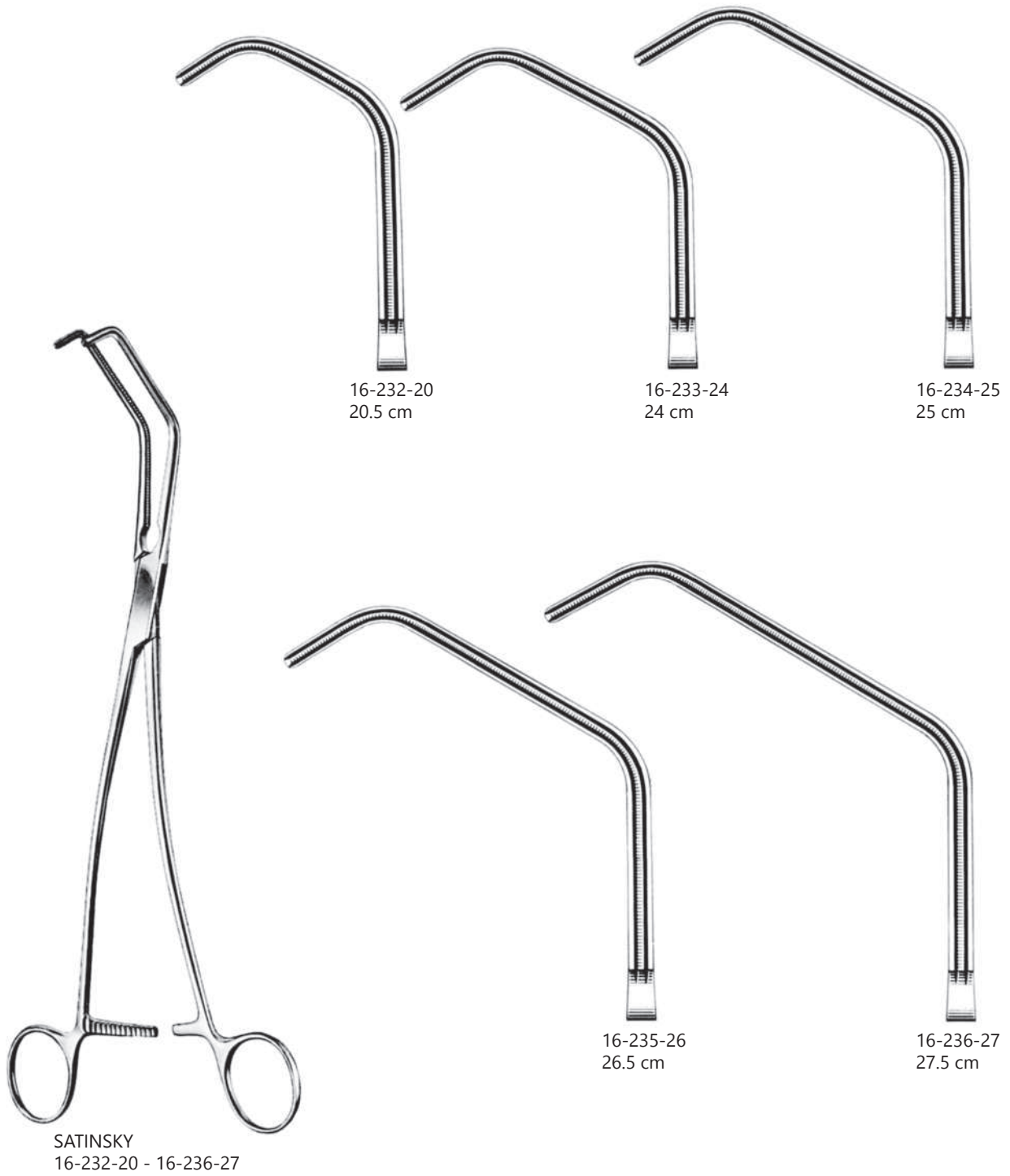

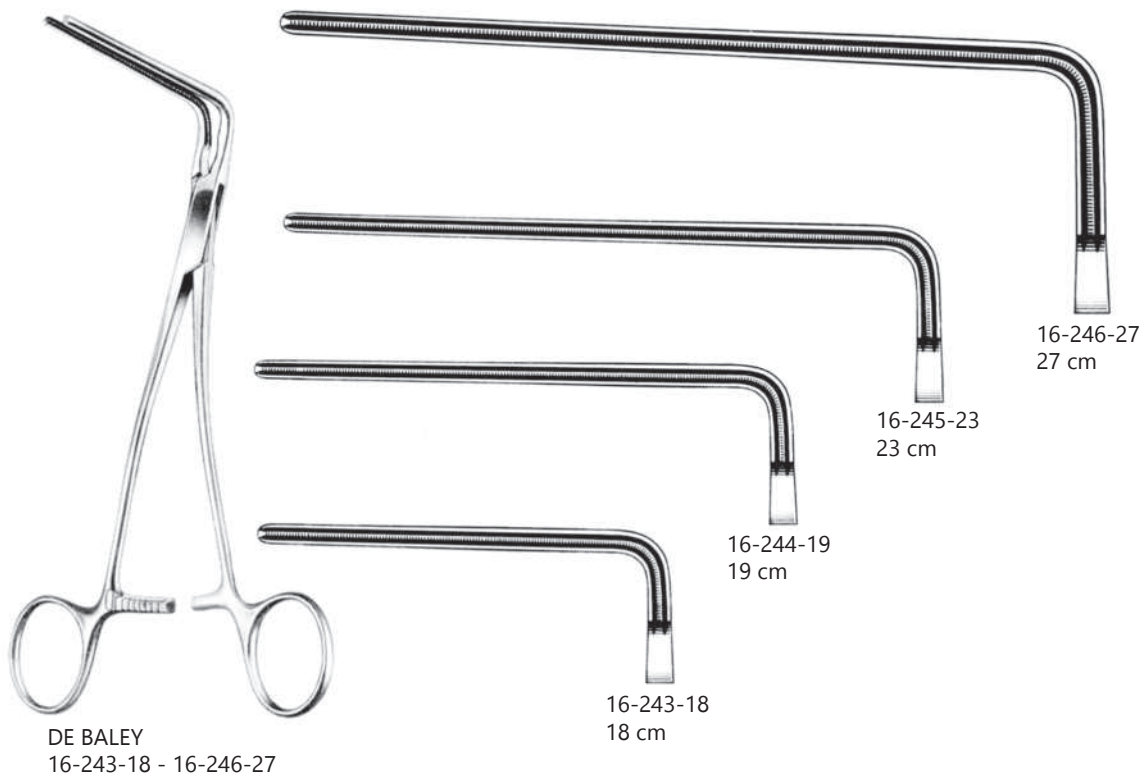
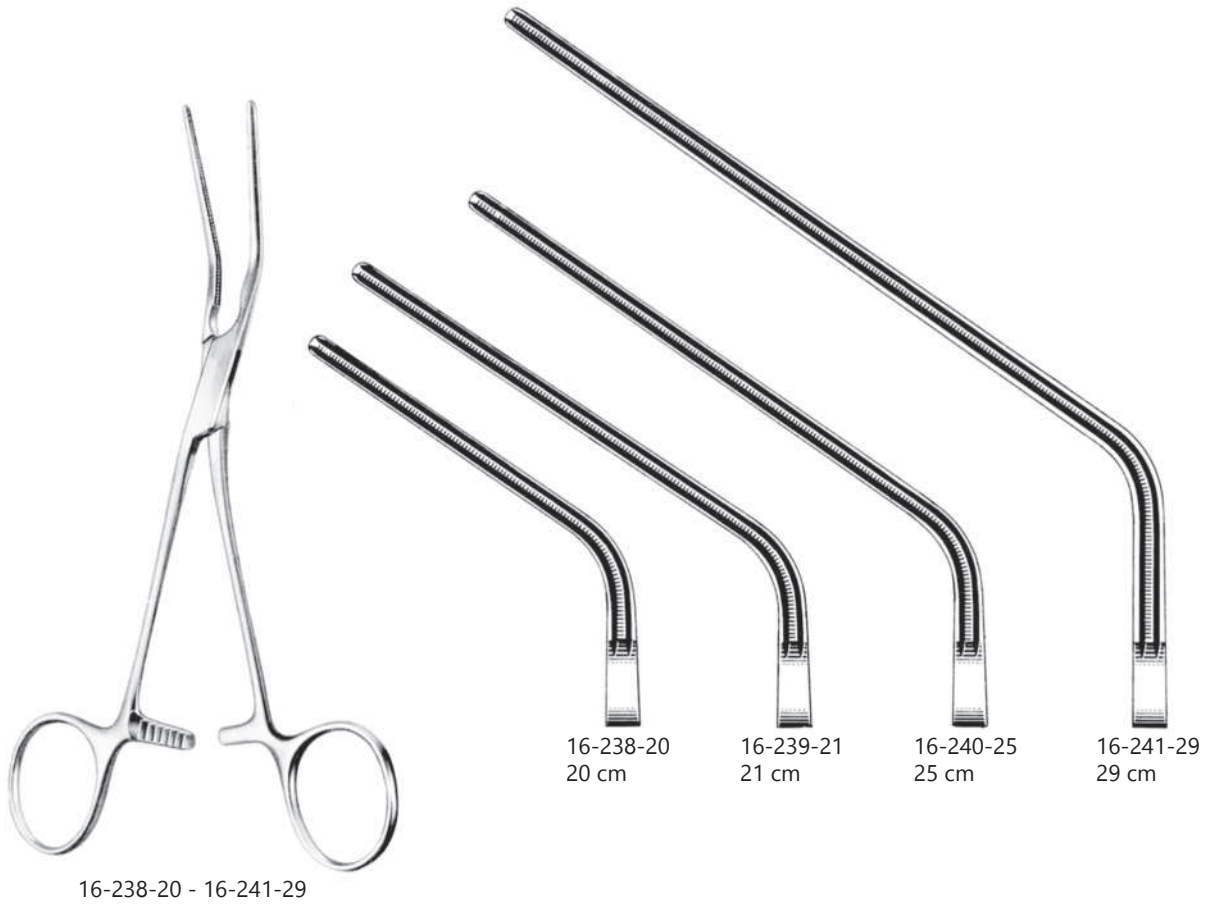



16-248-21 - 16-251-31



16-248-21
21 cm



16-249-23
23 cm



16-250-27
27 cm



16-251-31
31 cm



16-253-21 - 16-256-31



16-253-21
21 cm



16-254-23
23 cm



16-255-27
27 cm



16-256-31
31 cm

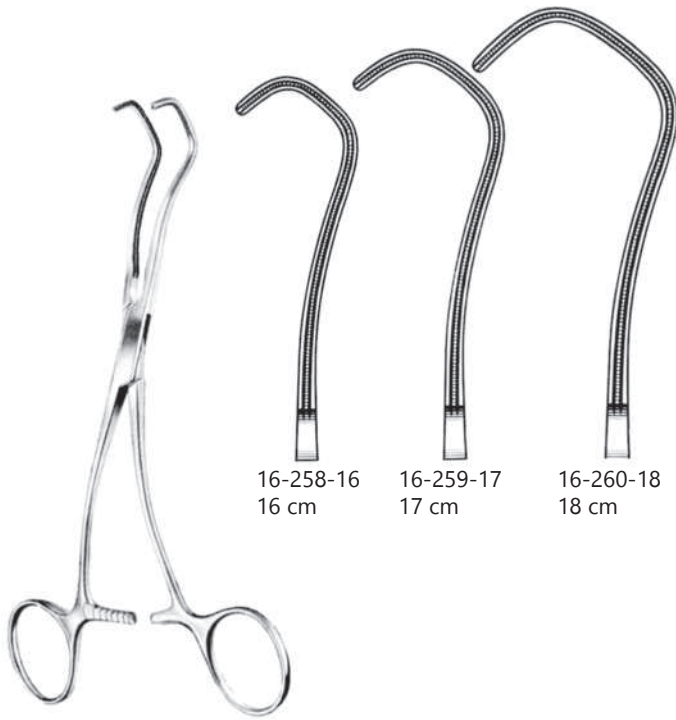

16-258-16
16 cm

16-259-17
17 cm

16-260-18
18 cm

DERRA
16-258-16 - 12-260-18



BECK
16-262-17
17 cm



GLOVER
16-264-17
17 cm

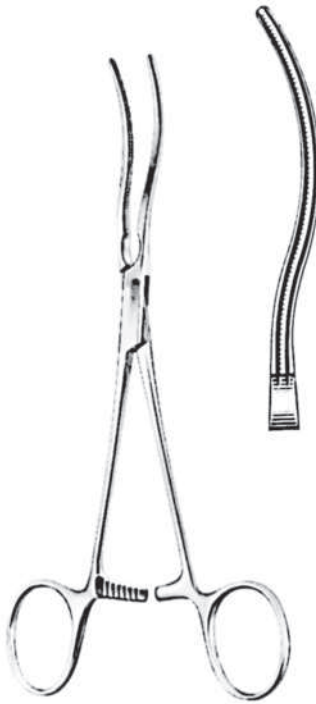

16-266-17
17 cm



DE BAKKEY
16-268-17
17 cm



DE BAKEY
 16-270-16 - 16-271-17



COOLEY
 16-273-16 - 16-274-17



COOLEY
 16-276-17
 17 cm



COOLEY
 16-278-16
 16 cm



BECK
 16-280-17
 17 cm



DE BAKEY
16-282-10
10 cm



DE BAKEY
16-284-12
12 cm



DE BAKEY
16-286-11
11 cm



DE BAKEY
16-288-12
12 cm



DE BAKEY
16-290-13
13 cm

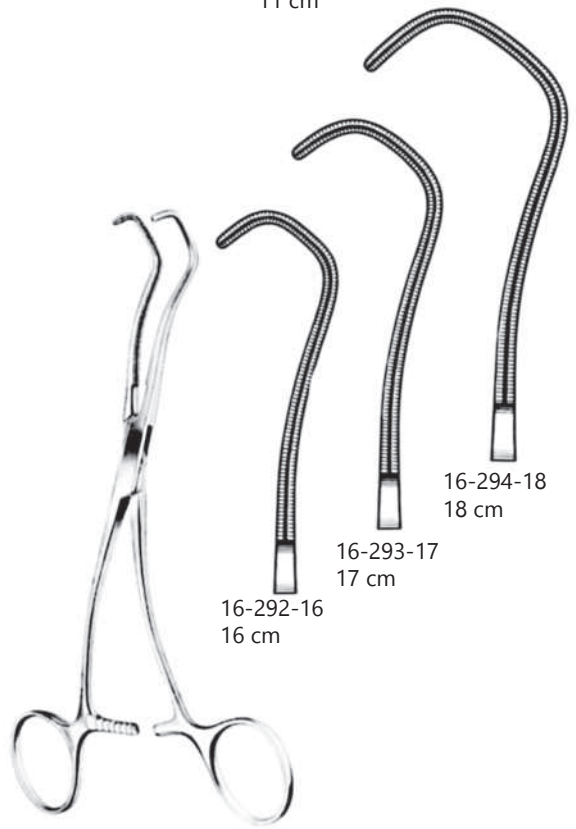

COLLEY-DERRA
16-292-16 - 16-294-18



COOLEY
 16-296-17
 17 cm



COOLEY
 16-298-17
 17 cm



COOLEY
 16-300-17
 17 cm



COOLEY
 16-302-17
 17 cm

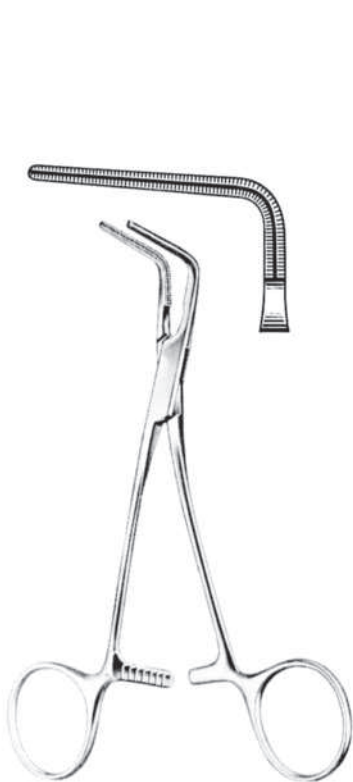

COOLEY
 16-304-15
 15 cm



COOLEY
 16-306-16
 16 cm



COOLEY
 16-308-17
 17 cm



DE BAKEY-MOSQUITO
16-310-12
12 cm



DE BAKEY-MOSQUITO
16-312-12
12 cm

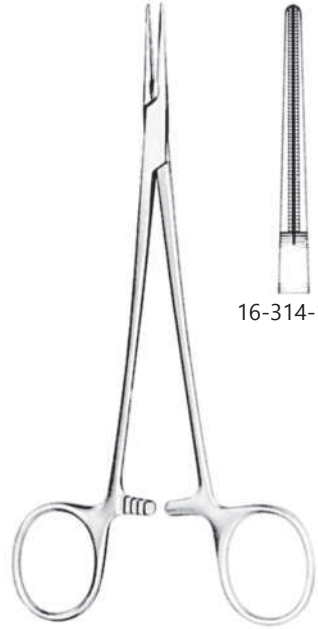

DE BAKEY-RANKIN
16-314-16 - 16-315-16
16 cm



16-314-16



16-315-16



DE BAKEY-MOSQUITO
16-317-15 - 16-318-15
15 cm



DE BAKEY
16-320-15
15 cm



DE BAKEY
16-322-17
17 cm



DE BAKEY
 16-324-16
 16 cm



DE BAKEY
 16-326-15
 15 cm



16-328-16
 14 cm

16-329-16
 16 cm

16-330-18
 18 cm

16-331-20
 20 cm

16-333-14
 14 cm

16-334-16
 16 cm

16-335-18
 18 cm

16-336-20
 20 cm

DE BAKEY-PEAN
 16-328-14 - 16-331-20

DE BAKEY-PEAN
 16-333-14 - 16-336-20

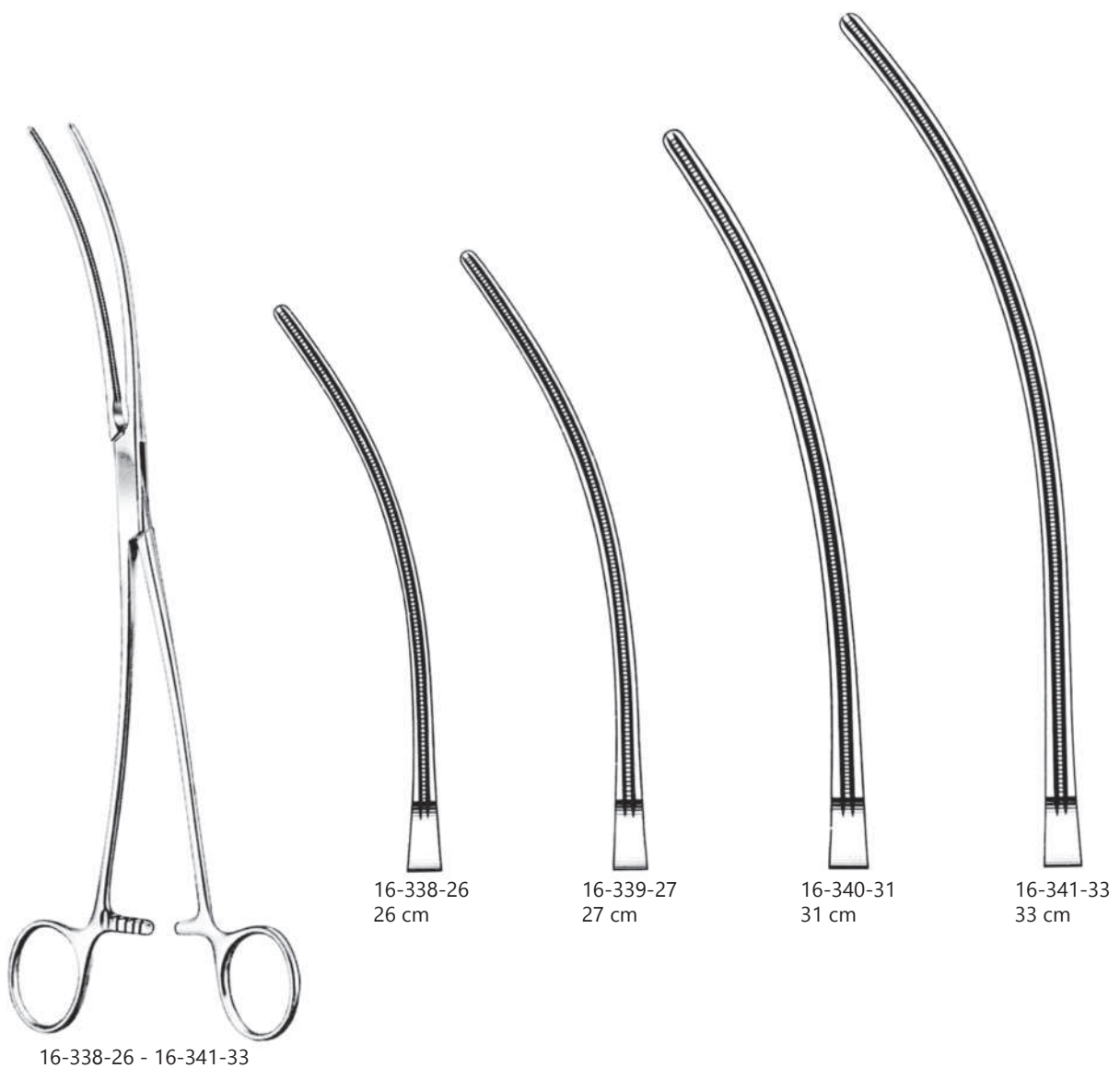



16-343-18 - 16-346-18
18 cm



16-343-18
25°



16-344-18
45°



16-345-18
60°



16-346-18
90°



16-348-18 - 16-351-18
18 cm



16-348-18
25°



16-349-18
45°



16-350-18
60°



16-351-18
90°



FAVALCIO
 16-353-15
 15 cm

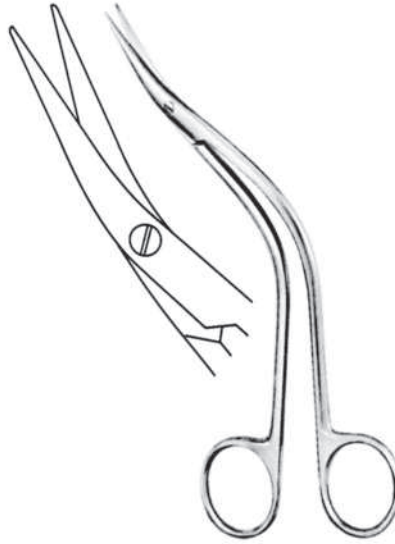

DE BAKEY
 16-355-15
 15.5 cm
 blunt

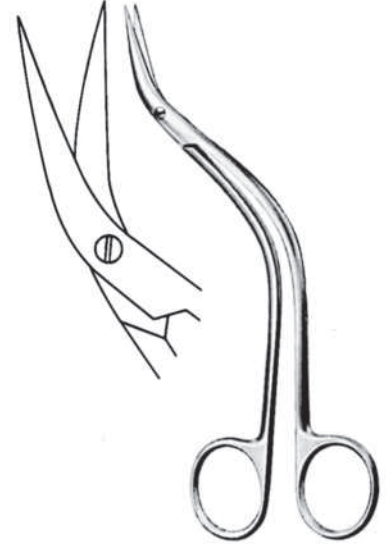

DE BAKEY
 16-357-15
 15.5 cm
 sharp



POTTS-SMITH
 16-363-19 - 16-364-19
 19 cm



16-359-19
 25°

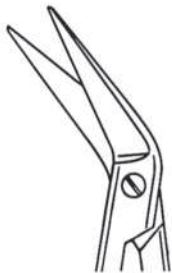

16-360-19
 40°



16-361-19
 60°



POTTS-DEMARTEL
 16-366-21 - 16-367-24



16-366-21 21 cm
 16-367-24 24 cm

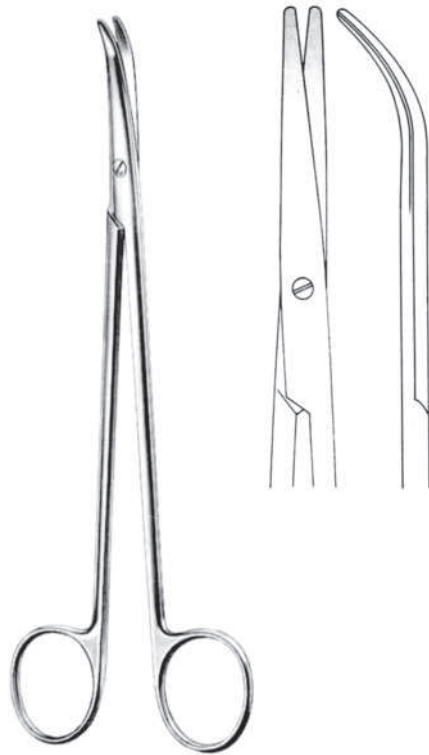

THOREK
 16-369-19
 19 cm

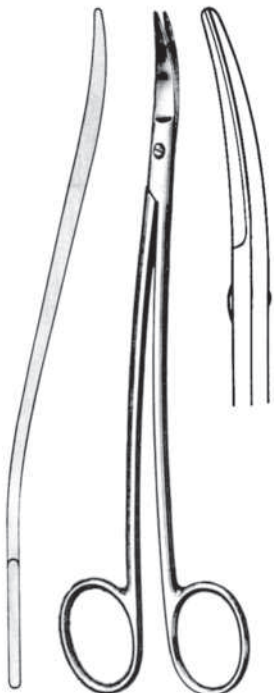

SATINSKY
 16-371-18
 18 cm



KLINKENBERGH
 16-373-23
 23 cm

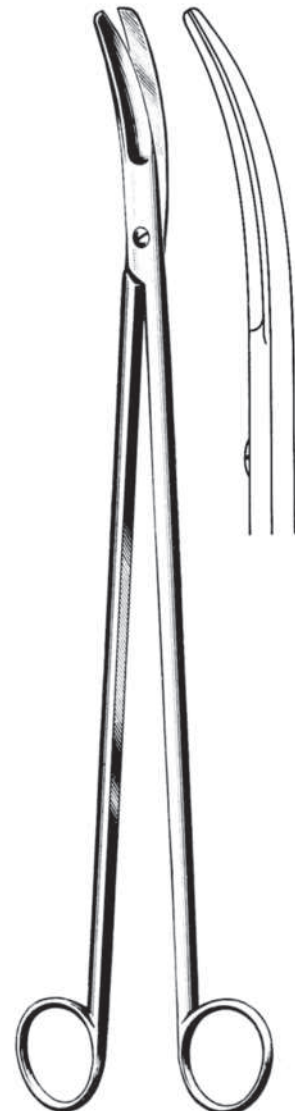

CRAFOORD
 16-375-30
 30 cm



DIETRICH
16-377-18 - 16-381-17



16-377-18
18 cm



16-378-18
18 cm



16-379-18
17.5 cm



16-380-17
17 cm



16-381-17
17 cm



DE BAKEY
(Potts-Smith)
16-383-19 - 16-385-19
19 cm

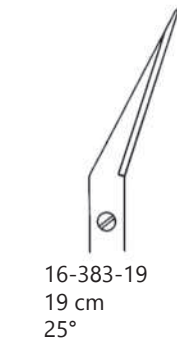

16-383-19
19 cm
25°

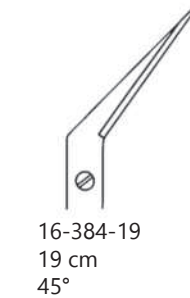

16-384-19
19 cm
45°

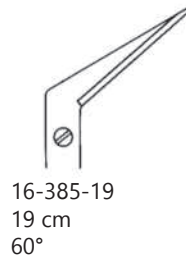

16-385-19
19 cm
60°

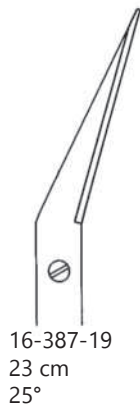

16-387-19
23 cm
25°

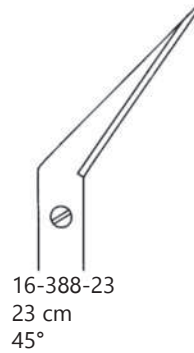

16-388-23
23 cm
45°

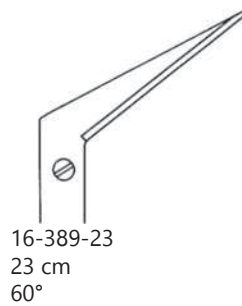

16-389-23
23 cm
60°



DE BAKEY
(Potts-Smith)
16-387-23 - 16-389-23
23 cm



METZENBAUM FIND
 16-391-18 - 16-393-23



16-391-18
 18 cm



16-392-20
 20 cm

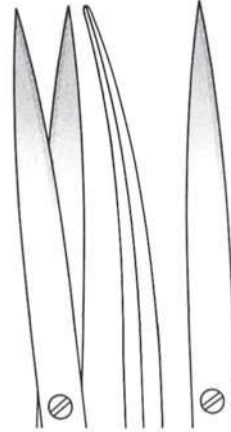

16-393-23
 23 cm

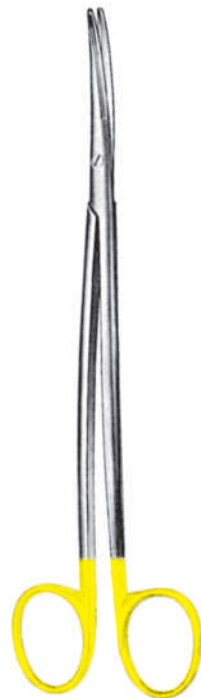

METZENBAUM FIND
 16-395-18 - 16-397-23

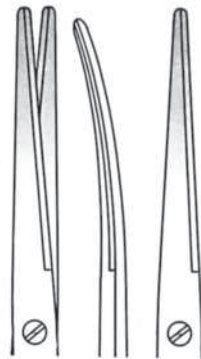

16-395-18
 18 cm
 S - shaped



16-396-20
 20 cm
 S - shaped



16-397-23
 23 cm
 S - shaped

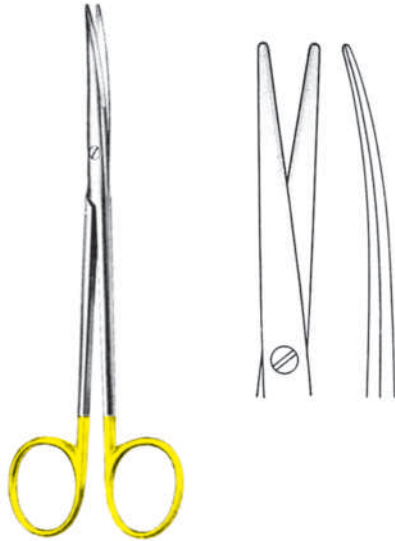

TOENINS-ADSON
 16-399-17
 17 cm



METZENBAUM-LAHEY
 16-401-14
 14 cm

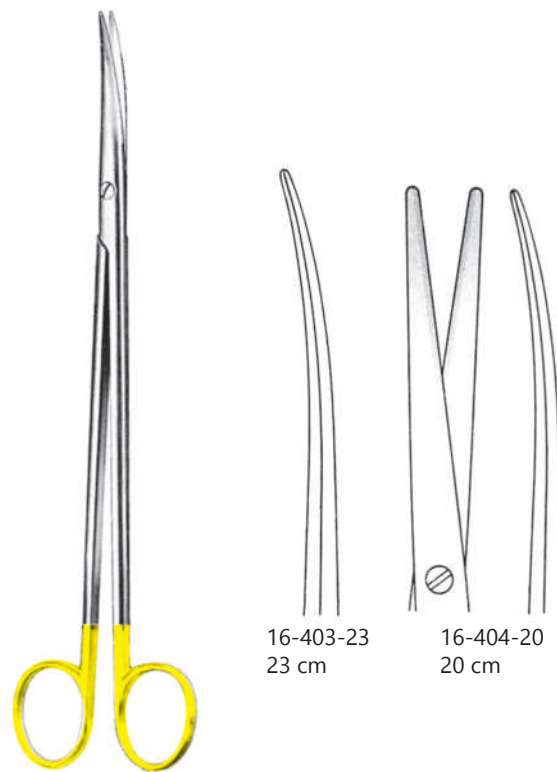

16-403-23
 23 cm

16-404-20
 20 cm

METZENBAUM-LAHEY
 16-403-23 - 16-404-20

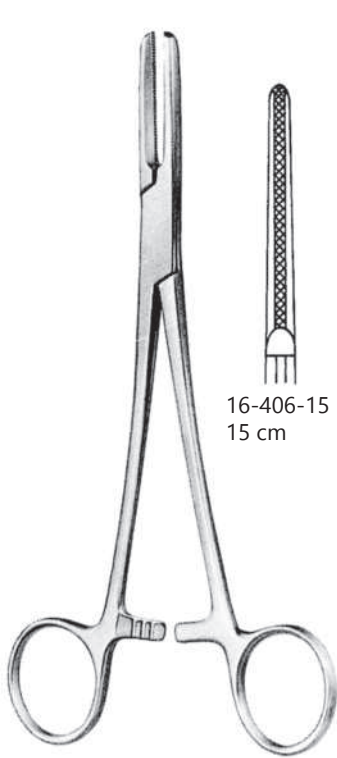

16-406-15
15 cm



16-407-18
18 cm



16-408-20
20 cm



16-406-15 - 16-408-20

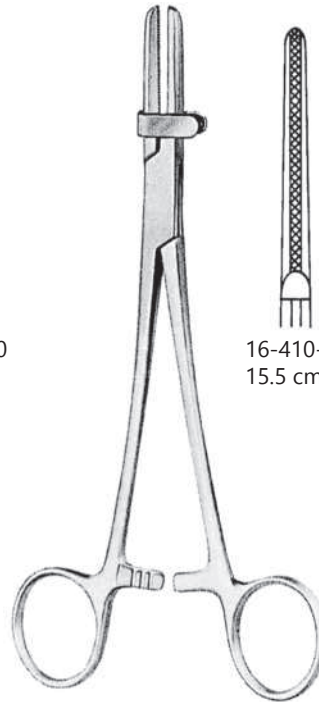

16-410-15
15.5 cm



16-411-18
18 cm



16-412-20
20 cm



16-410-15 - 16-412-20

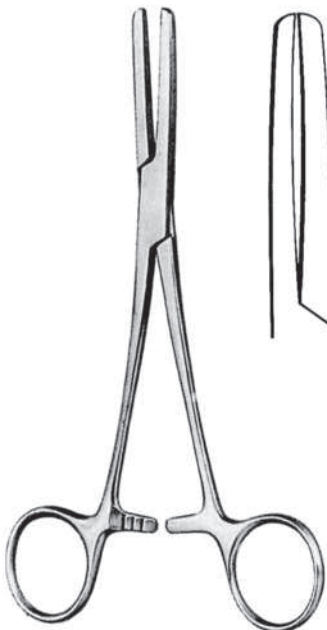

PRESBYTERIAN
16-414-16 16 cm
16-415-18 18 cm



KLINIKUM BERLIN
16-417-14
14.5 cm





PRESBYTERIAN
16-414-16 16 cm
16-415-18 18 cm



16-419-13
13 cm



16-420-18
13 cm



16-421-20
20 cm



16-422-23
23 cm



16-423-28
28 cm

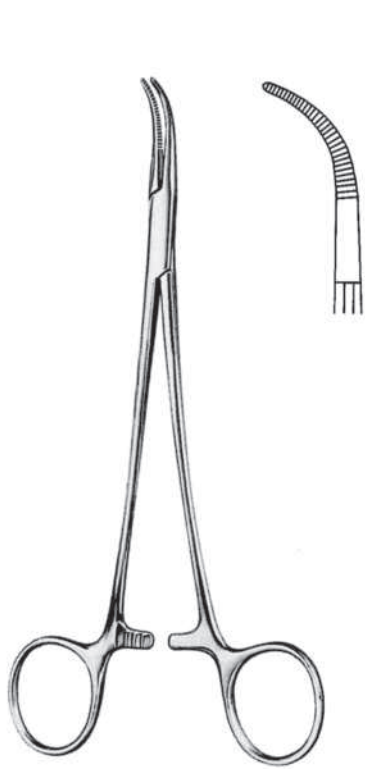

OVERHOLT
 16-425-16
 16.5 cm



OVERHOLT
 16-427-20
 20.5 cm



OVERHOLT
 16-429-21
 21.5 cm

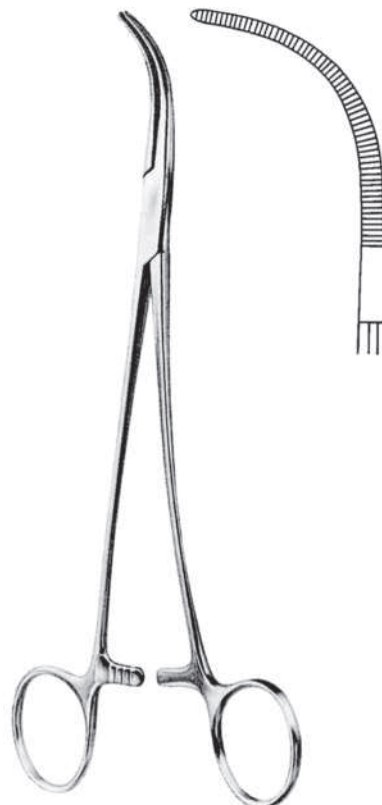

OVERHOLT
 16-431-21
 21.5 cm





LOVELACE
16-433-20
20 cm



LOVELACE
16-435-20
20 cm



16-437-25 - 16-438-26



16-437-25
25 cm



16-438-26
26 cm



16-440-18 - 16-442-23



16-440-18
18 cm



16-441-20
20 cm

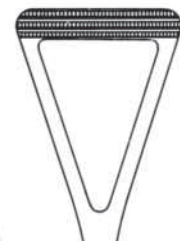

16-442-23
23 cm



SEMB
 16-444-24
 24 cm



PRICE-THOMAS
 16-446-22
 22 cm



PRICE-THOMAS
 16-448-22
 22 cm



ALLIS-ATRAUMA
 16-450-16 - 15-453-30

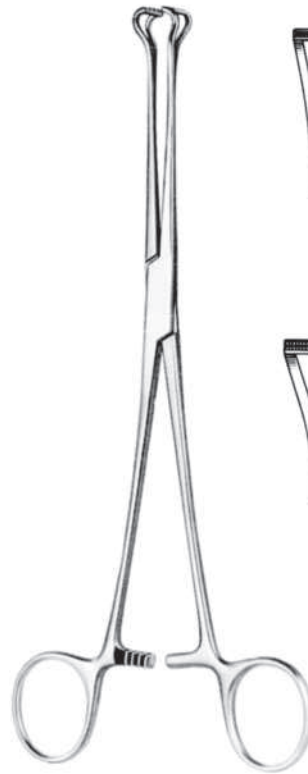

BABCOCK-ATRAUMA
 16-455-16 - 15-456-20

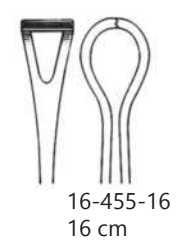



MICRO VASCULAR
 16-458-14 - 16-461-23

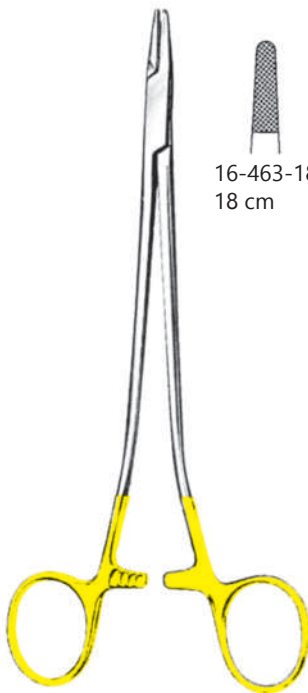
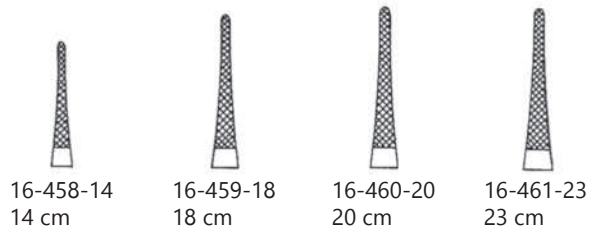

SAROT
 16-463-18 - 16-465-26

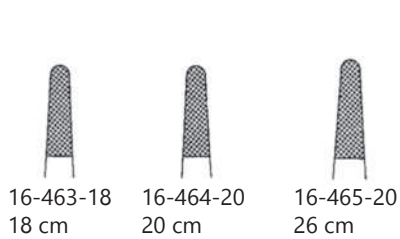

DE BAKEY
 16-467-16 - 16-472-37

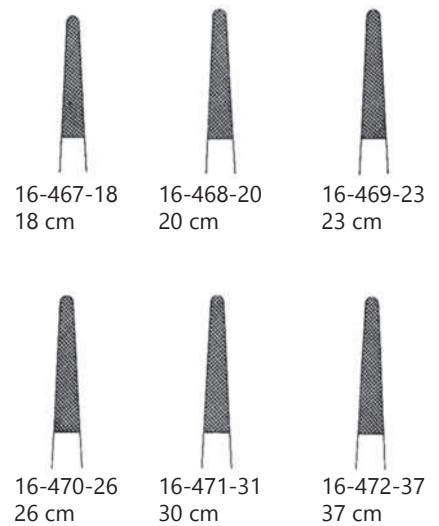



RYDER VASCULAR
 16-474-13 - 16-479-26

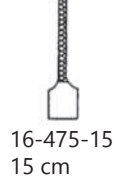
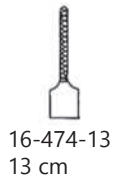

STERNUM
 16-481-13 - 16-482-18



16-484-15 - 16-485-18

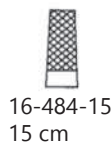

16-487-19
18.5 cm





POTTS-SMITH
 16-489-22
 22 cm



HEPP-SCHIEDEL
 16-491-18
 18 cm



CASTROVIEJO
 16-491-18 - 16-498-21



16-493-14
 14 cm
 smooth



16-494-18
 18 cm
 Micro profile



16-495-21
 21 cm
 Micro profile



16-496-14
 14 cm
 smooth



16-497-18
 18 cm
 Micro Profile



16-499-21
 21 cm
 Micro Profile



ROBB
 16-500-24
 24 cm



ROBB
 16-502-24
 24 cm



ROBB
 16-504-24
 24 cm



ROBB
 16-506-24
 24 cm

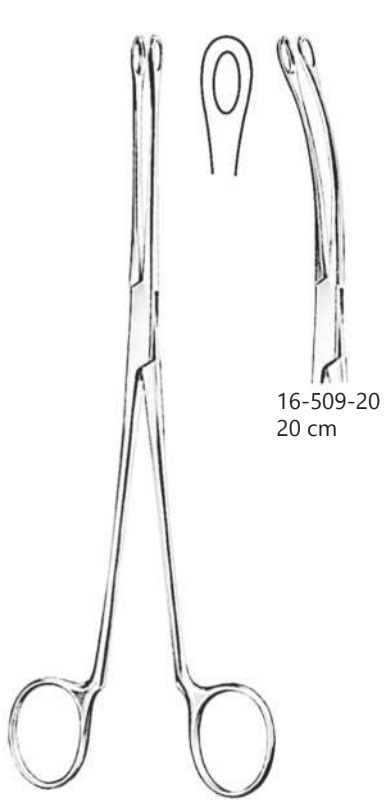

BIAKE
16-508-20
20 cm

16-509-20
20 cm



SACHS
16-511-21
21 cm



SACHS
16-513-21
21 cm

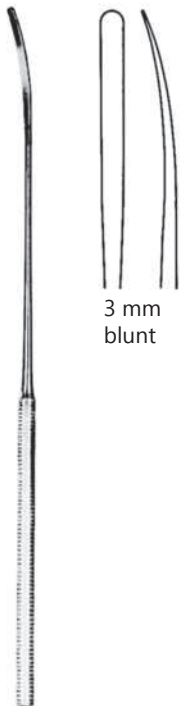

3 mm
blunt

16-515-18 18.5 cm
16-516-21 21.5 cm

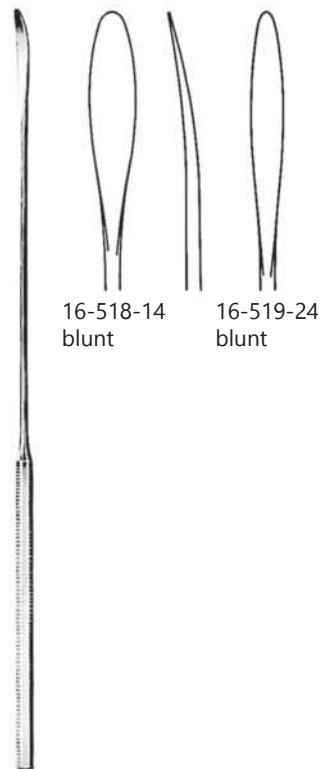

16-518-14
blunt

16-519-24
blunt

16-518-14 14.5 cm
16-519-24 23.5 cm

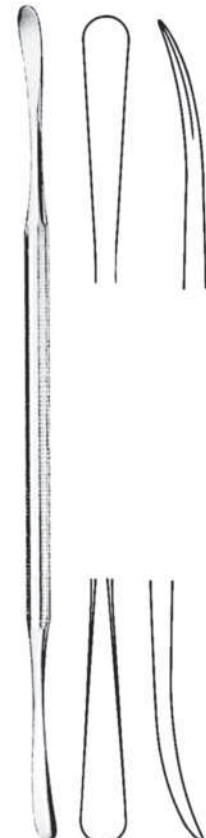

16-521-23
23 cm

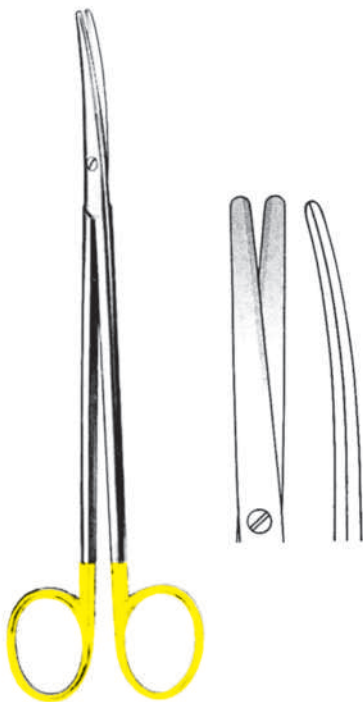

METZENBAUM-LAHEY
16-523-14
14 cm

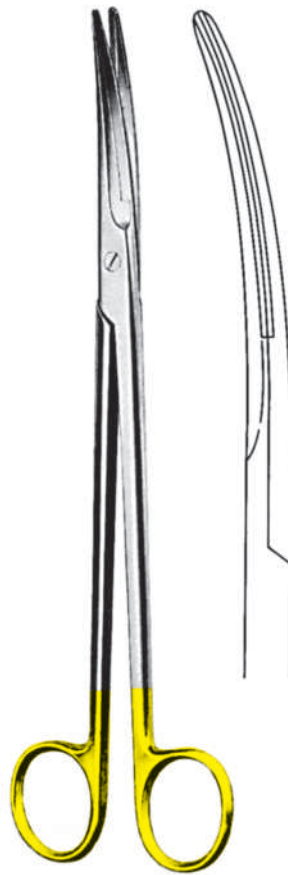

MAYO
16-525-23
23 cm

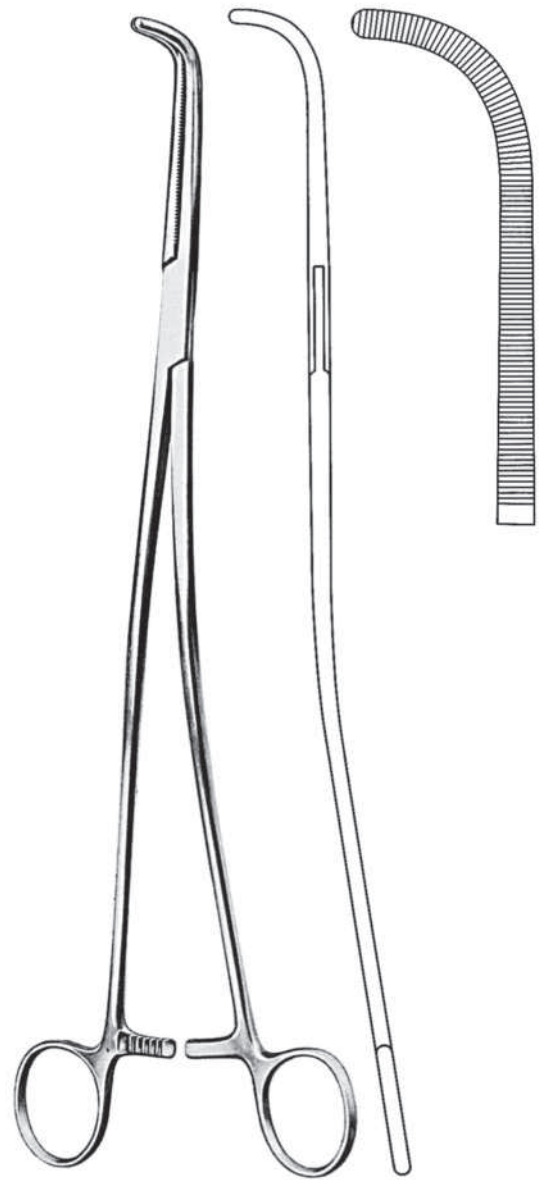

D'ALLAINES-BEAUJEAN
16-527-31
31 cm



DOYEN-BEAUJEAN
16-529-35 - 16-530-45
23 cm

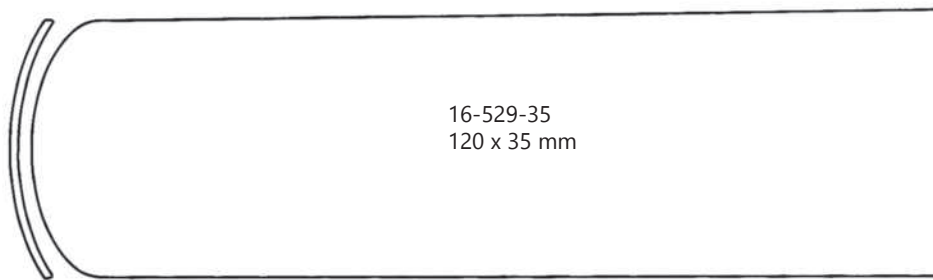

16-529-35
120 x 35 mm

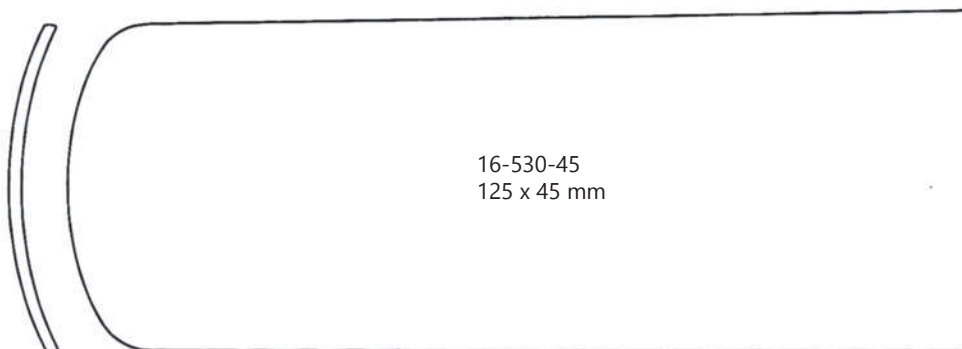

16-530-45
125 x 45 mm



ANDERSON-ADSON
16-532-20 20 cm sharp
16-533-20 20 cm blunt

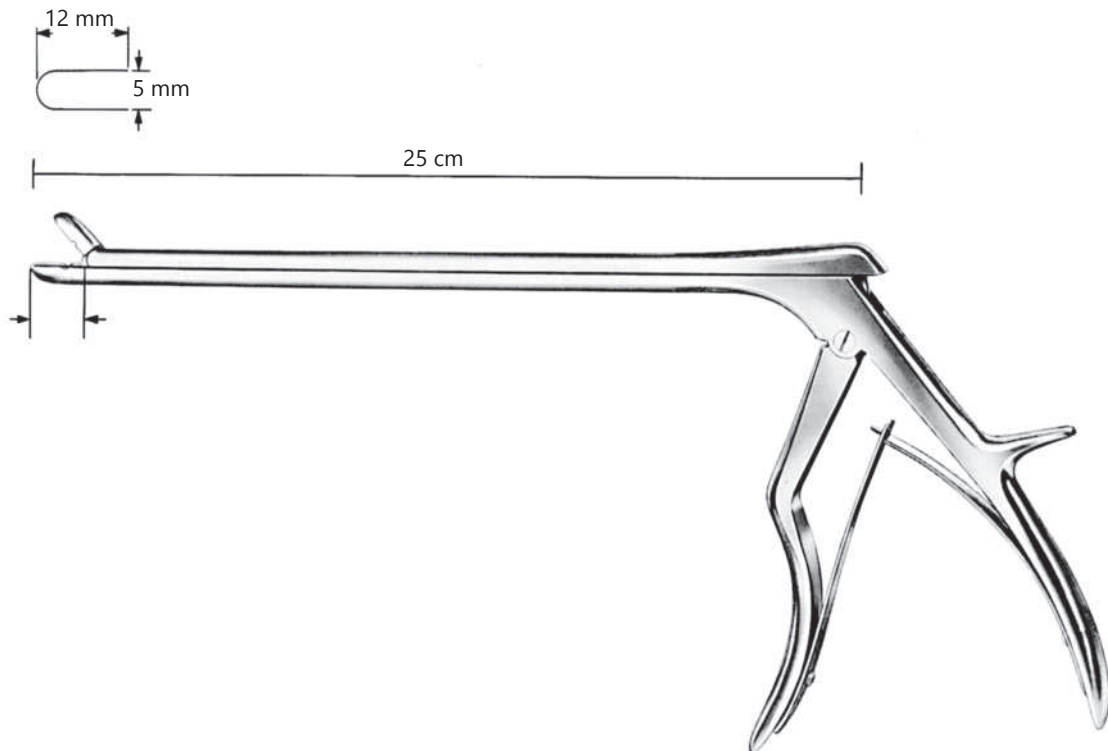

BEAUJEAN-ROOS
16-535-25



17

Anaesthesia
Narkose
Anestesia

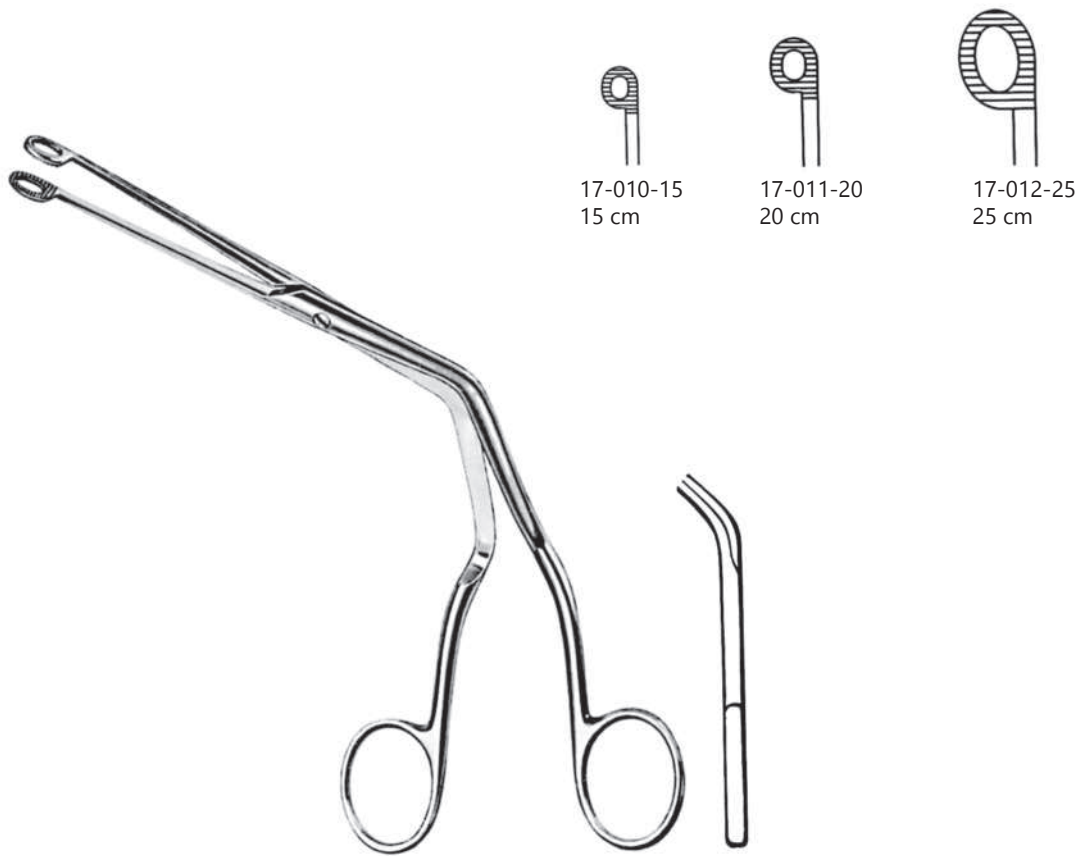

MAGILL
17-010-15 - 17-012-25

GUEDEL - NEGUS
Laryngo Scope Set Consisting of :

- 17-014-00
- 17-015-00 70 mm
- 17-016-01 90 mm
- 17-017-02 110 mm
- 17-018-03 135 mm



17-015-00
70 mm



17-016-01
90 mm



17-017-02
110 mm



17-018-03
135 mm



17-022-01
55 mm



17-023-02
80 mm



17-024-03
130 mm



17-025-04
170 mm



17-026-05
180 mm



17-020-00

MILLER
Laryngo Scope Set Consisting of :

- 17-014-00
- 17-022-01 55 mm
- 17-023-02 80 mm
- 17-024-03 130 mm
- 17-025-04 170 mm
- 17-026-05 180 mm



17-014-00
battery handle



SPAREBULB
17-032-00

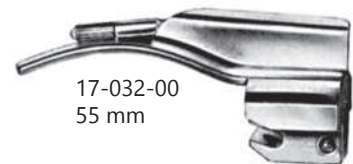

17-032-00
55 mm



17-033-01
75 mm



17-034-02
90 mm



17-035-03
110 mm



17-036-04
135 mm

MCINTOSH
Laryngo Scope Set Consisting of :

- 17-014-00
- 17-0150-01 55 mm
- 17-0154-02 75 mm
- 17-0158-03 90 mm
- 17-0162-04 110 mm
- 17-0166-05 135 mm



17-014-00
battery handle



18

Bone Surgery
Knochenchirurgie
Cirurgía ósea



MEAD
18-010-17
17 cm



18-012-01
26 mm Ø



18-013-02
28 mm Ø



18-014-03
30 mm Ø



WILLINGER
18-012-01 - 18-014-03



LEAD FILLED
18-016-16
16.5 cm



MINI-FRIEDMAN
18-018-12
12 cm



FRIEDMAN
18-020-14
14 cm



CLEVELAND
18-022-14
14 cm



CLEVELAND
18-024-17
17 cm

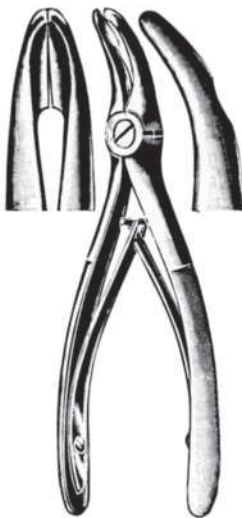

UNIVERSAL
18-026-13
13.5 cm



MEAD
18-028-16
16.5 cm



HARTMANN
18-030-18
18.5 cm



BLUMENTHAL
18-032-15
15.5 cm



BLUMENTHAL
18-034-15
15.5 cm



BLUMENTHAL
18-036-15
15.5 cm



LUER
18-038-15 - 18-039-15
15 cm



LUER
18-041-15
15 cm



BEYER
18-043-18
18 cm



BLUMENTHAL-S
18-045-00
15 cm



BLUMENTHAL
18-047-16
16.5 cm



HARTMANN
18-049-18
18 cm



BLUMENTHAL
18-051-16
16 cm



BLUMENTHAL
18-053-15
15 cm



BLUMENTHAL
18-055-15
15 cm



CLEVELAND 3
18-057-14
14 cm



CLEVELAND 4
18-059-15
15 cm



CLEVELAND 4A
18-061-17
17 cm



CLEVELAND 5
18-063-17
17 cm



CLEVELAND 5S
18-065-15
15 cm

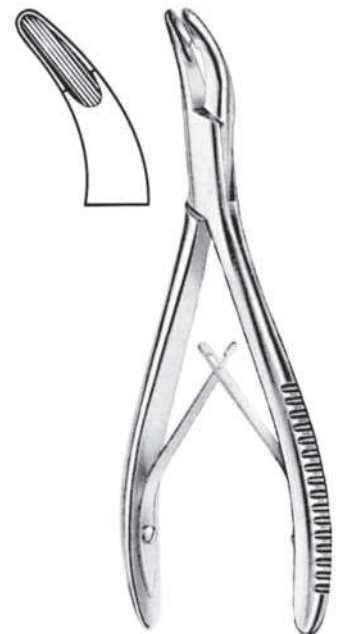

CLEVELAND 10
18-067-17
17 cm



18-069-00



18-071-13
13.5 cm



BANE
18-073-17
17 cm



JANSEN
18-075-00



JANSEN
18-077-00

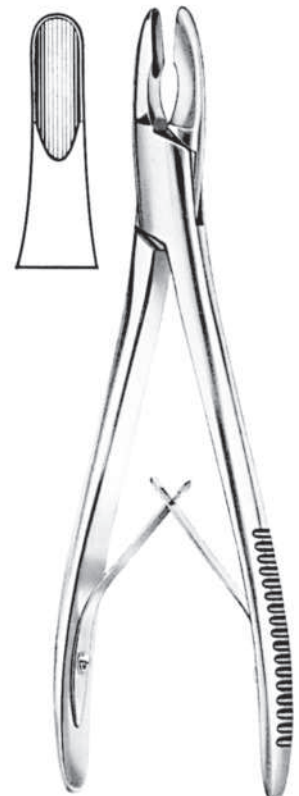

ADSON
18-079-20



CLEVELAND
 18-081-17
 17 cm

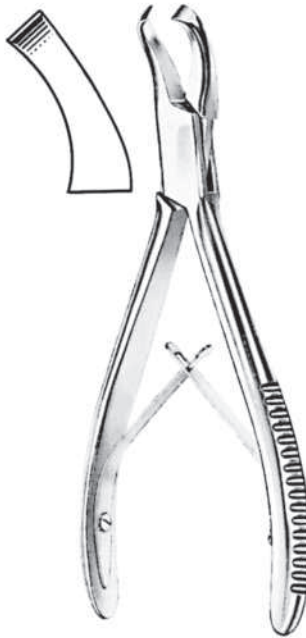

CLEVELAND-GARDNER
 18-083-17
 17 cm

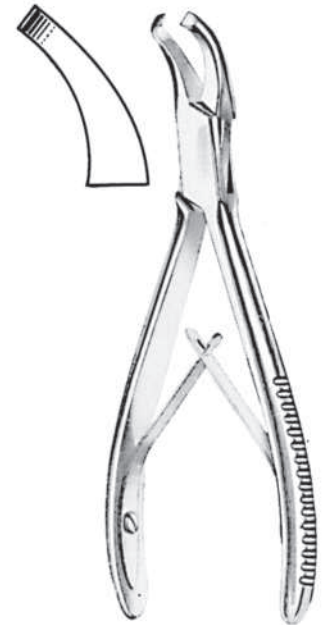

CLEVELAND-GARDNER
 18-085-16
 16 cm



18-087-17
 17.5 cm



18-089-14
 14 cm

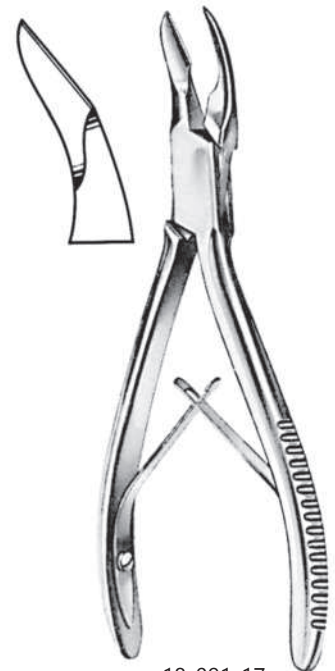

18-091-17
 17.5 cm

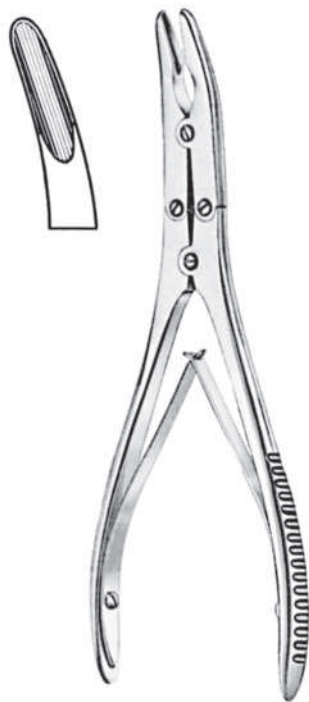

RUSKIN
18-093-18
18 cm

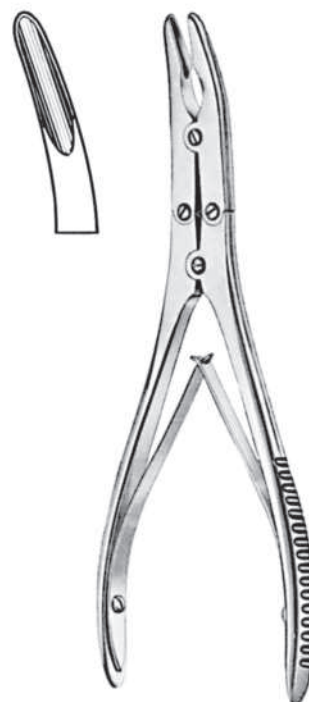

BEYER
18-095-18
18 cm



MAYFIELD
18-097-17
17 cm



ZAUFAL-JANSEN
18-099-18
18 cm



ECHLIN
18-101-02-103-04
23 cm

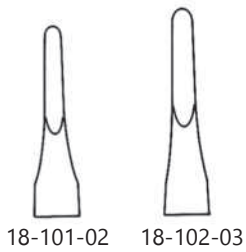

18-101-02 18-102-03

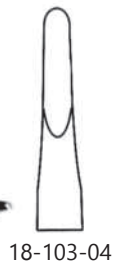

18-103-04



STILLE
18-105-23
23 cm



STILLE-LUER
18-107-22 - 18-109-22
23 cm

18-107-22

18-109-22

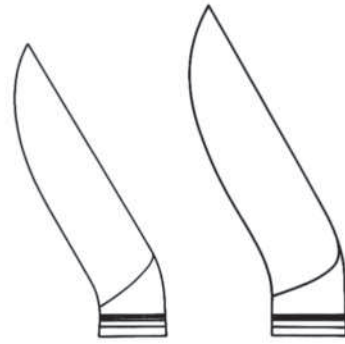

18-113-23
23 cm

18-114-27
27 cm



STILLE-LISTON
18-111-27
27 cm



STILLE-LISTON
18-113-23 - 18-114-27

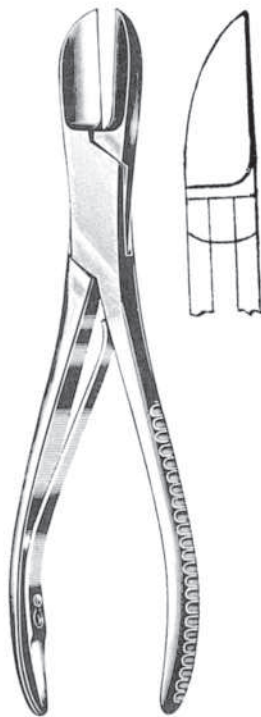

LISTON
18-116-14 - 18-119-22



18-116-14 14 cm



18-117-17 17 cm



18-118-19 19 cm
18-119-22 22 cm

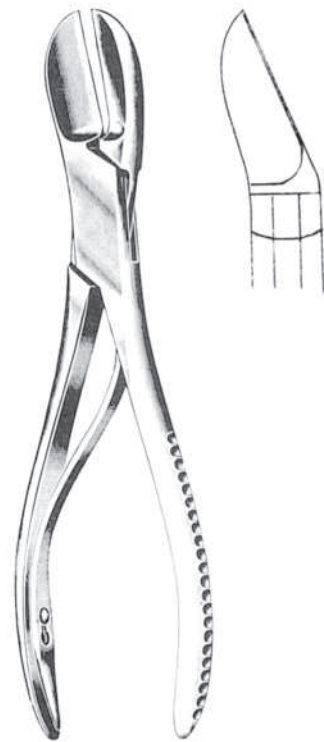

LISTON
18-121-14 14 cm
18-122-17 17 cm
18-123-19 19 cm
18-124-22 22 cm



LISTON-KEY-HORSLEY
18-126-26
26.5 cm

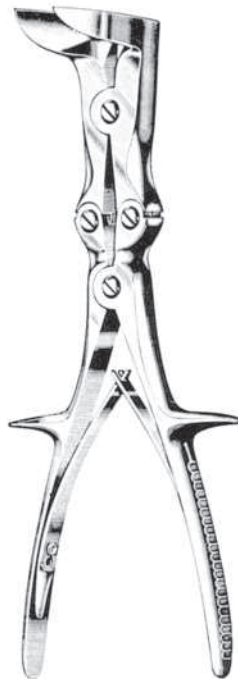

LISTON-STILLÉ
18-128-26
26 cm

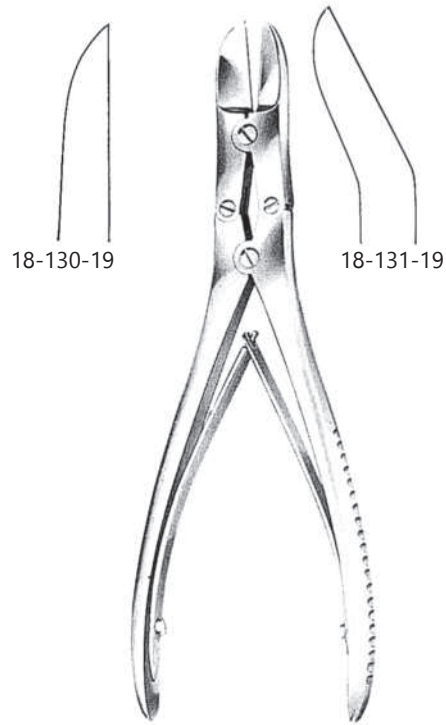

RUSKIN-LISTON
18-130-19 - 18-131-19

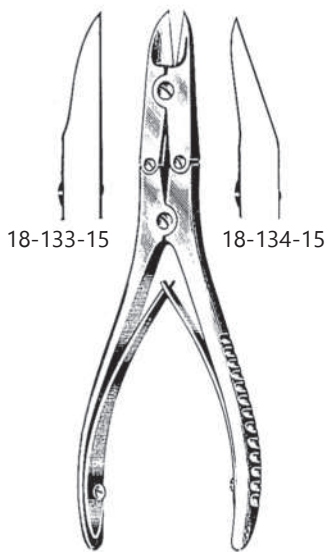

BOHLER
18-133-15 - 18-134-15

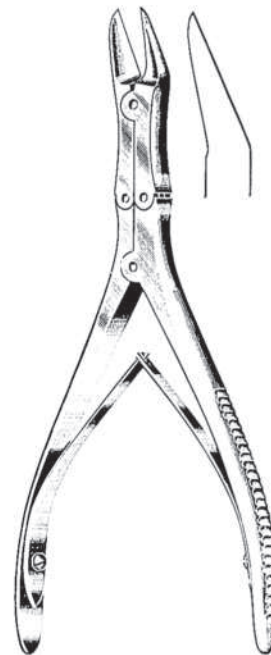

Mc INDOE
18-136-17
17 cm



18-138-13
13.5 cm



KERN
18-140-17 - 18-141-21

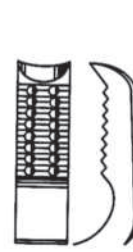

18-140-17
17 cm

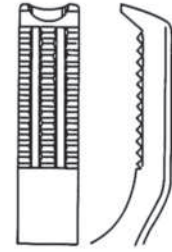

18-141-21
21 cm



18-143-16 - 18-144-24

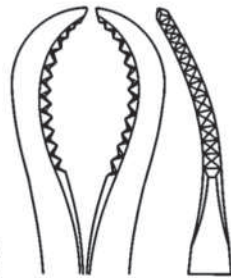

18-143-16
16 cm

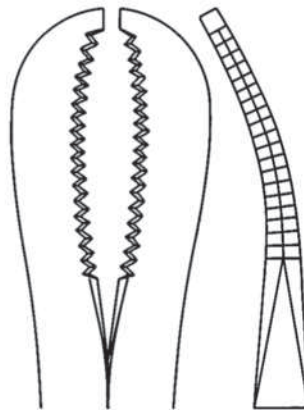

18-144-24
24 cm



18-146-14
13.5 cm



LAMBOTTE
18-148-22 22 cm
18-149-27 27 cm
18-150-30 30 cm



ULRICH
18-152-23 23 cm
18-153-25 25 cm
18-154-28 28 cm



18-156-16
16 cm



18-158-17 - 18-159-17
17 cm



18-158-17



18-159-17



18-160-19
19 cm



18-162-22
22 cm

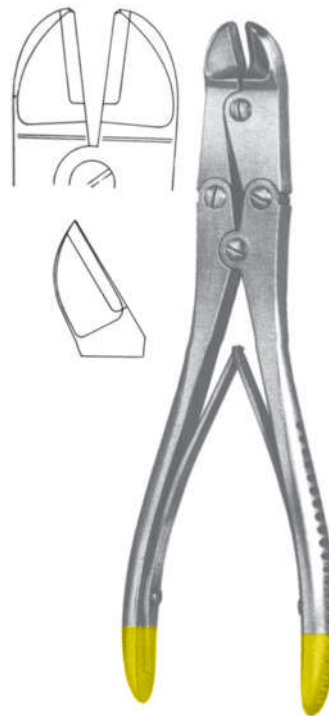

18-164-17
17.5 cm



18-166-47
47 cm



18-168-22
22 cm

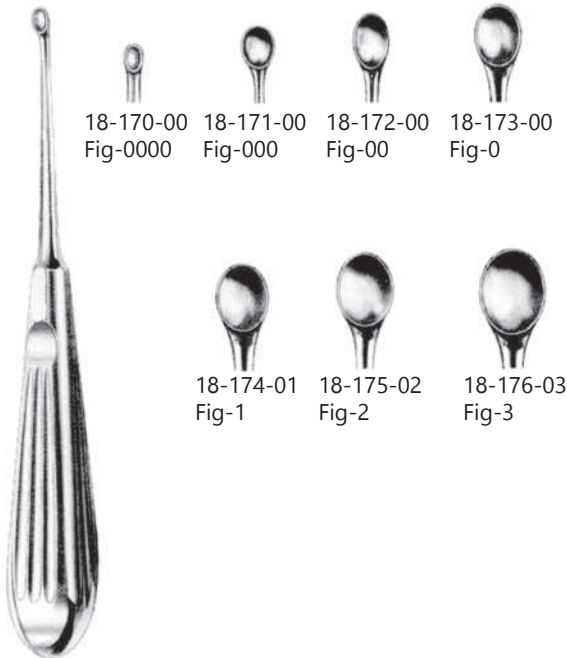

18-170-00 Fig-0000
18-171-00 Fig-000
18-172-00 Fig-00
18-173-00 Fig-0

18-174-01 Fig-1
18-175-02 Fig-2
18-176-03 Fig-3

VOLKLANN
18-170-00 - 18-176-03
17 cm

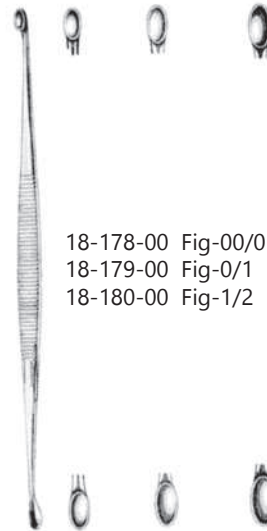

18-178-00 Fig-00/0
18-179-00 Fig-0/1
18-180-00 Fig-1/2

WILLIGER
18-178-00 - 18-180-00
14 cm

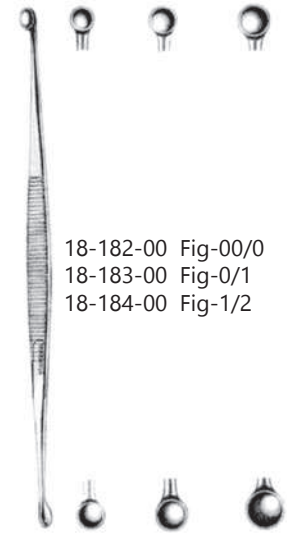

18-182-00 Fig-00/0
18-183-00 Fig-0/1
18-184-00 Fig-1/2

MARTINI
18-182-00 - 18-184-00
14 cm

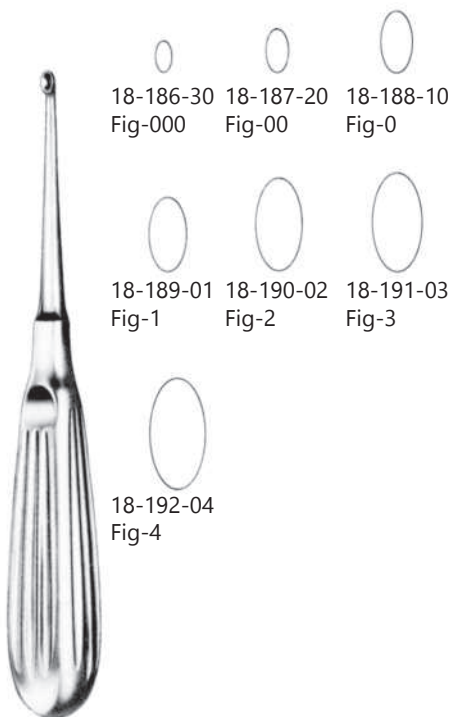

18-186-30 Fig-000
18-187-20 Fig-00
18-188-10 Fig-0

18-189-01 Fig-1
18-190-02 Fig-2
18-191-03 Fig-3

18-192-04 Fig-4

SCHEDE
18-186-30 - 18-192-04

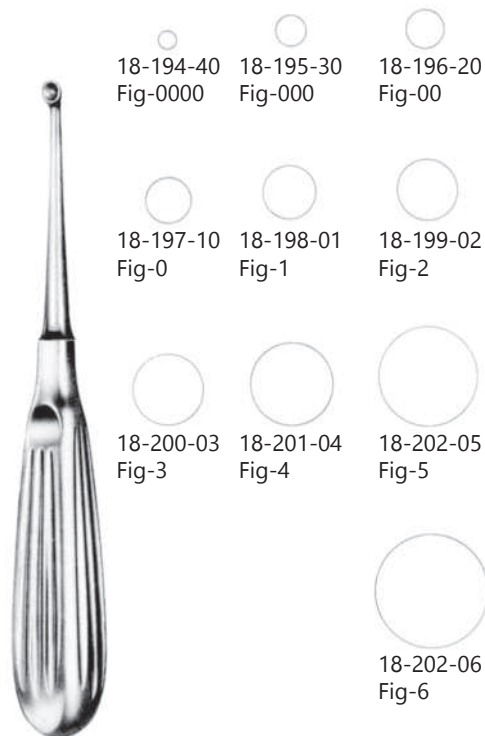

18-194-40 Fig-0000
18-195-30 Fig-000
18-196-20 Fig-00

18-197-10 Fig-0
18-198-01 Fig-1
18-199-02 Fig-2

18-200-03 Fig-3
18-201-04 Fig-4
18-202-05 Fig-5

18-202-06 Fig-6

BRUNS
18-194-40 - 18-203-06

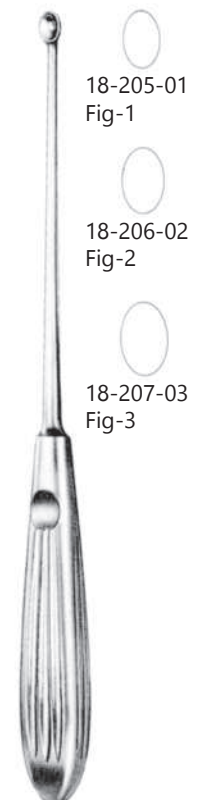

18-205-01 Fig-1

18-206-02 Fig-2

18-207-03 Fig-3

HALLE
18-205-01 - 18-207-03

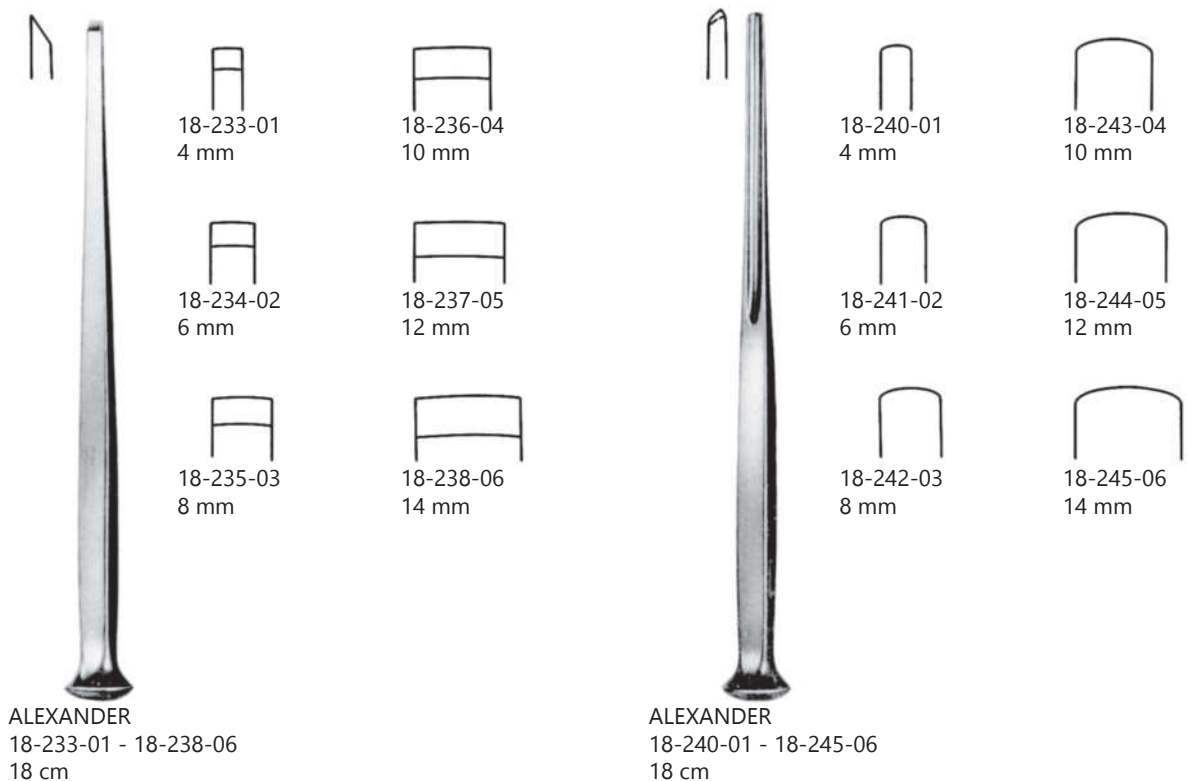
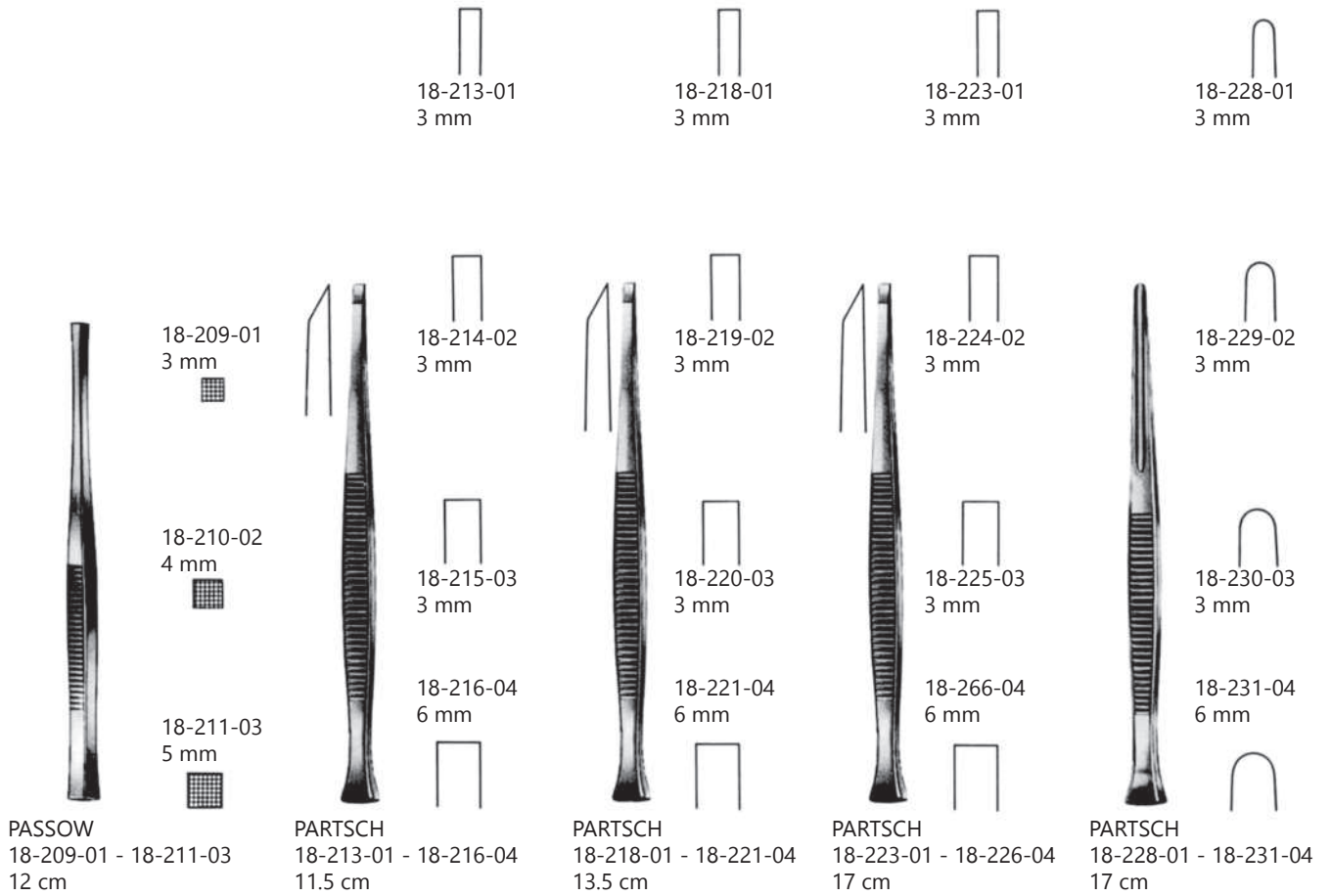

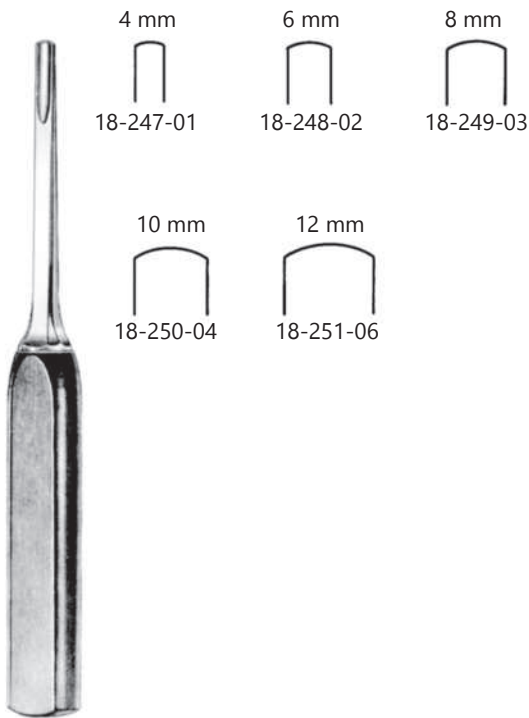

MINI-LEXER
18-247-01 - 18-251-05
18 cm

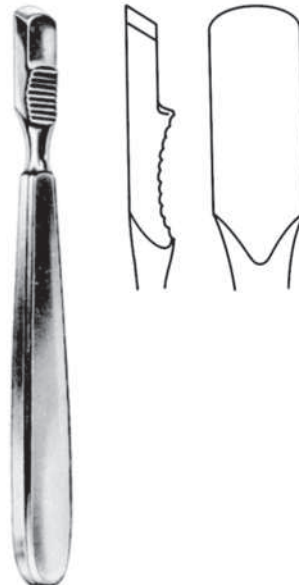

FARABEUF
18-253-15
15 cm

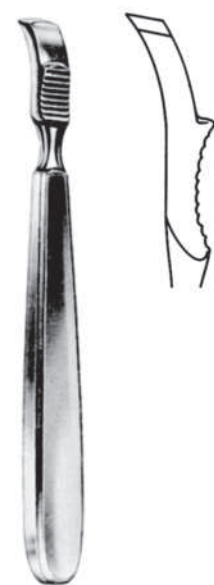

FARABEUF
18-255-15
15 cm

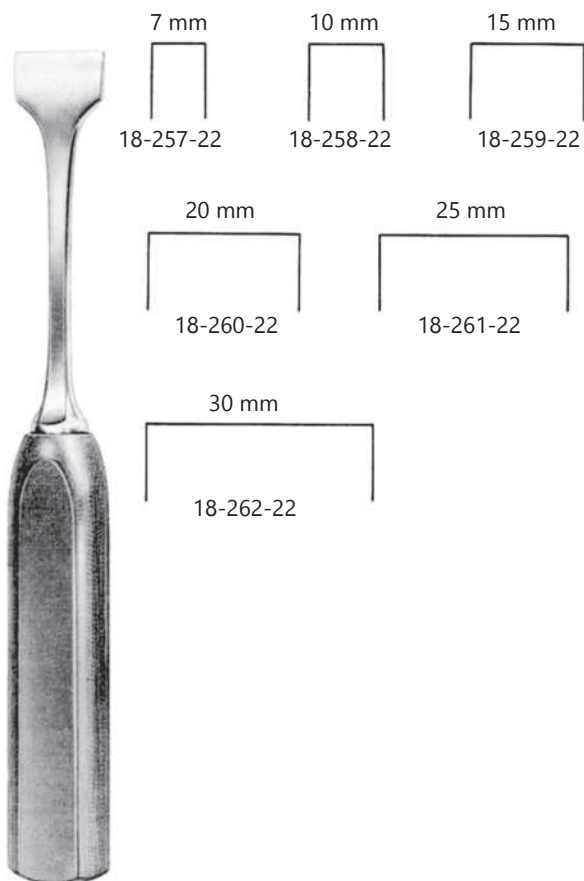

LEXER
18-257-22 - 18-262-22
22 cm

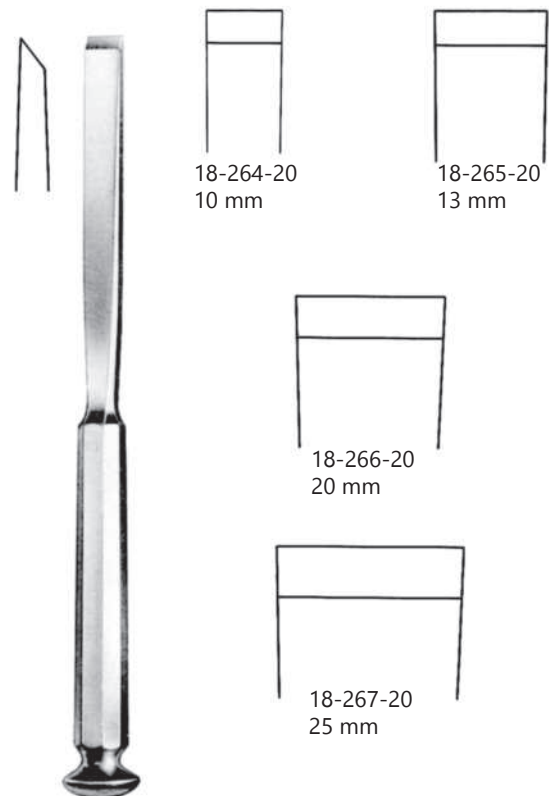

STILLE
18-264-20 - 18-267-20
20 cm

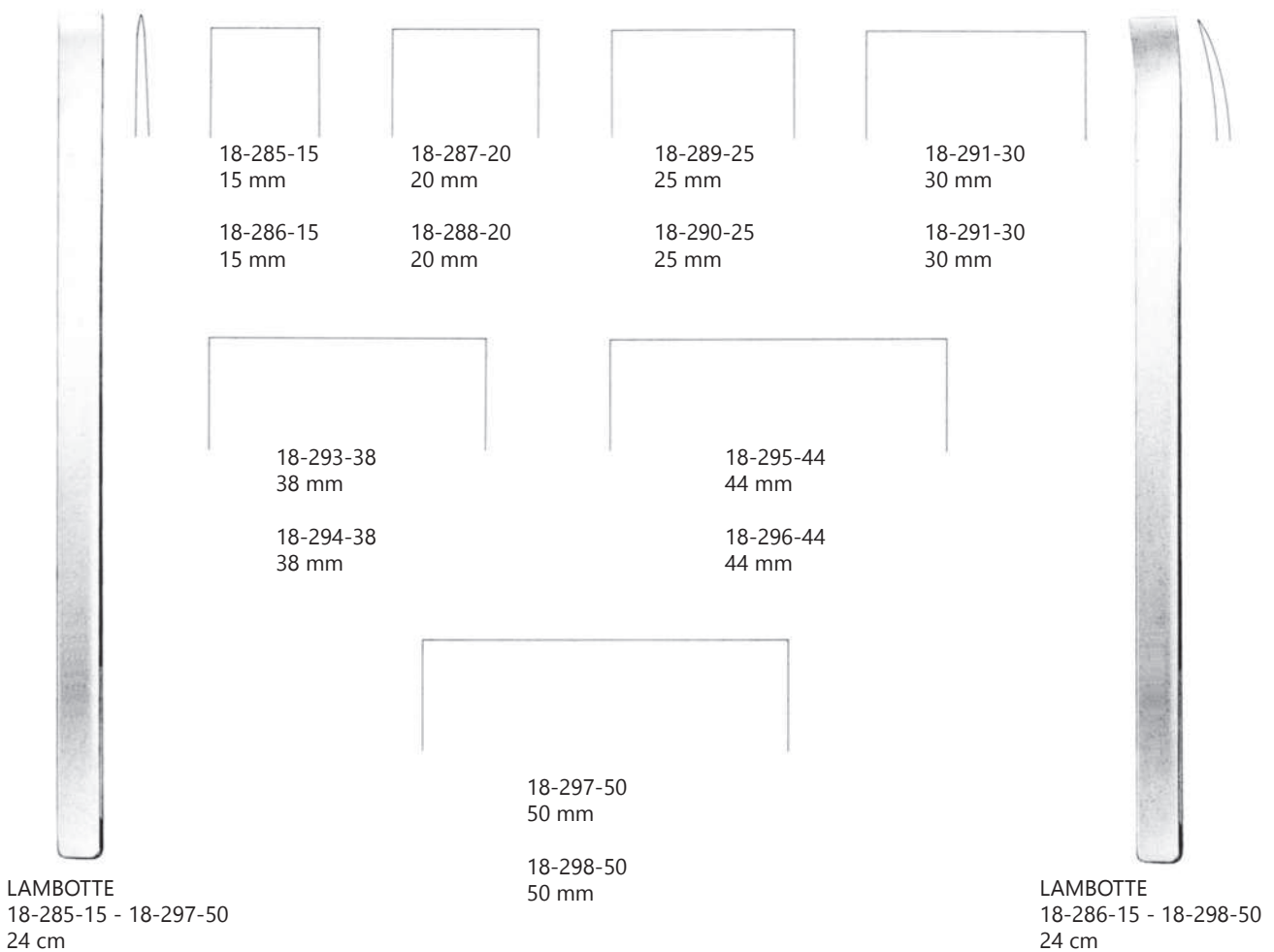
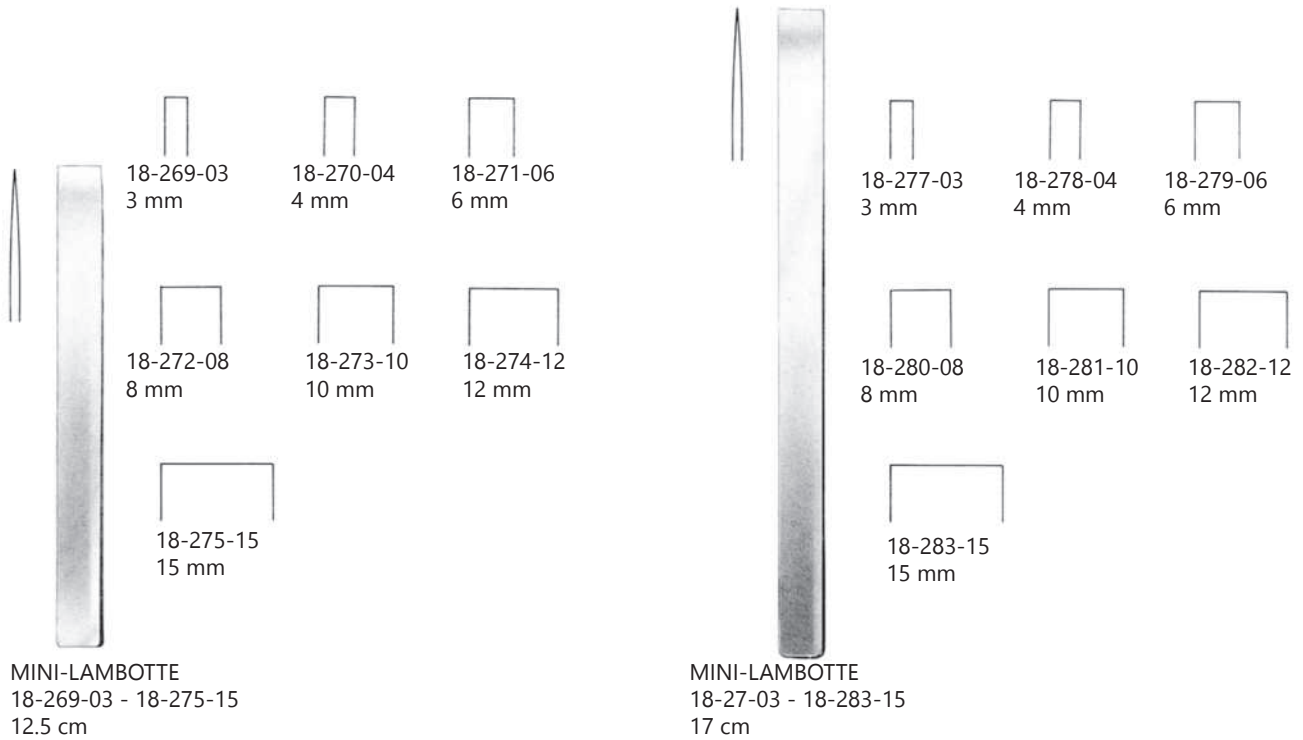

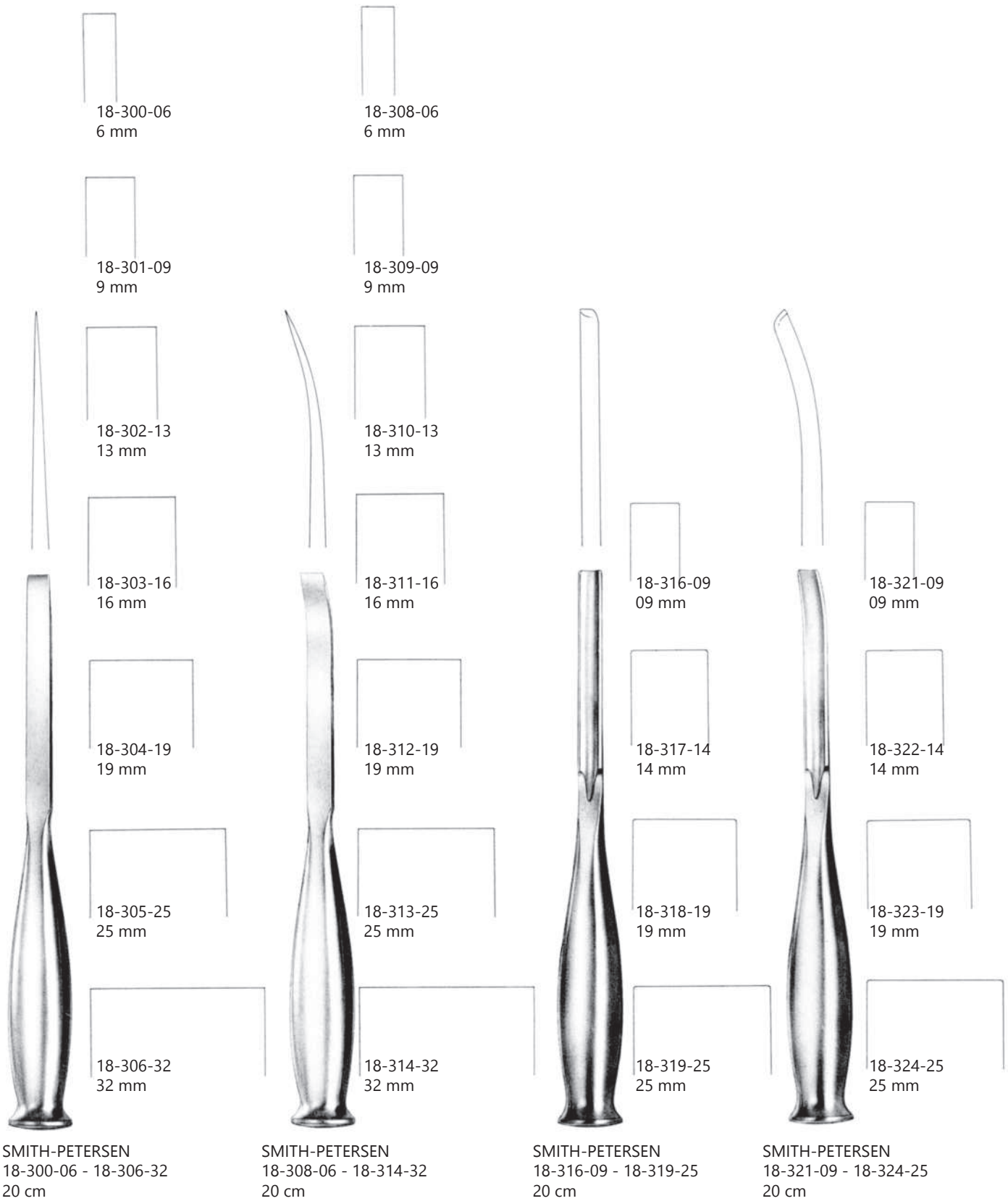



Mini - Lexer
18 cm
18-326-04 4 mm
18-327-06 6 mm
18-328-08 8 mm
18-329-10 10 mm
18-330-12 12 mm
18-331-15 15 mm



Mini - Lexer
22 cm
18-323-05 5 mm
18-334-07 7 mm
18-335-10 10 mm
18-336-15 15 mm
18-337-20 20 mm
18-338-25 25 mm
18-339-30 3 mm



Osteotom
20 cm

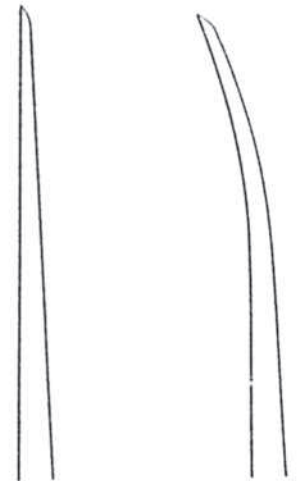

18-341-10	10 mm	18-345-10	10 mm
18-342-15	15 mm	18-346-15	15 mm
18-343-20	20 mm	18-347-20	20 mm



Mini - Lexer
18 cm
18-349-04 4 mm
18-350-06 6 mm
18-351-08 8 mm
18-352-10 10 mm
18-353-12 12 mm
18-354-15 15 mm



Mini - Lexer
18 cm
18-356-04 4 mm
18-357-06 6 mm
18-358-08 8 mm
18-359-10 10 mm
18-360-12 12 mm
18-361-15 15 mm



27 cm



Fig-00
18-363-44
Fig-1
18-364-68
Fig-2
18-365-85
Fig-3
18-366-10



27 cm

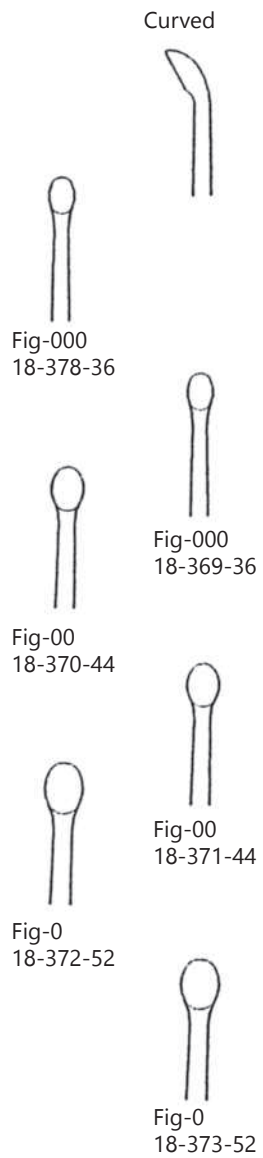

Curved
Fig-000
18-378-36
Fig-000
18-369-36
Fig-00
18-370-44
Fig-00
18-371-44
Fig-0
18-372-52
Fig-0
18-373-52



LAMBOTTE
18-375-10 - 18-378-25
21 mm

18-375-10
10 mm
18-376-15
15 mm
18-377-20
20 mm
18-378-25
25 mm



SEMB
 18-380-01 - 18-384-04



18-380-01
 18.5 mm



18-381-02
 23 mm



18-382-03
 18.5 mm



18-383-04
 18.5 mm



18-384-05
 21.5 mm

5 mm



WILLIGER
 18-386-16
 16.5 cm

5.5 mm



WILLIGER
 18-388-17
 17.5 cm

4 mm



WILLIGER
 18-390-14
 14 cm

6.5 mm



WILLIGER
 18-392-16
 16 cm



19

Dressing
Verband, Gips
Vendajes



STILLE-MOD
19-010-23 - 19-011-37

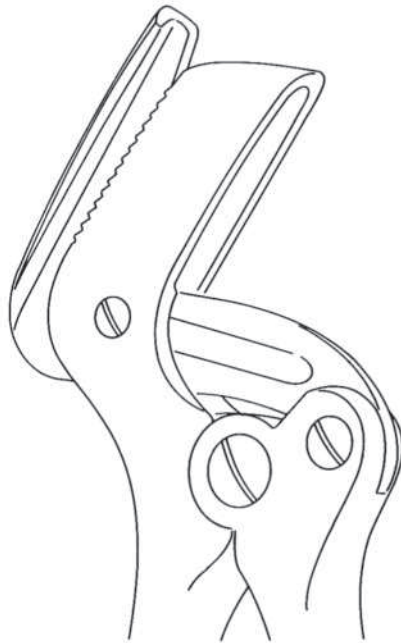

19-010-23
23 cm

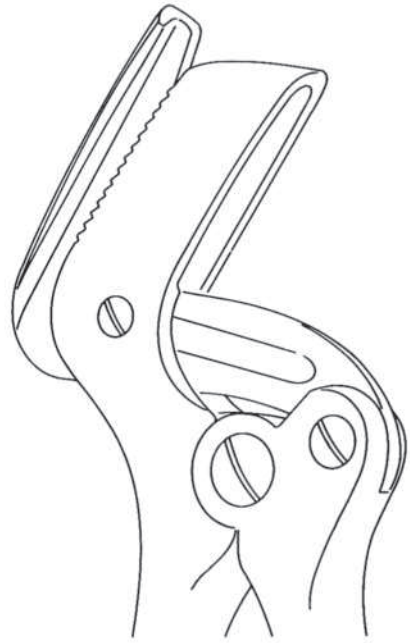

19-011-26
26 cm

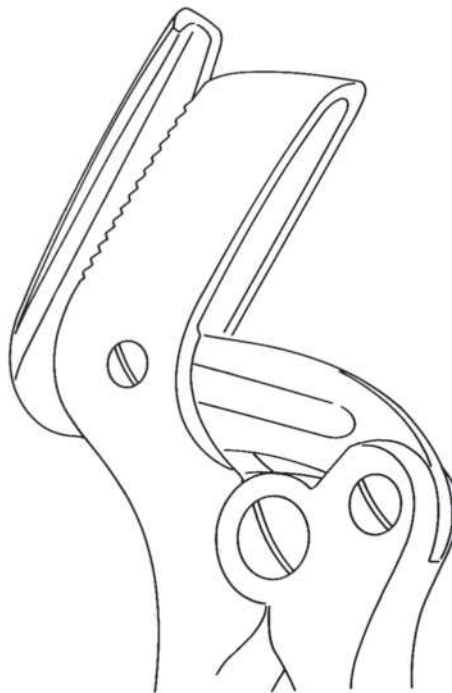

19-013-37
37 cm

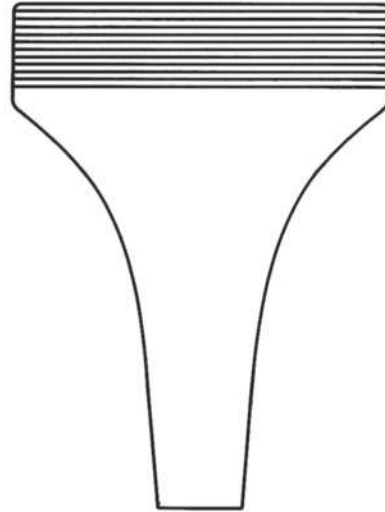

HENNING
 19-015-28
 28 cm



19-017-18
 18 cm



19-018-24
 24 cm

WOLF
 19-017-18 - 19-018-24

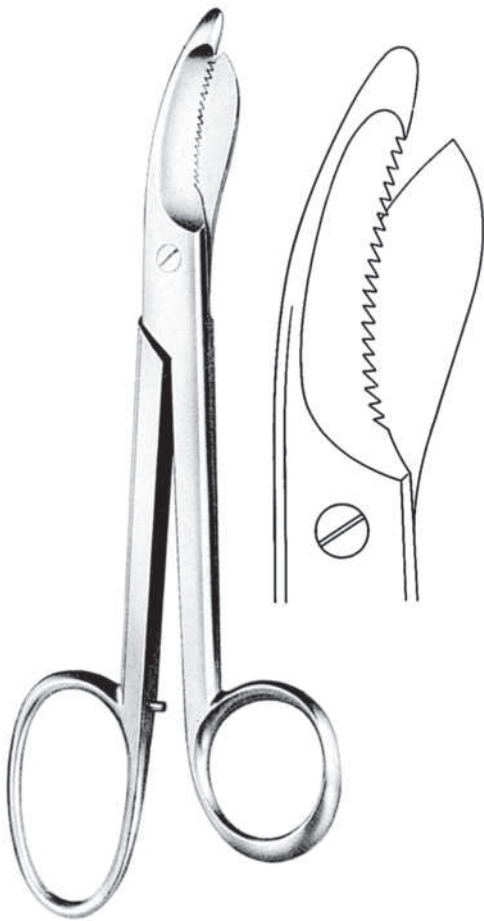

BRUNS
19-020-24
24 cm

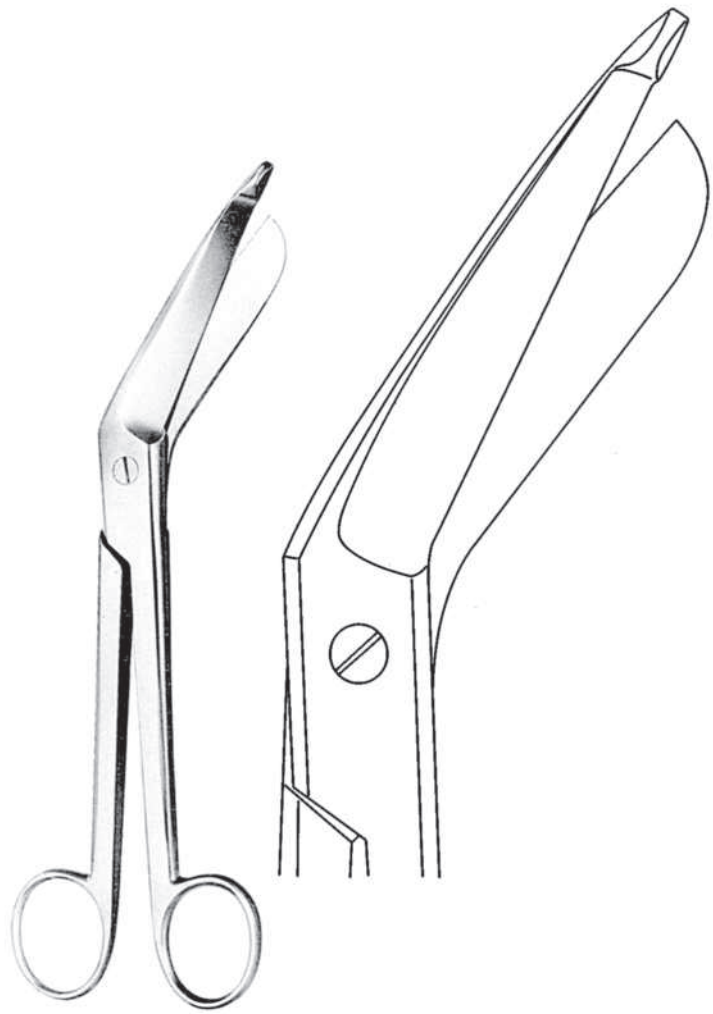

BERGMANN
19-023-23
23 cm

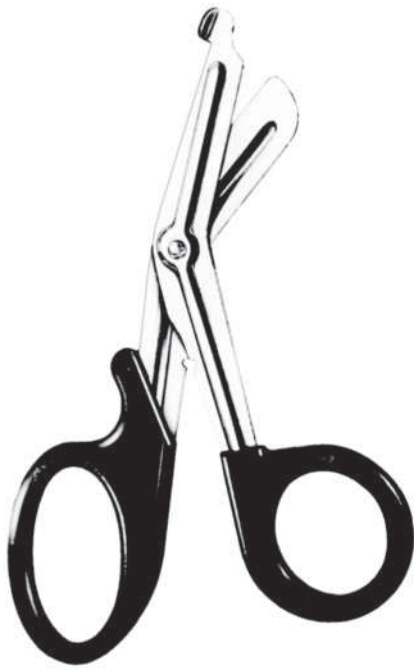

LISTER (UNIVERSAL)
19-024-15 15 cm
19-025-18 18 cm
(handle available in differant colours)



LISTER (ROUND TYPE)
19-027-18 18 cm
19-028-20 20 cm

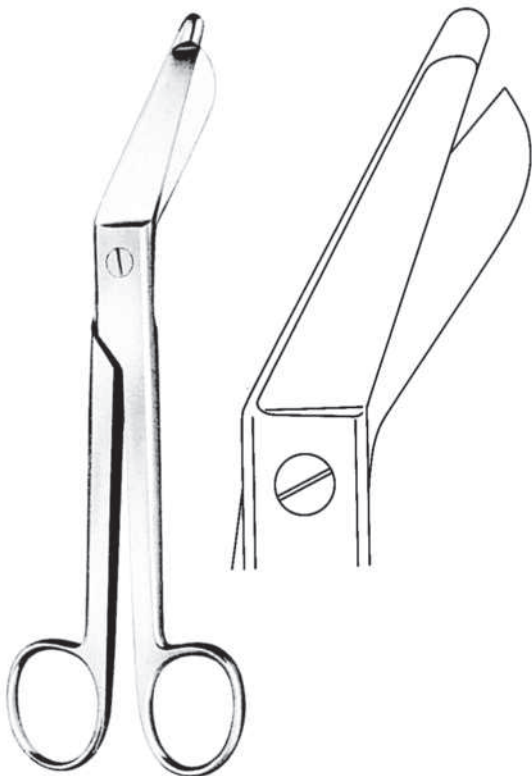

ESMARCH
19-030-20
20 cm

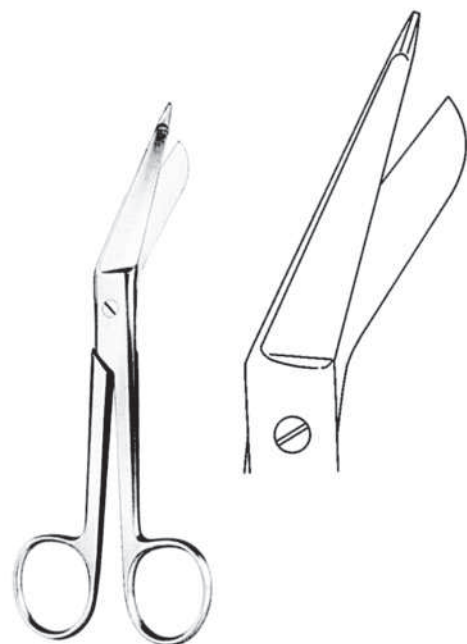

LISTER
19-032-14 14 cm
19-033-18 18 cm
19-034-20 20 cm

TC GOLD

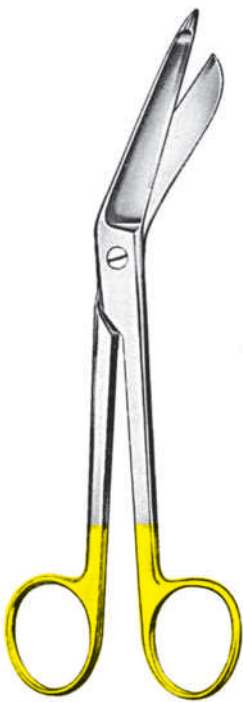

LISTER
19-036-18
18 cm

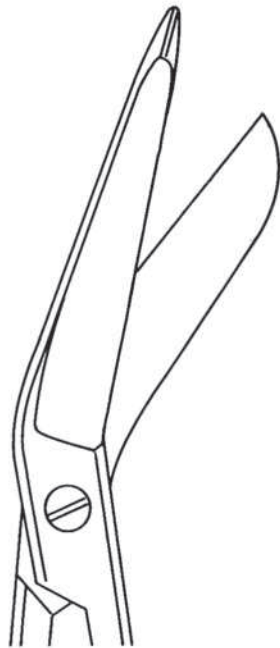

BRUNS
19-038-24
24 cm

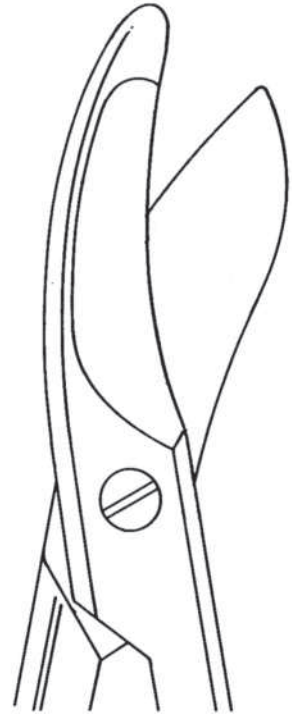

LISTER (ROUND TYPE)
19-040-18 18 cm
19-041-20 20 cm



20

Intestines, Stomach, Rectum
Darm, Magen, Masdarm
Intestinos, Estómago, Recto

4 : 5 teeth
20-010-15 15 cm

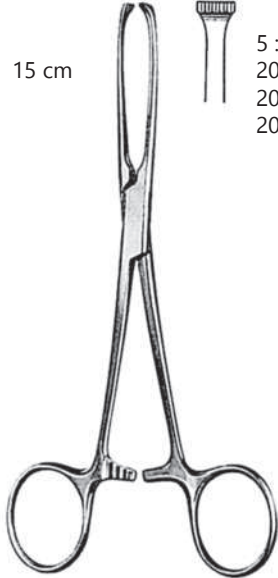

ALLIS
20-010-15 - 20-013-25

5 : 6 teeth
20-011-15 15 cm
20-012-19 19 cm
20-013-25 25 cm



ALLIS-BABY
20-015-12
12 cm
4 : 5 teeth

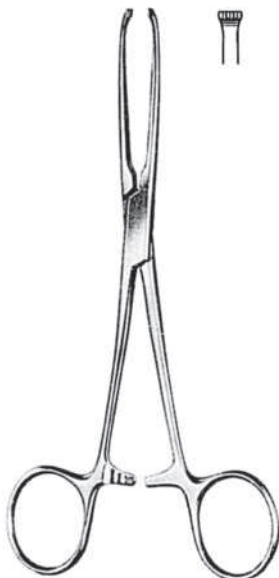

JUDD-ALLIS
20-017-15 15 cm
20-018-19 19 cm



ALLIS-BABY
20-020-15
15 cm





BABCOCL
 20-022-16 - 20-025-24



20-022-16
 16 cm



20-023-18
 18 cm



20-024-20
 20 cm

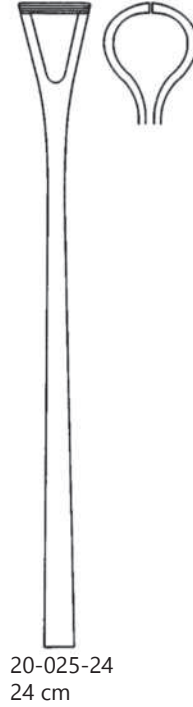

20-025-24
 24 cm

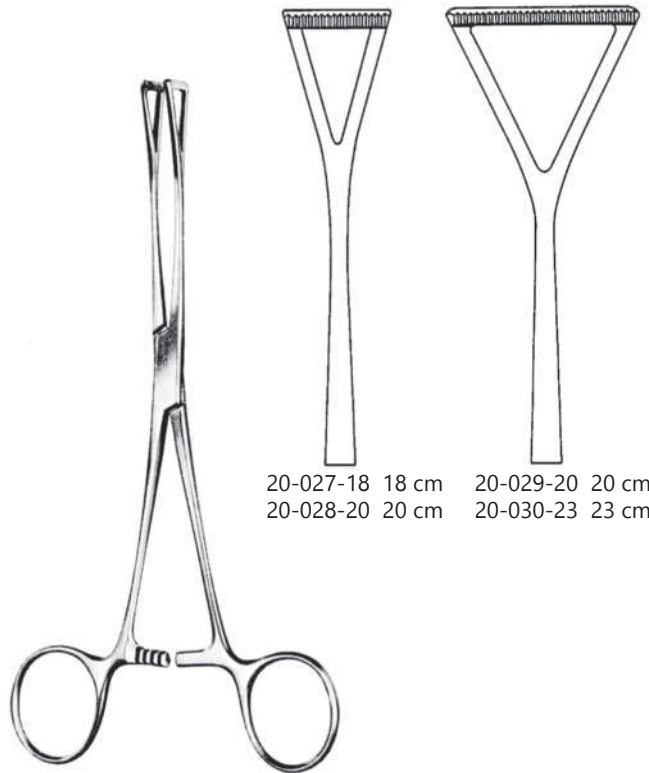

DUVAL
 20-027-18 - 20-030-23



20-027-18 18 cm
 20-028-20 20 cm

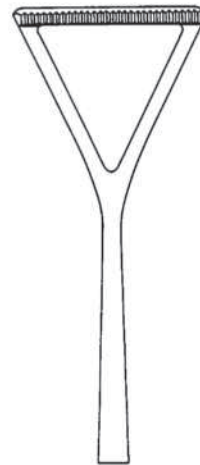

20-029-20 20 cm
 20-030-23 23 cm

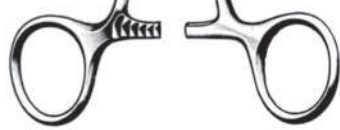
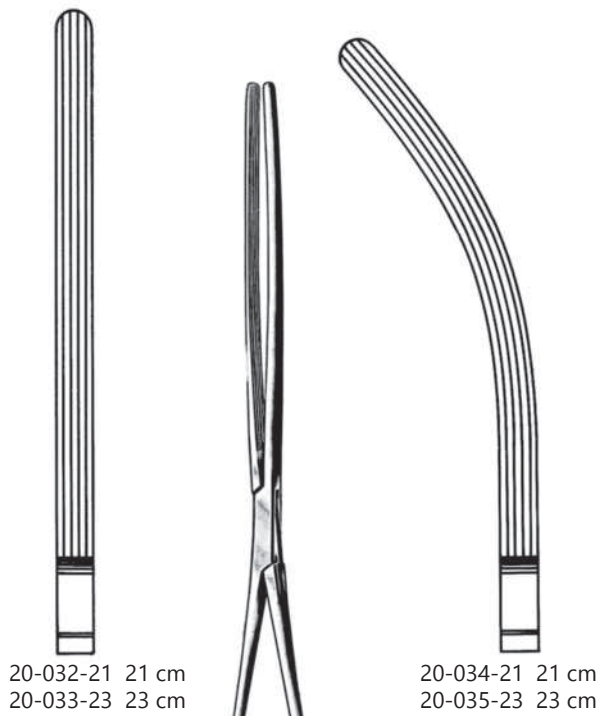

MAYO-ROBSON
20-032-21 - 20-035-23

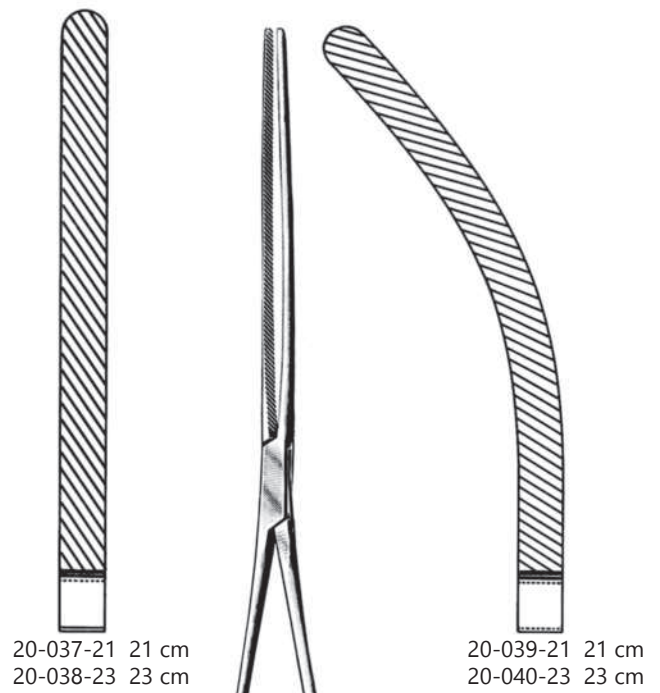

DOYEN
20-037-21 - 20-040-23

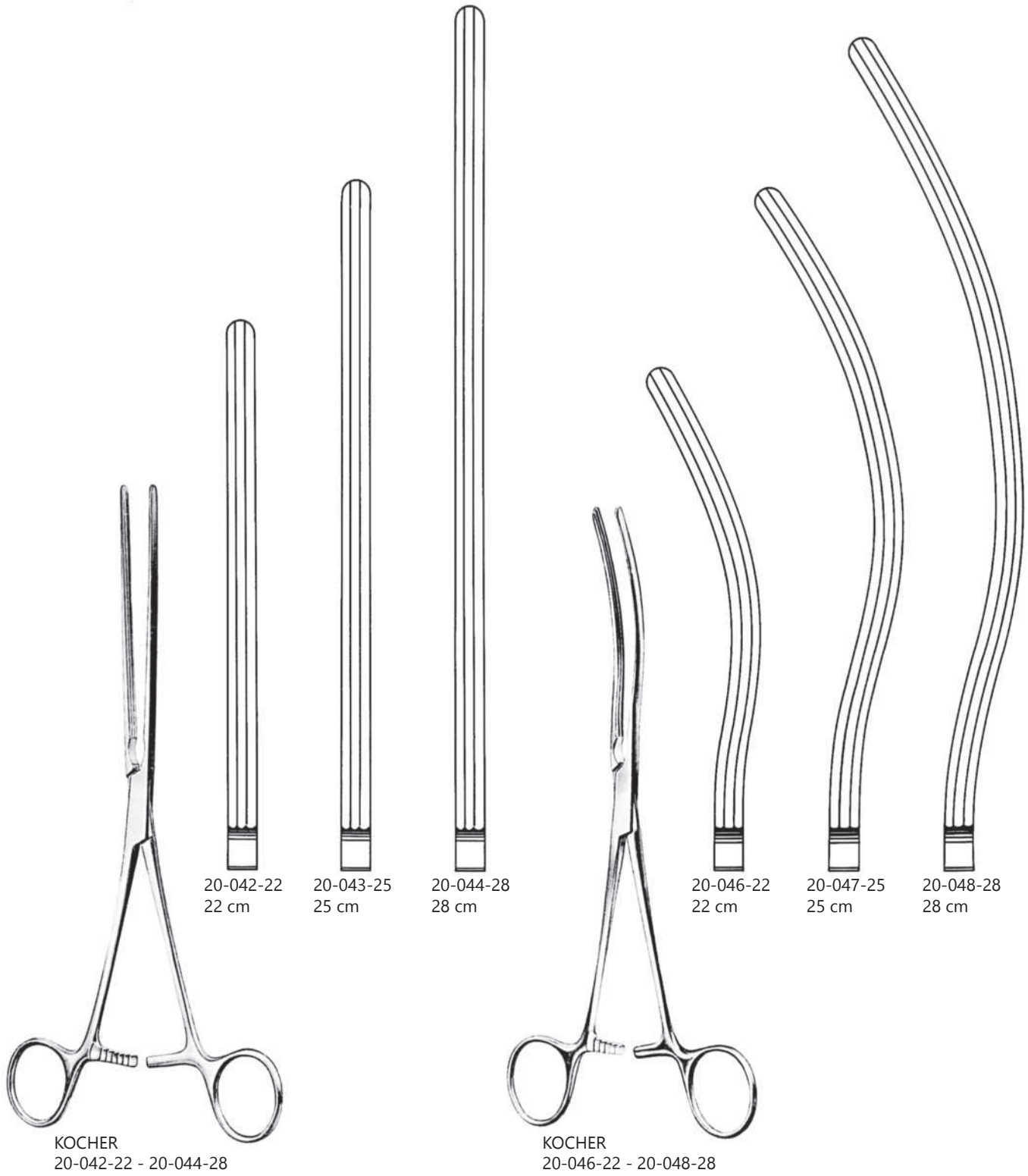

20-042-22
22 cm

20-043-25
25 cm

20-044-28
28 cm

20-046-22
22 cm

20-047-25
25 cm

20-048-28
28 cm

KOCHER
20-042-22 - 20-044-28

KOCHER
20-046-22 - 20-048-28

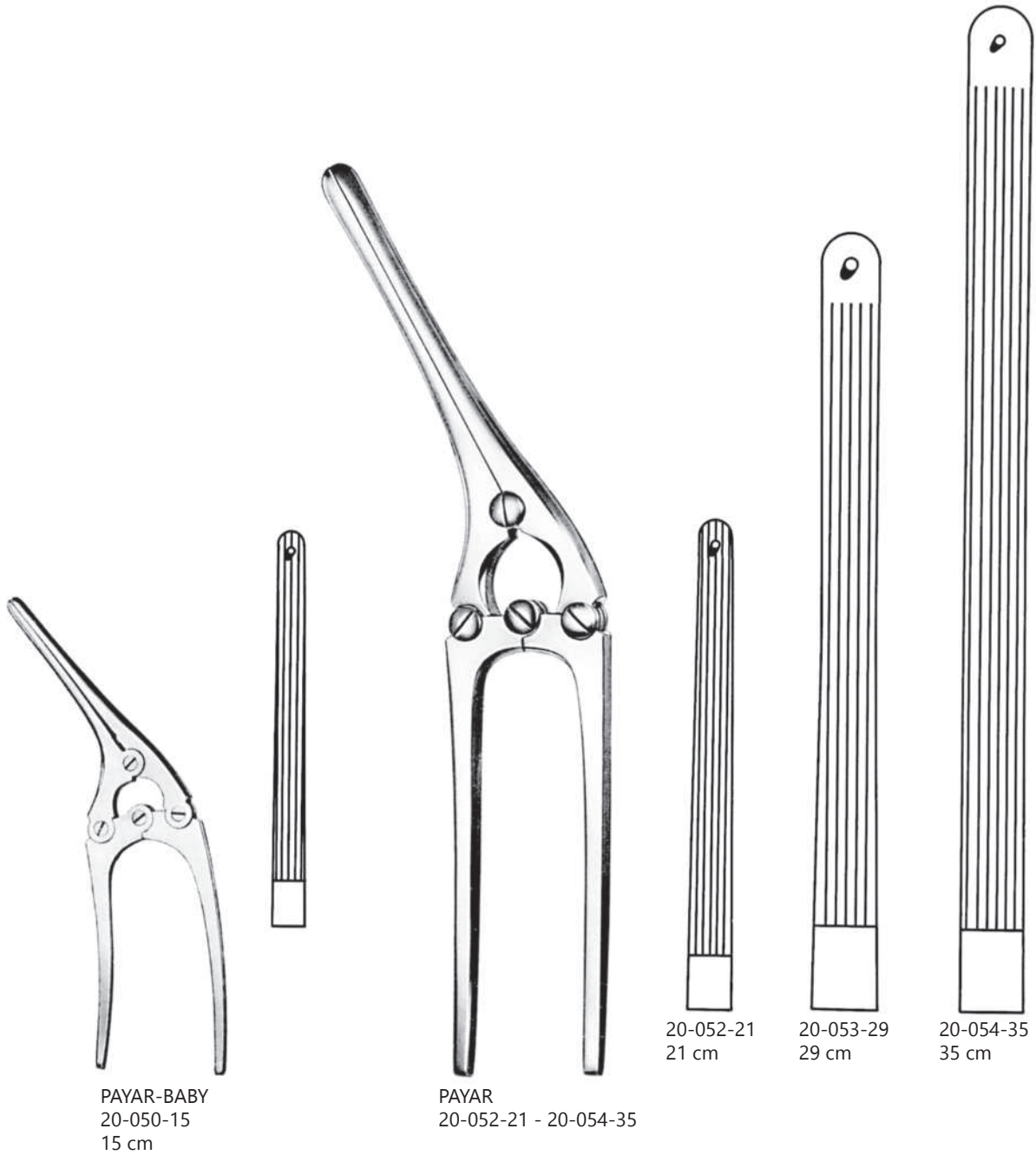

21

Neurosurgery and Laminectomy
Neurochirurgie und Laminektomie
Neurocirugía y Laminectomía



21-010-18 - 21-013-18
18 cm



21-010-18
25°



21-011-18
45°



21-012-18
60°



21-013-18
90°



21-015-18 - 21-018-18
18 cm



21-015-18
25°



21-016-18
45°



21-017-18
60°



21-018-18
90°



MARKHAM-MEYERDING
21-020-18
18 cm

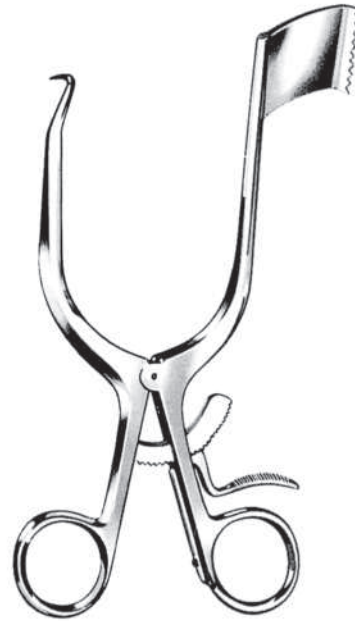

MARKHAM-MEYERDING
21-022-18
18 cm

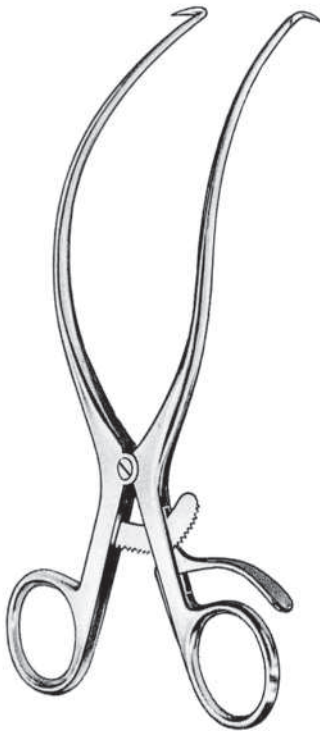

GELPI
21-024-09 9 cm
21-025-11 11 cm
21-026-14 14 cm
21-027-19 19 cm



JANSEN
MARKHAM-MEYERDING
21-029-10 10 cm sharp
21-030-10 10 cm blunt

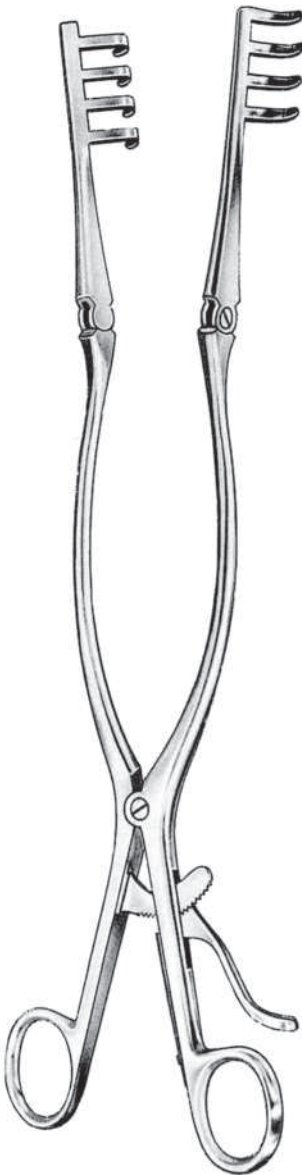

BECKMANN

21-041-31	31 cm	21-043-31	31 cm	4x4 teeth
21-042-33	33 cm	21-044-33	33 cm	4x5 teeth
Sharp		Blunt		



CONE

21-032-13	13 cm	21-036-13	13 cm
21-033-16	16.5 cm	21-037-16	16.5 cm
21-034-20	20 cm	21-038-20	20 cm
21-035-25	25 cm	21-039-25	25 cm
Sharp		Blunt	



BECKMANN-ADSON

21-046-31	31 cm	21-050-31	31 cm	25 x 25 mm
21-047-31	31 cm	21-051-31	31 cm	25 x 30 mm
21-048-31	31 cm	21-052-31	31 cm	25 x 40 mm
21-049-31	31 cm	21-053-31	31 cm	25 x 45 mm
Sharp		Blunt		



ADSON
21-055-27
27 cm



ADSON
21-059-27
27 cm

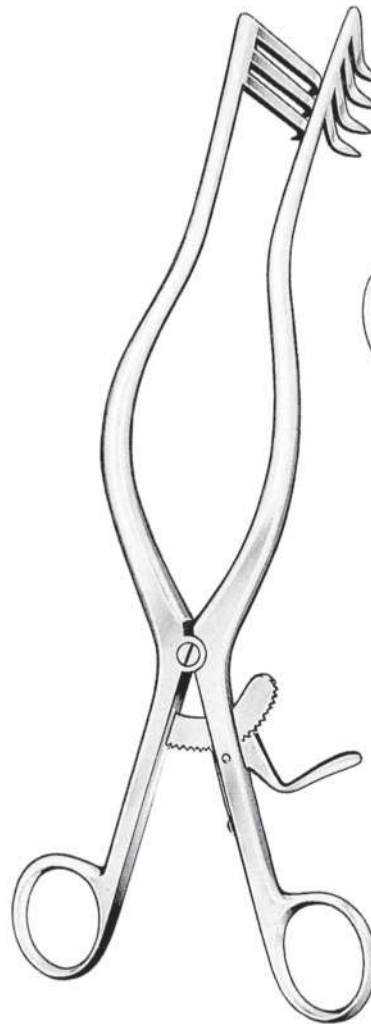

ADSON
21-061-27 27 cm sharp
21-062-27 27 cm blunt

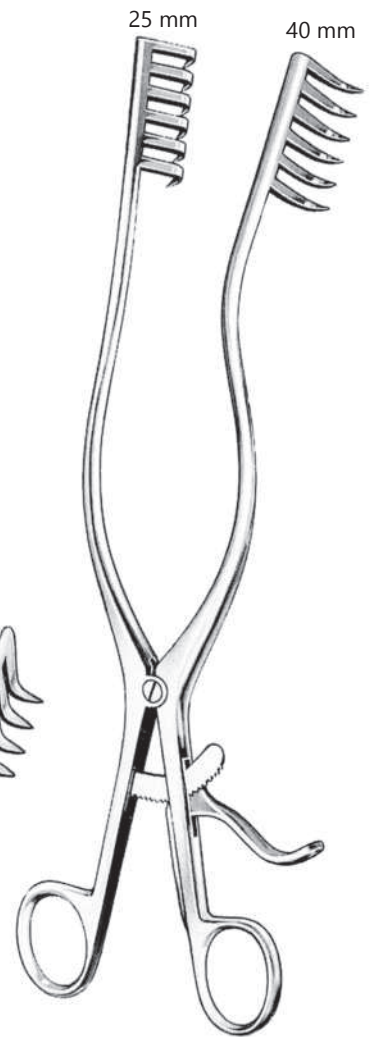

ADSON
21-057-27
27 cm



MAYFIELD
21-064-17
17 cm



ZAUFAL-JANSEN
21-066-18
18 cm

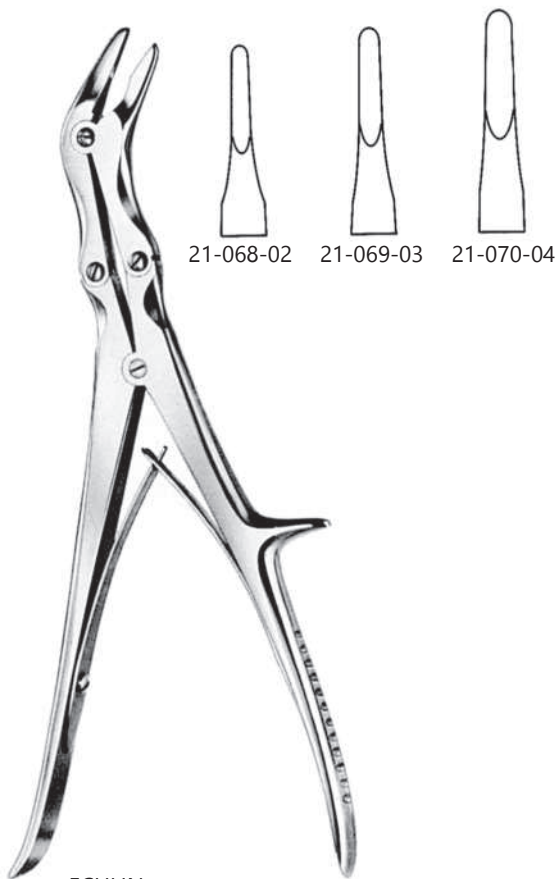

ECHLIN
21-068-02 - 21-070-04
23 cm



STILLE
21-072-23
23 cm

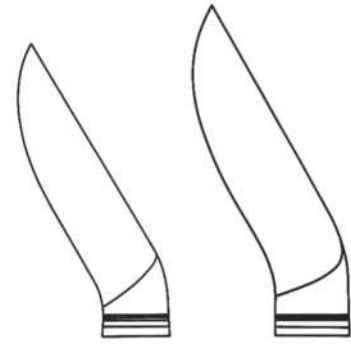

21-079-23
23 cm

21-080-27
27 cm

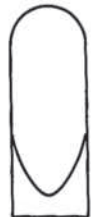

21-074-22



21-075-22



STILLE-LUER
21-074-22 - 21-075-22
22 cm



STILLE-LISTON
21-077-27
27 cm



STILLE-LISTON
21-079-23 - 21-080-27



HOEN
21-082-02
15 cm



HOEN
21-084-03
15 cm



FRAZIER
21-086-01
15 cm

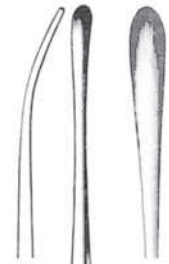

DAVIS
21-088-24
24.5 cm





PENFIELD
21-090-01
17.5 cm



PENFIELD
21-092-02
19.5 cm



PENFIELD
21-094-03
19.5 cm



PENFIELD
21-096-04
21.5 cm



PENFIELD
21-098-05
29 cm



TOENNIS
21-100-25
25 cm



DLIVECRONA
21-102-18 18 cm
21-103-24 24 cm



DLIVECRONA
21-105-19 19.5 cm
21-106-24 24 cm

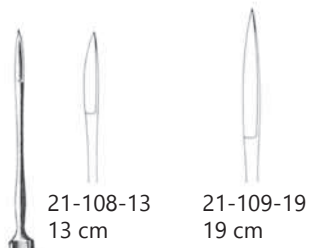

TOENNIS
21-108-13 - 21-109-19



TOENNIS
21-111-15
15 cm



HALLE
21-113-20
20 cm



ADSON
21-115-20
20 cm



GRAHAM
21-117-16
16.5 cm



SACHS
21-119-18
18.5 cm



21-121-19

21-122-19

21-123-19

LOVE
 21-121-19 - 21-123-19
 19 cm

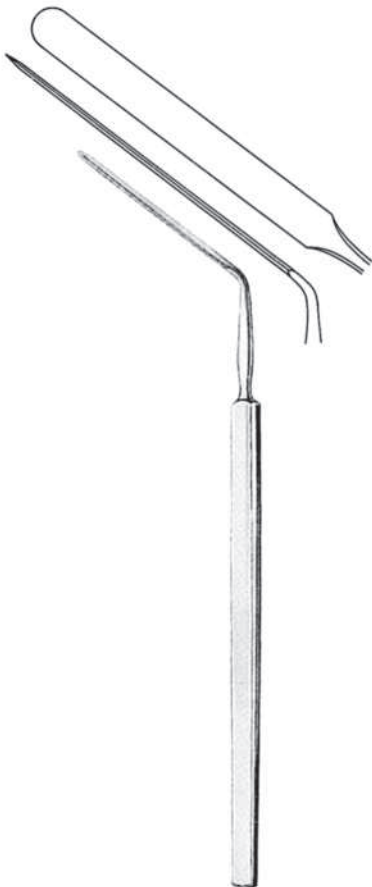

HORSLEY
 21-125-20
 20 cm

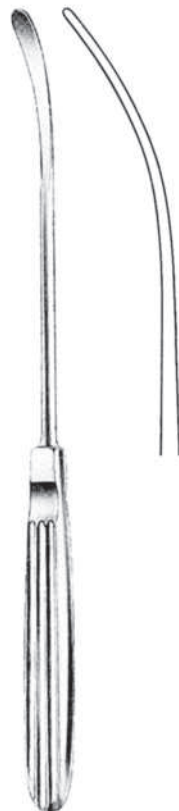

SACHA
 21-127-21
 21 cm

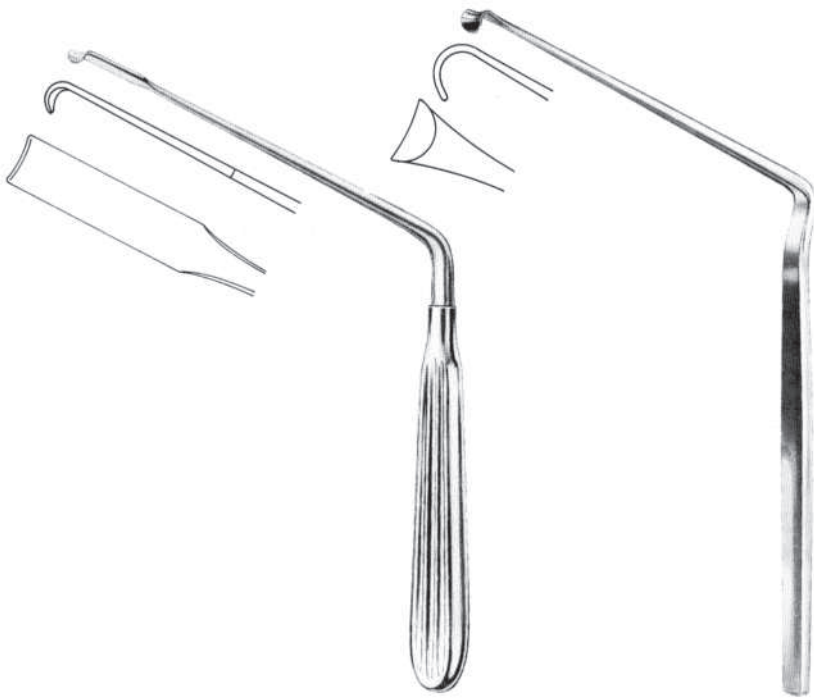

SCOVILLE
21-129-20
20 cm

MARTIN
21-131-21
21 cm

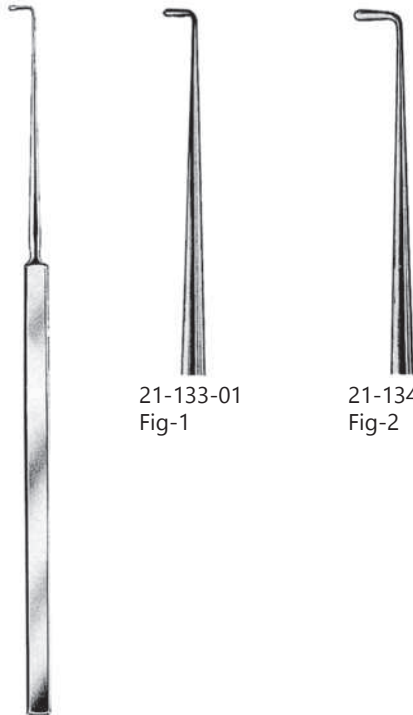

21-133-01
Fig-1

21-134-02
Fig-2

CUSHING
21-133-01 - 21-134-02
19 cm

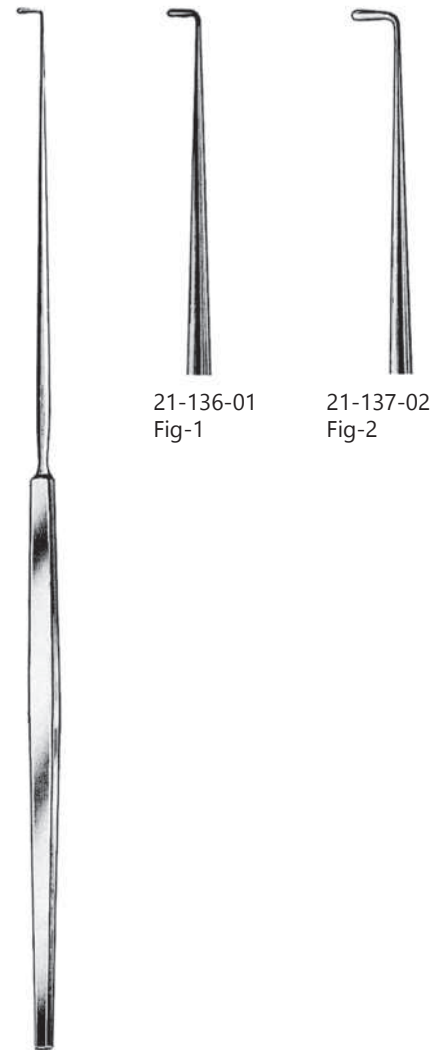

21-136-01
Fig-1

21-137-02
Fig-2

CUSHING
21-136-01 - 21-137-02
28 cm

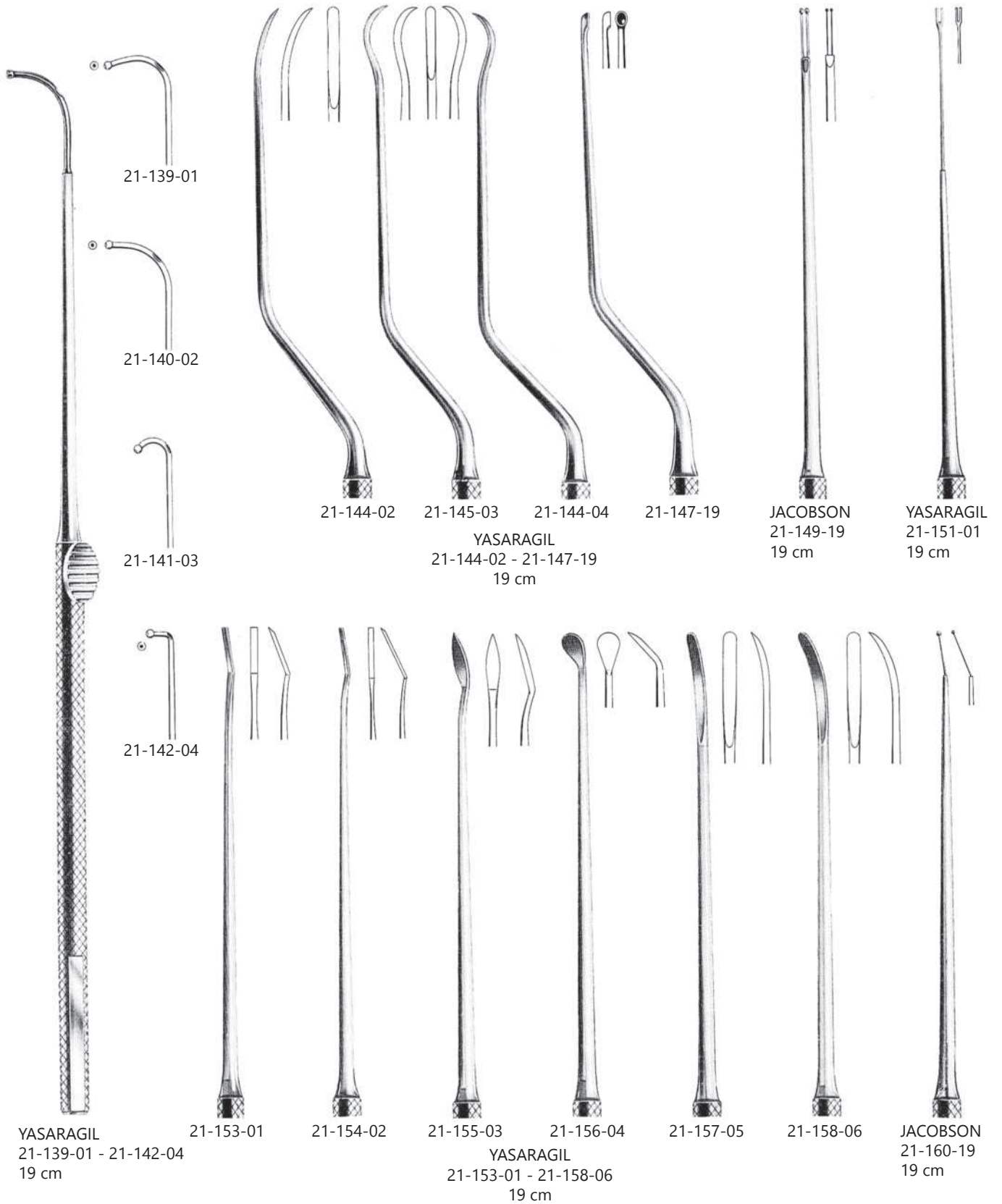



JACOBSON
21-170-19
19 cm



21-162-01



21-163-02



21-164-03



21-165-04

KRAYENBUHL
21-162-01 - 21-165-04
19 cm



21-167-19
19 cm
Dura Hook



FISCH
21-169-21
19 cm
Delicate Hook

Laterak cutting edge

Archnoid Knife



KOSS
21-171-19
19 cm



KOSS
21-173-19
19 cm

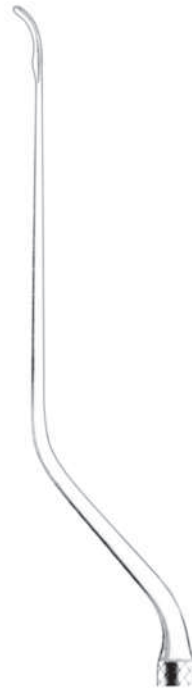

KOSS
21-175-19
19 cm



KRAUS
21-177-19
19 cm



KRAUS
21-177-19
19 cm



21-181-01
Fig-1
blunt



21-182-02
Fig-2
blunt



21-183-03
Fig-3
sharp



21-184-04
Fig-4
sharp



HARDY
21-186-25
25 cm



HARDY-FAHLBULCH
21-188-01
Fig-1
sharp



HARDY-FAHLBULCH
21-190-02
Fig-2
sharp

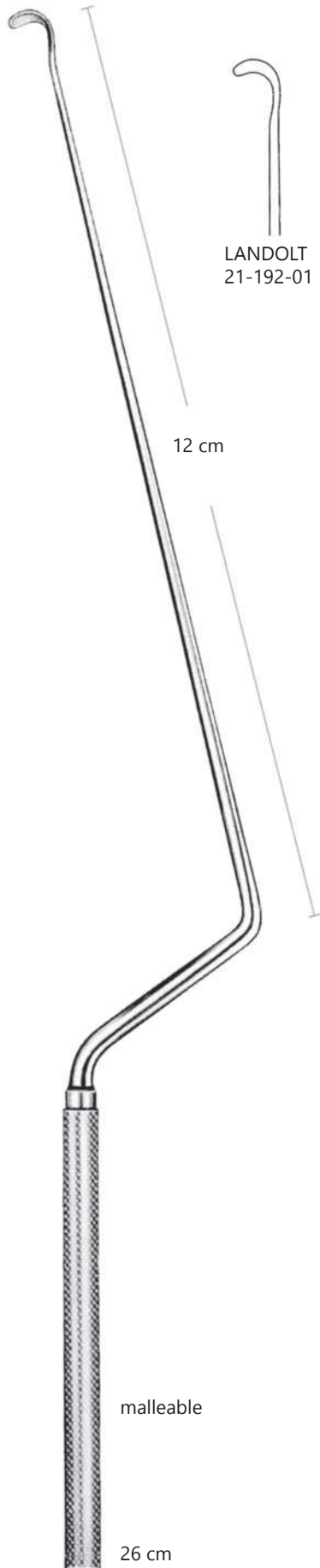

LANDOLT
21-192-01

LANDOLT
21-193-02

LANDOLT
21-194-26

LANDOLT
21-195-26

LANDOLT
21-196-26

FAHBUSCH
21-197-26

FAHBUSCH
21-198-26



HARDY
26 cm

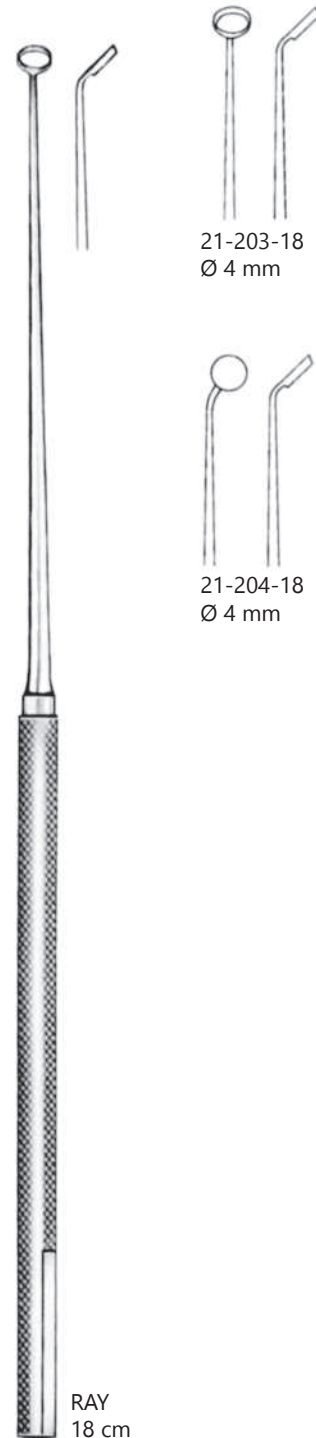

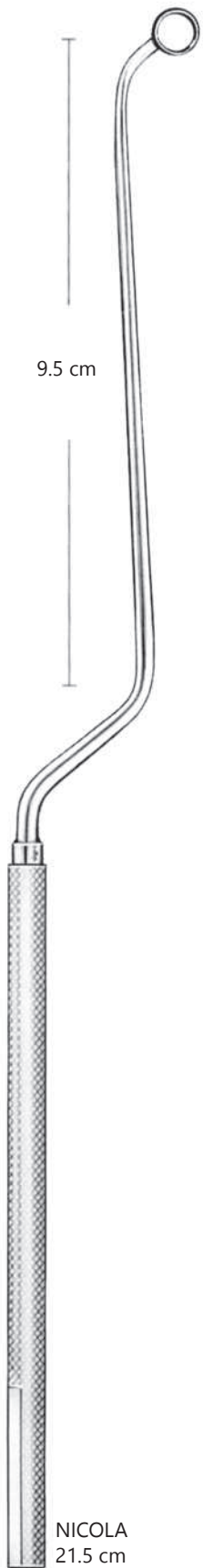

21-206-01
malleable



21-207-02
malleable



21-208-01



21-209-02



21-211-18
18 cm



21-213-18
18 cm



21-215-14
14 cm



21-217-14
14 cm



MARTEL
 21-219-93
 33 cm



21-221-01
 Fig-1



- 21-223-30 30 cm
- 21-224-40 40 cm
- 21-225-50 50 cm
- 21-226-60 60 cm
- 21-227-70 70 cm

OLIVECRONA
 21-223-30 - 21-227-70

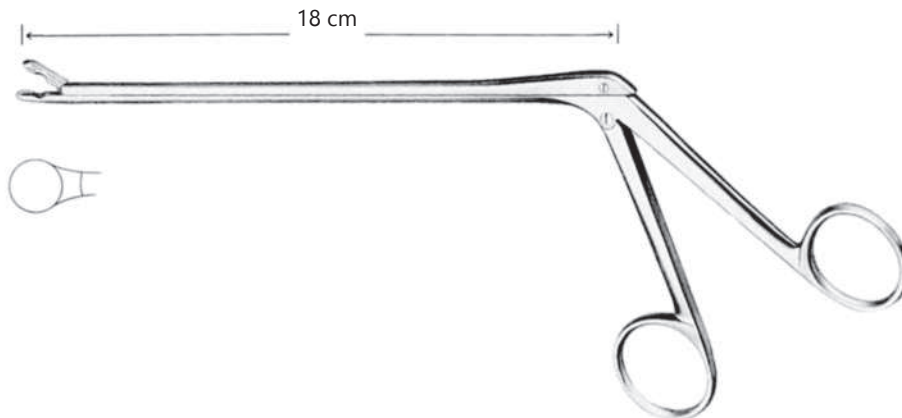

OLDBERG
 21-229-25
 21.5 cm

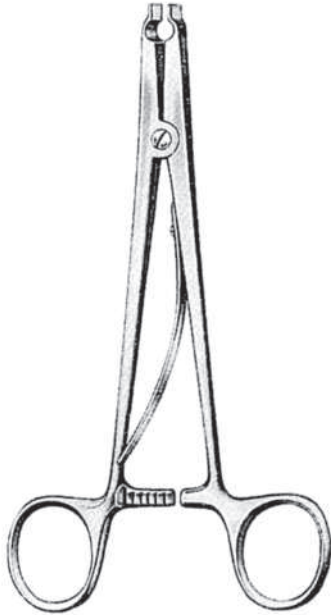

RABEY
21-231-00

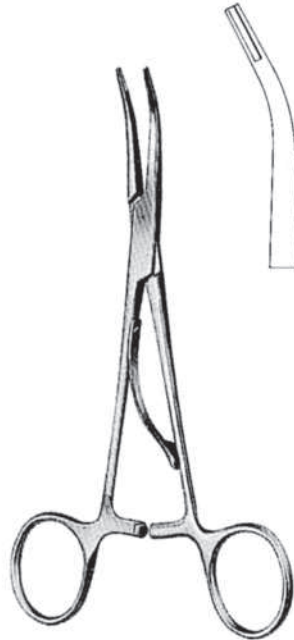

McKENZIE
21-233-15 15 cm
21-234-19 19 cm

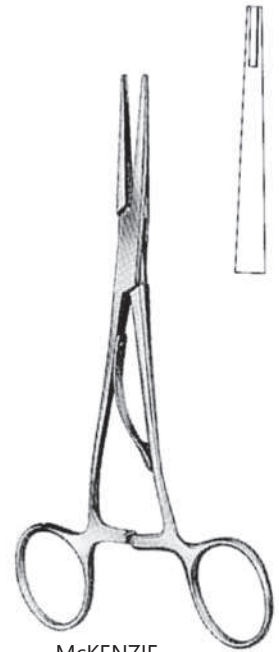

McKENZIE
21-236-15 15 cm
21-237-19 19 cm

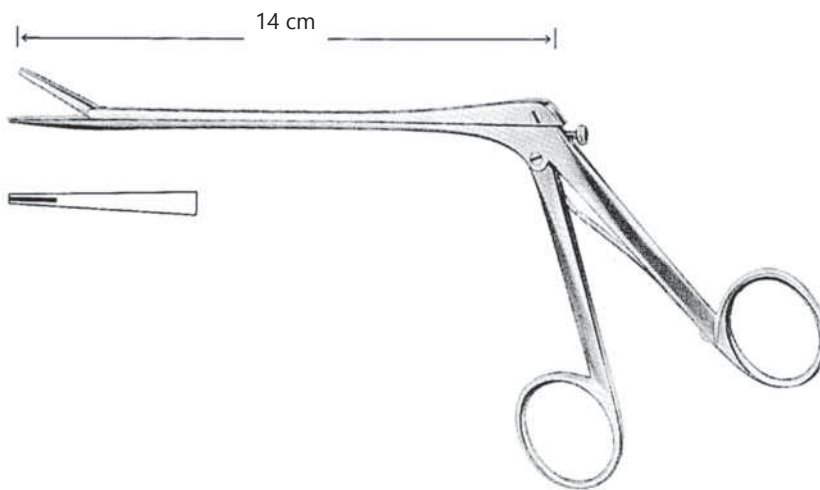

OLIVECRONA - TOENNIS
(Scoville)
21-239-14

CUSHING
2 mm



21-241-01 12 cm
 21-242-02 15 cm
 21-243-03 18 cm
 2 x 10 mm

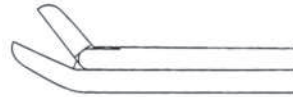

21-245-01 12 cm
 21-246-02 15 cm
 21-247-03 18 cm
 2 x 10 mm

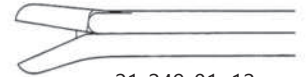

21-249-01 12 cm
 21-250-02 15 cm
 21-251-03 18 cm
 2 x 10 mm

LOVE-GRUENWALD
3 mm

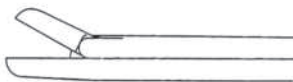

21-253-04 12 cm
 21-254-05 15 cm
 21-255-06 18 cm
 3 x 10 mm



21-257-04 12 cm
 21-258-05 15 cm
 21-259-06 18 cm
 3 x 10 mm

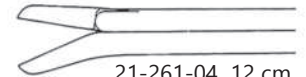

21-261-04 12 cm
 21-262-05 15 cm
 21-263-06 18 cm
 3 x 10 mm

SPURLING
4 mm



21-264-07 12 cm
 21-266-08 15 cm
 21-267-09 18 cm
 4 x 10 mm

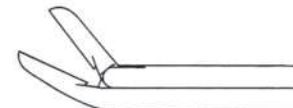

21-269-07 12 cm
 21-270-08 15 cm
 21-271-09 18 cm
 4 x 10 mm

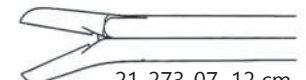

21-273-07 12 cm
 21-274-08 15 cm
 21-275-09 18 cm
 4 x 10 mm

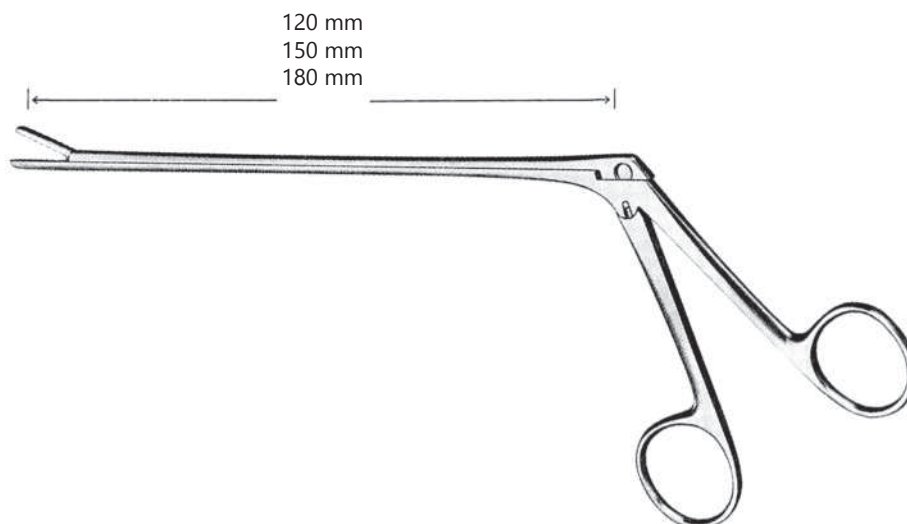

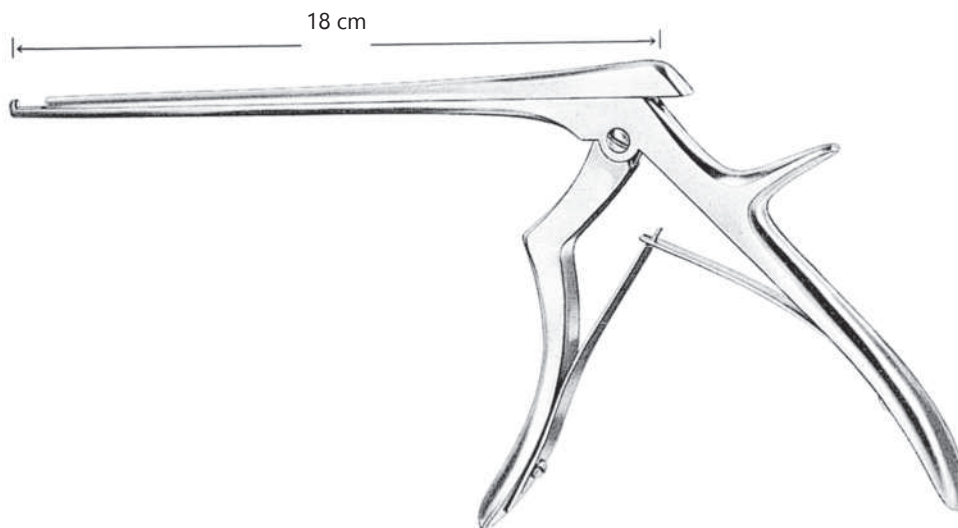
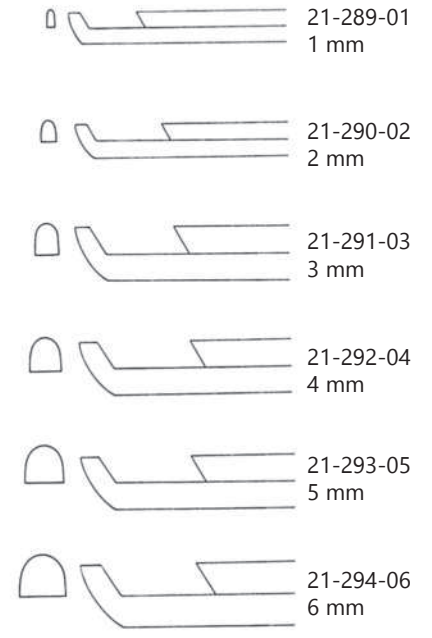
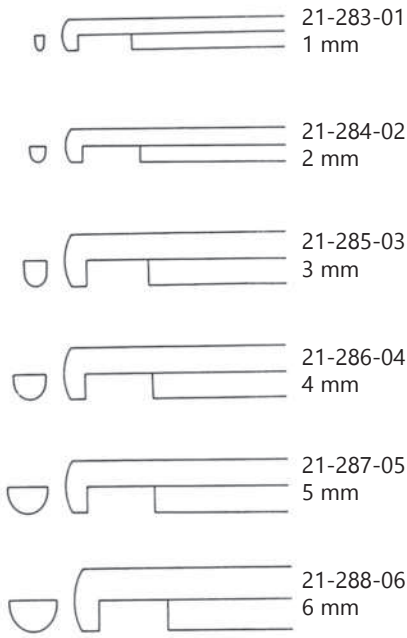
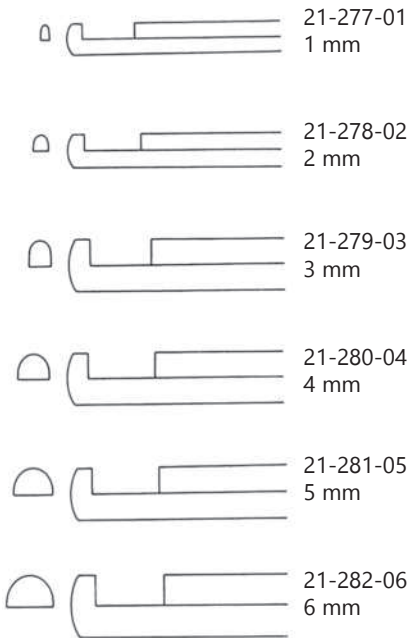

FERRIS-SMITH-KERRISON
 21-277-01 - 21-294-06



22

Dermatology - Hygiene
Dermatologie - Hygiene
Dermatología - Hygiene



22-010-16
16 cm



WARTENBERG
22-013-19
19 cm



FELDHEIM
22-015-01
10 cm

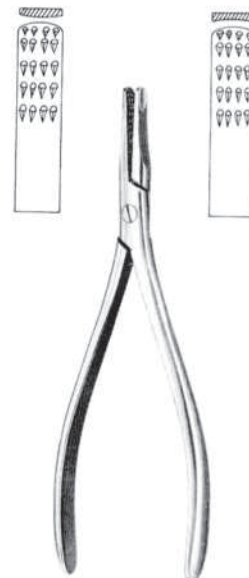

RADOLF
22-017-13
13.5 cm

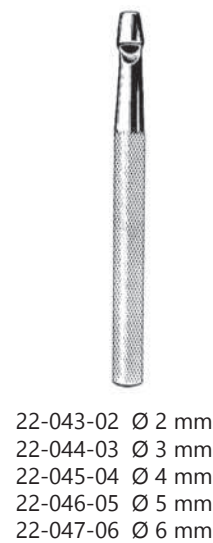
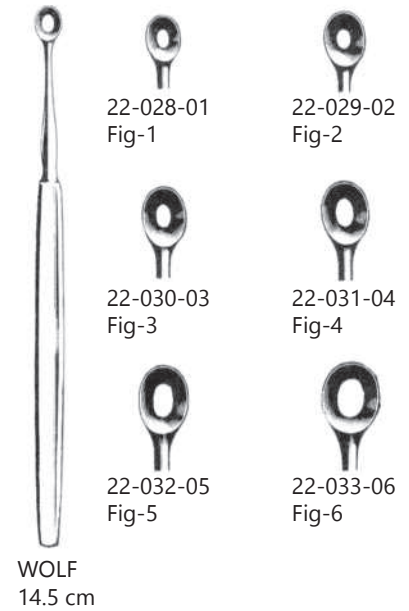
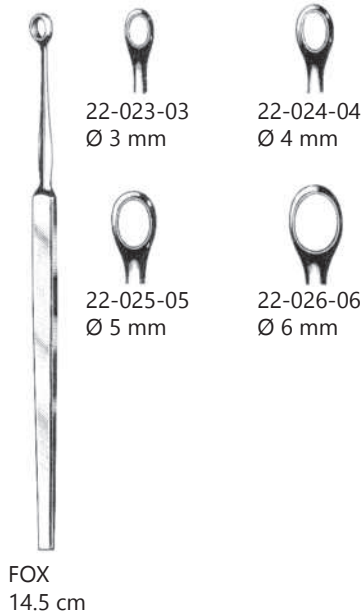
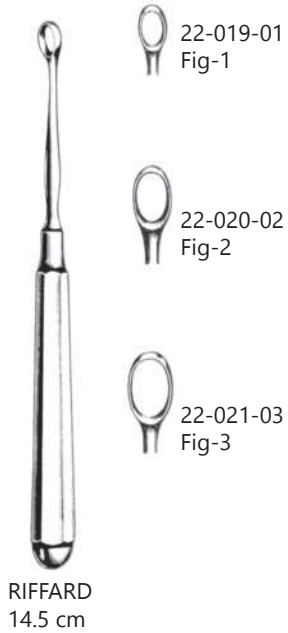

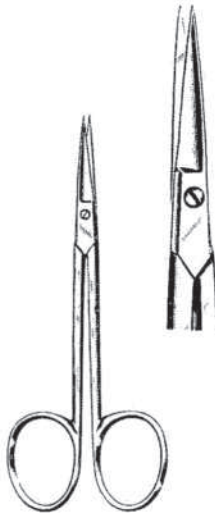

22-057-10
10.5 cm

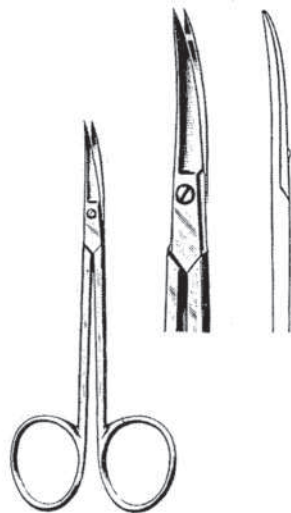

22-059-10
10.5 cm

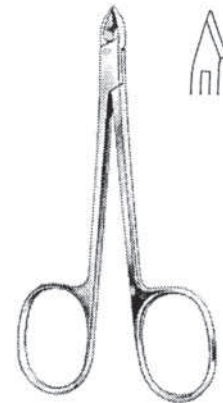

22-061-10
10.5 cm



22-063-10
10 cm



22-065-12
12 cm



22-067-11
11 cm

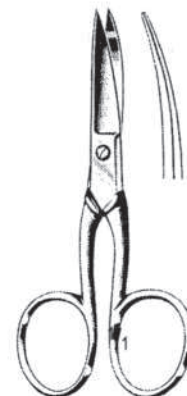

22-069-10
10 cm



22-071-12
12 cm

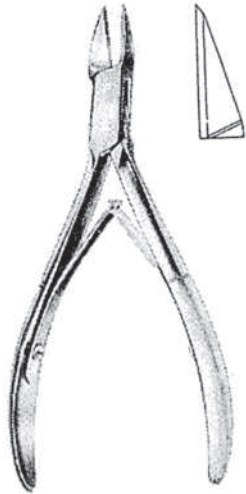

22-073-11 11 cm
22-074-13 13 cm
22-075-15 15 cm

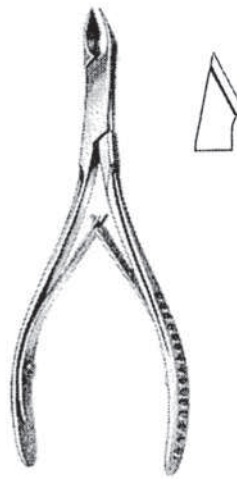

22-077-11 11 cm
22-078-13 13 cm

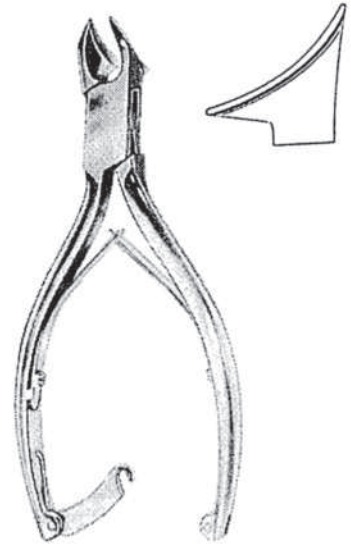

22-080-14
14 cm

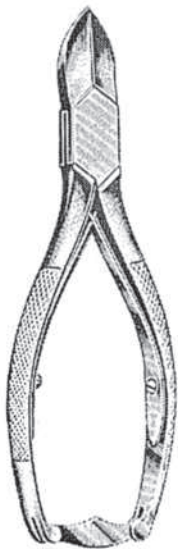

22-082-14 14 cm
22-083-16 16 cm



22-085-11 11 cm
22-086-13 13 cm
Turnbull

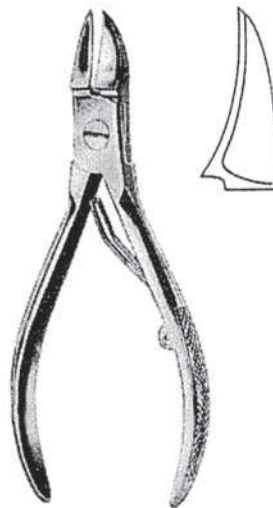

22-088-13
13 cm



61-0310-16
16 cm



23

Sterilization
Sterilisation
Esterilización



INSTRUMENTS BOXES

	L	W	H
23-010-00	17	7	3
23-011-00	17.5	7.5	3
23-012-00	18	6	3
23-013-00	18	7	3
23-014-00	18	9	4
23-015-00	20	10	4
23-016-00	21	10	4



NEEDLE CASE
 23-018-00



SYRINGE CASE
 23-020-00 5 cc
 23-021-00 2 cc



FINGER CUP
 23-023-00



INSTRUMENTS BOXES

	L	W	H
23-025-00	30 x 15	x 10	cm
23-026-00	30 x 17	x 5	cm
23-027-00	34 x 16	x 5	cm
23-028-00	36 x 24	x 5	cm
23-029-00	36 x 24	x 10	cm
23-030-00	40 x 20	x 5	cm
23-031-00	40 x 20	x 10	cm
23-032-00	40 x 30	x 5	cm
23-033-00	40 x 30	x 10	cm
23-034-00	42 x 19	x 5	cm
23-035-00	45 x 30	x 5	cm
23-036-00	45 x 30	x 10	cm

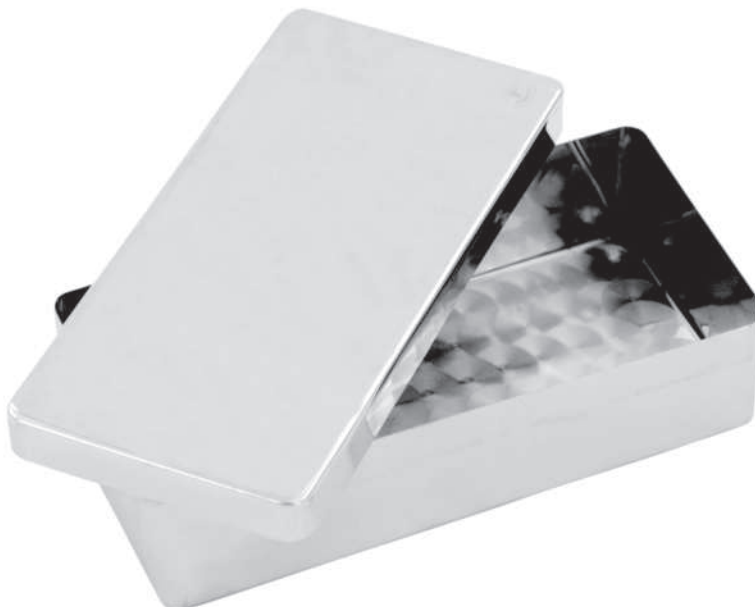

INSTRUMENTS BOXES

	L	W	H
23-038-00	12 x 8	x 3	cm
23-039-00	20 x 10	x 5	cm
23-040-00	23 x 15	x 5	cm
23-041-00	25 x 12	x 5	cm
23-042-00	25 x 12	x 10	cm
23-043-00	26 x 15	x 5	cm
23-044-00	30 x 15	x 5	cm
23-045-00	30 x 20	x 6	cm
23-046-00	32 x 8	x 4	cm



STERILIZER With HEATER
 L W H
 23-048-00 27 x 12 x 6 cm



STERILIZING/DRESSING DRUM
 23-050-00 24 x 12 cm
 23-051-00 30 x 15 cm
 23-052-00 30 x 30 cm
 23-053-00 34 x 16 cm
 23-054-00 34 x 24 cm
 23-055-00 34 x 28 cm
 23-056-00 37 x 30 cm
 23-057-00 39 x 14 cm
 23-058-00 39 x 20 cm
 23-059-00 34 x 29 cm



STERILIZING/DRESSING DRUM
 23-061-00 8 x 8 cm
 23-062-00 10 x 10 cm
 23-063-00 12 x 12 cm
 23-064-00 15 x 15 cm
 23-065-00 16 x 12 cm
 23-066-00 18 x 18 cm
 23-067-00 19 x 14 cm
 23-068-00 19 x 20 cm
 23-069-00 20 x 16 cm
 23-070-00 20 x 20 cm
 23-071-00 24 x 24 cm
 23-072-00 24 x 24 cm
 23-073-00 24 x 24 cm
 23-074-00 29 x 16 cm
 23-076-00 29 x 24 cm



BOILING STERILIZER WITH PERFORATED
 TRAY STAND AND LIFTER

	L	W	H
23-078-00	20 x	10 x	5 cm
23-079-00	25 x	12 x	5 cm
23-080-00	26 x	15 x	5 cm



COTTON/DRESSING JAR WITH LID

23-082-00	7.5 x 7.5 cm
23-083-00	10 x 10 cm
23-084-00	12.5 x 12.5 cm
23-085-00	15 x 15 cm
23-086-00	18 x 18 cm
23-087-00	10 x 12.5 cm
23-088-00	20 x 20 cm



FORCEPS JAR

23-090-00	5 x 11.5 cm
23-091-00	5 x 16.5 cm



THERMOMETER JAR

23-093-00	3 x 11 cm
-----------	-----------



LOTION BOWL
23-095-00 10 cm
23-096-00 12 cm
23-097-00 15 cm
23-098-00 20 cm
23-099-00 25 cm



MEDICINE CUP
23-100-00 50 cc
23-101-00 100 cc



LOTION CUP
23-103-00 80 x 50 mm



L W H
23-105-00 28 x 18.4 x 1 cm



L W H
23-107-00 20 x 11.5 x 2 cm



INSTRUMENTS TRAY
L W H
23-109-00 9.2 x 5.4 x 1 cm
23-110-00 15 x 10 x 1 cm
23-111-00 18.5 x 10.5 x 1 cm
23-112-00 19 x 10 x 1 cm
23-113-00 20 x 10 x 1 cm
23-114-00 20 x 15 x 1 cm
23-115-00 25 x 15 x 1 cm
23-116-00 28 x 19 x 2 cm
23-117-00 29 x 19 x 1 cm





KIDNEY TRAY
23-119-00 12 cm
23-120-00 15 cm
23-121-00 20 cm
23-122-00 25 cm
23-123-00 30 cm

www.mohsangroup.com



 **Mohsan Surgical Industries**
Butt Lodge, Daska Road, Haji Pura
Sialkot 51310 - Pakistan

 +92 524 601559

 info@mohsangroup.com

 www.mohsangroup.com